

**KATALOG**  
**2022/23**

PROFILE  
LED-LEUCHTEN  
TREIBER

# Öffnungszeiten



## unex lighting AG

Flüelastrasse 12  
CH-8048 Zürich

+41 44 404 22 22  
www.unex-lighting.com  
info@unex-lighting.com

## Öffnungszeiten

Büro/Showroom: Montag-Freitag  
07.00 – 12.00 Uhr  
13.00 – 17.00 Uhr

Lagerabholungen: 07.30 – 12.00 Uhr  
13.00 – 16.30 Uhr

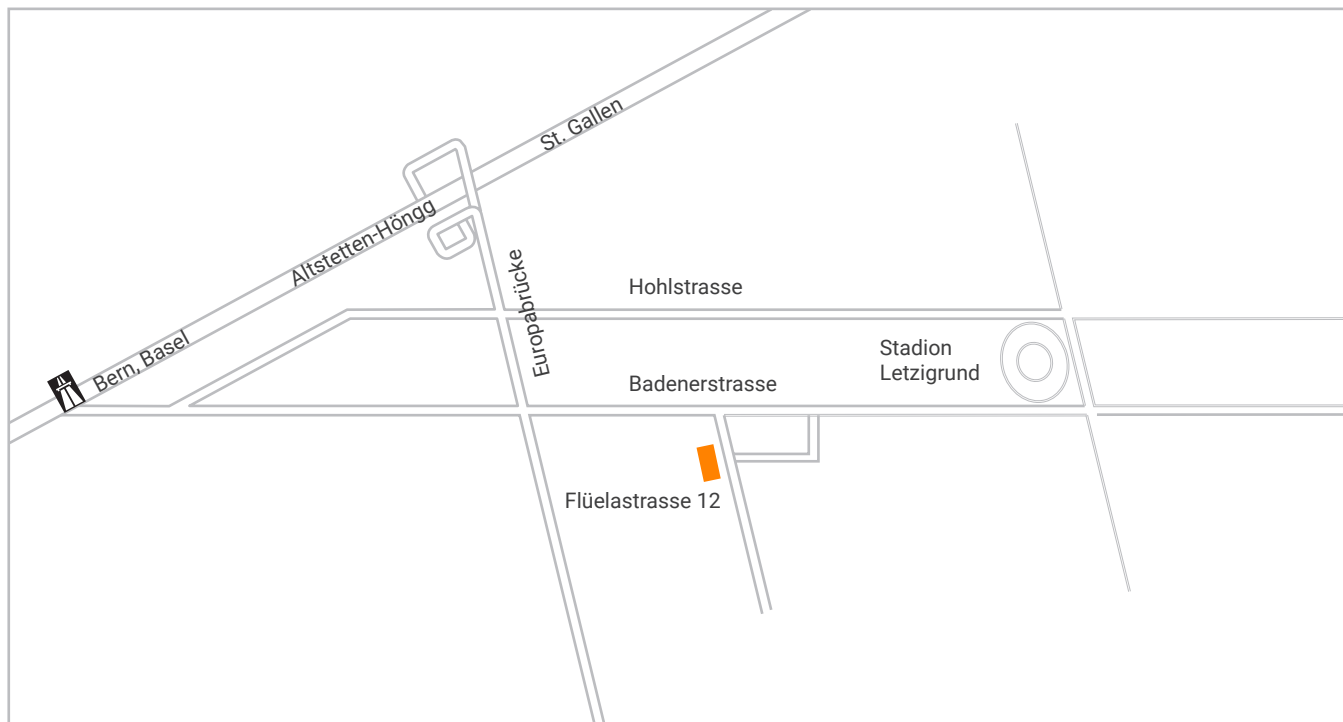

Für alle Bestellungen gelten unsere allgemeinen  
Geschäftsbedingungen (siehe Seite 424).

Sie finden diese auch unter [www.unex-lighting.com/agb](http://www.unex-lighting.com/agb)



# Inhaltsverzeichnis

<b>Produktübersicht</b>	<b>4</b>
-------------------------	----------

<b>INNEN</b>	<b>18</b>
--------------	-----------

<b>Profil-Systeme</b>	<b>18</b>
-----------------------	-----------

<b>Lineare LED-Module</b>	<b>86</b>
---------------------------	-----------

LED-Band	88
LED-Platine	102

<b>Flexible Bandleuchten</b>	<b>104</b>
------------------------------	------------

<b>Downlights</b>	<b>118</b>
-------------------	------------

Einbau-Downlight	126
Leuchtmittel	188
Deckeneinbauring	198
Aufbau-Downlight	214

<b>Einbauleuchten</b>	<b>216</b>
-----------------------	------------

Deckeneinbauleuchte	216
Wandeinbauleuchte	224

<b>Aufbauleuchten</b>	<b>228</b>
-----------------------	------------

Decken- und Wandaufbauleuchte	228
Wandaufbauleuchte	259

<b>Pendelleuchten</b>	<b>268</b>
-----------------------	------------

Pendelleuchte	268
Baldachin	274

<b>Stehleuchten</b>	<b>276</b>
---------------------	------------

<b>Strahler und Stromschienen</b>	<b>280</b>
-----------------------------------	------------

Stromschienen-System	282
Stromschienen-Strahler	288
Stromschienen-Leuchte	296

<b>Industrielleuchten</b>	<b>298</b>
---------------------------	------------

Balkenleuchte	298
Feuchtraum-Wannenleuchte	302
Hallenleuchte	304

<b>Sicherheitsleuchten</b>	<b>306</b>
----------------------------	------------

Rettungszeichenleuchte	306
------------------------	-----

<b>Möbelbeleuchtungen</b>	<b>308</b>
---------------------------	------------

Möbeleinbauleuchte	308
Möbelaufbauleuchte	312
Möbelbeleuchtungs-Set	316
Tablarbeleuchtungs-Set	318

<b>AUSSEN</b>	<b>320</b>
---------------	------------

<b>Downlights</b>	<b>322</b>
-------------------	------------

Einbau-Downlight	322
Aufbau-Downlight	324

<b>Wandeinbauleuchten</b>	<b>328</b>
---------------------------	------------

<b>Aufbauleuchten</b>	<b>334</b>
-----------------------	------------

Decken- und Wandaufbauleuchte	334
Wandaufbauleuchte	342

<b>Scheinwerfer</b>	<b>356</b>
---------------------	------------

<b>Bodeneinbauleuchten</b>	<b>360</b>
----------------------------	------------

<b>Garten- und Wegleuchten</b>	<b>368</b>
--------------------------------	------------

Erdspiessleuchte	368
Aufbauleuchte	372
Pollerleuchte	374

<b>Treiber und Steuerungen</b>	<b>380</b>
--------------------------------	------------

Steckernetzgerät	386
Tischnetzgerät	386
Konstantspannungs-Treiber	387
Konstantstrom-Treiber	396
Multi-Konstantstrom-Treiber	402
Notlichtelement	407
Touch-Dimmer	408
Steuermodul	408
Funktaster	416
Fernbedienung	418
Wand-Controller	419
Drehregler	420

<b>Zubehör</b>	<b>422</b>
----------------	------------

AGB	424
Index nach Name	426
Index nach Artikelnummer	429
Zeichenerklärung	434

## Profil-Systeme



S. 20

## Lineare LED-Module

Unex Flex  
S. 87Unex Rigid  
S. 103

## Flexible Bandleuchten

Nex Flex F23 LED  
S. 110Nex Flex F15 LED  
S. 112Nex Flex F16 LED  
S. 114Nex Flex F22 LED  
S. 116

## Downlights

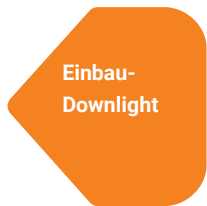
Swing 68 GU10  
S. 127Swing 68 RIDL7  
S. 128Swing 68  
S. 129Swing 68 Plan  
S. 133Swing 80 GU10  
S. 137Swing 80 RIDL7  
S. 138Swing 80  
S. 139Swing 80 Plan  
S. 143Twist 80 Plan RIDL7  
S. 146Twist 80 Plan  
S. 147Twist 80 Square  
Plan RIDL7  
S. 150

## Downlights



NEW

Twist 80 Square Plan  
S. 151



NEW

Twist 100 Plan  
S. 155



Twist 2X Square Plan  
S. 154



Swiftly LED  
S. 156



Vario LED  
S. 157



RIDL 9 Flat  
S. 158



RIDL 13 Flat  
S. 160



RIDL 8 Karda 68  
S. 163



RIDL 9 Karda 68  
S. 164



RIDL 9 Karda 80  
S. 165



NEW

Lift LED  
S. 167



NEW

Takeo Round LED  
S. 168



Flatfix Superslim II  
S. 168



EcoLED  
S. 171



NEW

RIDL Flex Round Big II  
S. 174

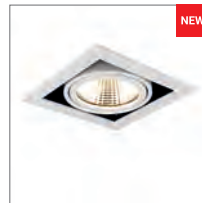

NEW

RIDL Flex Square Big II  
S. 175



NEW

RIDL Concave Big II  
S. 177



Zenta II LED  
S. 179



Zenta II Tunable White LED  
S. 181



Pico LED  
S. 183



NEW

Mira II LED  
S. 185



Leuchtmittel



RIDL 7 GU10  
S. 189



NEW

RIDL 8 II  
S. 190



RIDL 8 Dim to Warm  
S. 191



RIDL 9  
S. 192



RIDL 13  
S. 194



RIDL 13 Tunable White  
S. 195



NEW

Unex Lamp G10  
S. 196



NEW

Unex Lamp E27  
S. 196



Philips Classic LED  
S. 197



Fassung



GU10  
S. 197

## Downlights

Decken-  
einbauring



Swing 68  
S. 200



Swing 68 Plan  
S. 201



Swing 80  
S. 202



Swing 80 Plan  
S. 203



Twist 80 Plan  
S. 204



Twist 80 Square  
Plan  
S. 205



Twist 100 Plan  
S. 206



Twist 2X Square  
Plan  
S. 207



Concave  
S. 208



Mood  
S. 210



Mood Trimless  
S. 211



Disc  
S. 213

Aufbau-  
Downlight



Twist Round LED  
S. 214



Twist Square LED  
S. 214



Cilindro LED  
S. 215

## Einbauleuchten

Deckenein-  
bauleuchte



Flat LED  
S. 217



Flat Tunable White  
LED  
S. 219



Flat Short LED  
S. 221



Flat Long LED  
S. 221

Wandeinbau-  
leuchte



X LED  
S. 225



Box Asym LED  
S. 226



Box LED  
S. 227

## Aufbauleuchten



Decken- und  
Wandaufbau-  
leuchte



**Delight II LED**  
S. 229



**Crono LED**  
S. 233



**Diamond LED**  
S. 234



**Lago LED**  
S. 237



**Cloud LED**  
S. 241



**Takeo Round LED**  
S. 244



**Takeo Square LED**  
S. 246



**Culina LED**  
S. 249



**Modul 8**  
S. 250



**Modul 8 Flat**  
S. 251



**Modul 8 Round**  
S. 251

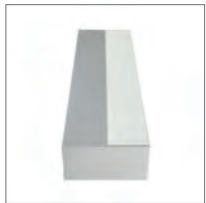

**Modular**  
S. 253



**Side**  
S. 255



**Side Round**  
S. 255



**Single LED**  
S. 257



**Twin LED**  
S. 257



Wandaufbau-  
leuchte



**Walo LED**  
S. 259



**Lim LED**  
S. 261



**Lim L LED**  
S. 261



**Asimo LED**  
S. 263

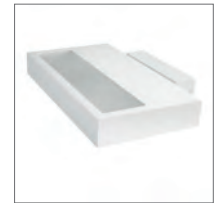

**Climb LED**  
S. 263



**Shi LED**  
S. 265



**Trina LED**  
S. 265



**Blade**  
S. 267

## Pendelleuchten

Pendel-  
leuchte



Modern II LED  
S. 271



Duplex  
S. 272



Modul 8 Flat  
S. 272



Modular 60 Square  
S. 273



Tube 35  
S. 273

Baldachin  
mit LED-  
Treiber



S. 275

## Stehleuchten



Float LED  
S. 277



Asimo LED  
S. 279

Strom-  
schienen-  
Strahler



RISP Mini GU10 One  
S. 288



RISP Mini GU10  
S. 288



RISP GU10  
S. 289



RISP 12 W One  
S. 290



RISP 12 W  
S. 290



RISP 19 W  
S. 291



RISP 33 W  
S. 292



RISP 43 W  
S. 295

Strom-  
schienen-  
Leuchte



Modul 8  
S. 296



Modern II LED  
S. 297

## Strahler und Stromschienen

Strom-  
schienen-  
System



Unex One  
S. 282



Unex  
S. 284

## Industrieleuchten

Balken-  
leuchte



Link LED  
S. 299



Line LED  
S. 301

Feuchtraum-  
Wannen-  
leuchte



Proof LED  
S. 303

Hallen-  
leuchte



Storage LED  
S. 305

## Sicherheitsleuchten

Rettungs-  
zeichen-  
leuchte



Exit LED  
S. 307

## Möbelbeleuchtungen

Möbelein-  
bauleuchte



Eye LED  
S. 309

NEW



Vario LED  
S. 310

Möbelauf-  
bauleuchte



Leezy LED  
S. 313

NEW



Flex II LED  
S. 313

Möbel-  
beleuchtungs-  
Set



Smart  
S. 316

Tablar-  
beleuchtungs-  
Set



Tablar  
S. 318



## Downlights

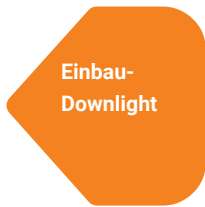

Einbau-Downlight

Polar LED  
S. 323

Aufbau-Downlight

Cilindro Outdoor LED  
S. 325Venus Round LED  
S. 327Venus Square LED  
S. 327

## Wandeinbauleuchten

L8 Rondo  
S. 328L8 Mini  
S. 329LUV II  
S. 330LUV Asym II  
S. 331L9 II  
S. 333

## Aufbauleuchten

Decken- und  
Wandaufbau-  
leuchteTura LED  
S. 334Tura Square LED  
S. 335Plate Round LED  
S. 337Plate Square LED  
S. 337Zaky Mono LED  
S. 340Zaky LED  
S. 341Wandaufbau-  
leuchteTera II 1XGU10 LED  
S. 343Tera II 2XGU10 LED  
S. 343Tera II LED  
S. 345Tom Round II LED  
S. 347Evida Round II LED  
S. 347Lim Outdoor LED  
S. 349Lim Outdoor  
Cube LED  
S. 349Square LED  
S. 351Evida Square II LED  
S. 351Coppo LED  
S. 352Turn LED  
S. 355



## Scheinwerfer



Flood LED  
S. 356



Mastro LED  
S. 358

## Bodeneinbauleuchten



Via LED  
S. 362



Via One LED  
S. 362



Via Two LED  
S. 363



Via Three LED  
S. 363



Mini LED  
S. 364



L12  
S. 365



L10 Round  
S. 366



L11 Round  
S. 366



L10 Square  
S. 367



L11 Square  
S. 367

## Garten- und Wegleuchten



Nano LED  
S. 369



Mini LED  
S. 369

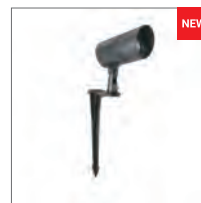

Spike II  
S. 370



Spike II  
S. 373



Tom Round II LED  
S. 374



Tom Square II LED  
S. 376



Lim LED  
S. 379



Square LED  
S. 379







# Aktueller Showroom

In unserem Showroom zeigen wir Ihnen die aktuellen Profile, LED-Leuchtmittel und Leuchten. Lassen Sie sich inspirieren und vereinbaren Sie noch heute unter der Nummer 044 404 22 22 einen Beratungstermin.



# QUALITÄT –

wir sorgen dafür

Leuchten von unex lighting stehen für Qualität.

In der Vielfalt und Dynamik des Angebotes zählt letztlich Qualität und Zuverlässigkeit über Jahre. unex lighting verfügt über zwei Labore für die lichttechnische als auch elektrotechnische Prüfung unserer und damit Ihrer Leuchten und Komponenten.

In unserem Labor erfolgt die Prüfung auf elektrostatische und elektromagnetische Verträglichkeit sowie Produktsicherheit. Tests in Wärme-, Wasser- und Staublaboren stellen die Langlebigkeit der Produkte selbst in härtesten Umgebungen sicher.

Jede unserer Leuchten durchläuft einen kompletten Prüfprozess in unserem Labor.

JAHRE  
GARANTIE\*

5

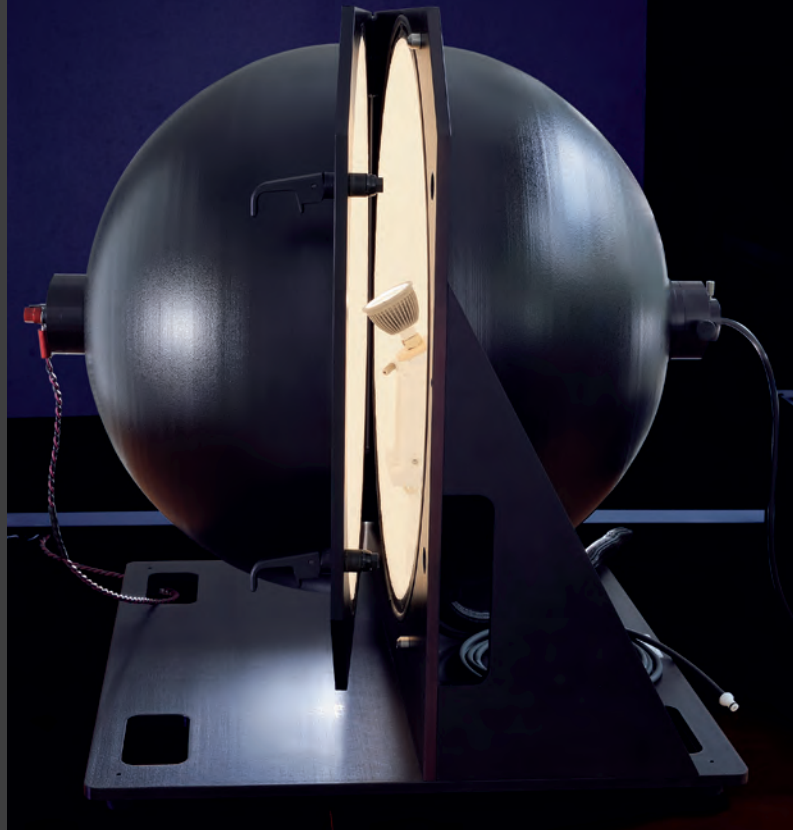

unex lighting sorgt für Ihre Qualität mit auditierten Zuliefer-Partnern, 3 eigenen Laboren und laufender Produktionsüberwachung durch unser eigenes QS-Team.



#### Angewendete Normen auszugsweise:

- Prüfung der Sicherheitsanforderungen nach EN 60598-1
- Prüfung der Störaussendung (EMV) nach EN 55015
- Prüfung der Störfestigkeit (EMV) nach EN 61547
- Prüfung der Netzrückwirkungen (EMV) nach EN 61000-3-2
- Photometrische Messungen nach EN 13032-1 und EN 13032-4
- Künstliche Bewitterung nach EN 9227

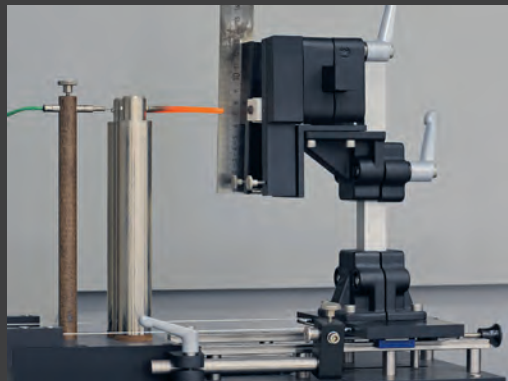

# MADE FOR YOU –

lassen Sie Ihre Lösung  
von uns nach Mass fertigen

## Ihre Vorteile:

- Kurze Lieferzeiten für massgeschneiderte Lösungen - max. 7 Werktage.
- Top Qualität – die Fertigung bei uns erfolgt ESD geschützt.
- Sie bestimmen ob teilkonfektioniert oder komplett fertig montiert.
- Sie optimieren ihre Einsatzzeiten auf der Baustelle.



# ESD-SCHUTZ- KONZEPT

**Wir sorgen für ESD geschützte Verarbeitung und Lagerung. Unsere Produktion verfügt über ein umfassendes ESD-Schutzkonzept:**

- Arbeitsplatzeinrichtung
- ESD-Schutzzone
- Personenerdung
- Verpackung und Lagerung
- Klimatisierter LED-Strip Lagerraum

# Eine neue Skala – zukunftsichere Qualität

**Planungssicherheit und zukunftsicher –** unex lighting AG hat alle Leuchten und Leuchtmittel der neuen Ökorichtlinie entsprechend angepasst und in unseren Laboren geprüft. Die Daten sind in der EPREL Datenbank hinterlegt. Setzen Sie auf unex lighting und damit auf Qualität, Zukunftssicherheit und Kompetenz.

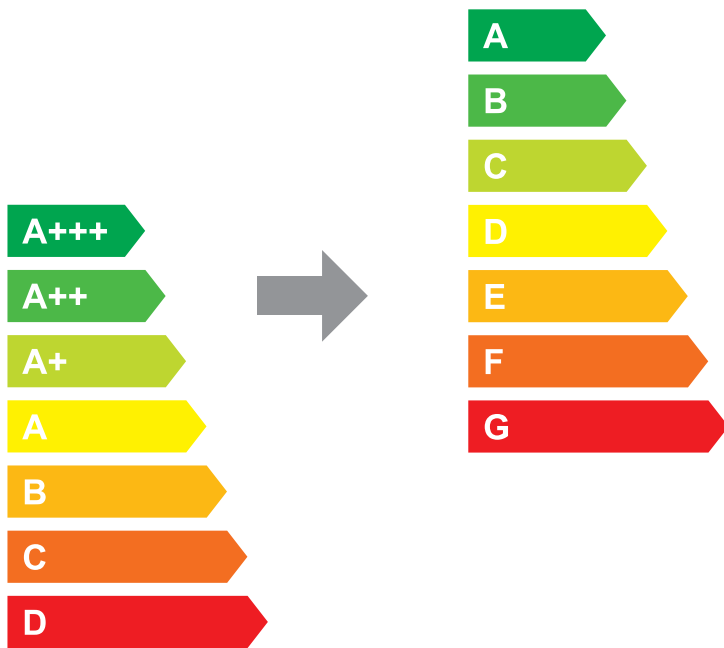

## Vorteile

- Neue Energielabel mit zukunftsicheren Kategorien
- Erhöhter Sehkomfort durch reduzierten Stroboskopeffekt und Flickering
- Geringere Netzverunreinigung durch limitierte Sinuskurvenverschiebung
- reduzierter Energieverbrauch im Standby Betrieb (max. –0.5 W anstelle bisher 1 W)
- Angaben für Austausch der Lichtquelle in der Bedienungsanleitung
- Alle Lichtquellen obligatorisch im Labor in definierten Datenkategorien gemessen
- Daten für Lichtquellen über QR-Code in der EPREL Datenbank ersichtlich

Ein bisher A+++ klassifiziertes Gerät kann neu die Energieklasse D, E oder weniger aufweisen. Damit entsteht Spielraum für effizientere Geräte in der Zukunft. Durch die neue Skalierung treten auch verschärfte Effizienzanforderungen in Kraft.

unex lighting aktualisiert und verbessert viele Produkte. In der Lichtbranche werden in der Zukunft deutlich effizientere Produkte erwartet. Die neue Skala ist darauf ausgelegt.

Durch die neue Norm ändern sich Werte bei diversen Produkten.

## Beispiel

LED-Band Unex Flex Slim, Art.-Nr. 120-103-250

Werte bisher	Werte gemäss neuer Norm
8.5 W/m	9 W/m
850 lm/m	780 lm/m

## Was ist eine Lichtquelle im Sinne der Verordnung

- über 60 lm und unter 82'000 lm
- Farbwiedergabeindex (CRI) > 0
- Farbwertanteile (CIE Farbtabelle) von 1940 bis 12'500 Kelvin
- Leuchten mit nicht austauschbaren Komponenten

## Produkte, die nicht von den Verordnungen erfasst sind

Spezielle Lichtquellen oder Lichtquellen für Spezialanwendungen wie z.B:

- Notbeleuchtung
- Signalbeleuchtung
- Farbige Lichtquellen
- Batterie- und Akkuleuchten
- Pflanzen- und Insektenlampen
- Bühnen- und Studiobeleuchtung

## Wo sind diese Informationen ersichtlich?

**Lichtquellen** Energy Label auf Verpackung mit QR-Code zu EPREL<sup>1)</sup>



**Leuchten**



**Verpackung:** Austauschbarkeits-Logo von LED-Treiber und Lichtquelle auf der Verpackung

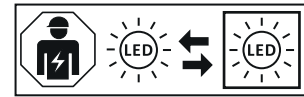

**Montageanleitung:** Verweis auf die enthaltene Lichtquelle mit der Energieeffizienzklasse

**Ausbau- und Entsorgungsanleitung:** Ausbauanleitung für die Entsorgung und Entnahme der Lichtquelle und/oder des Netzteiles auf Anfrage beim Hersteller

**Katalog**



Energieeffizienz der Lichtquelle



Der Zusatz „LED“ im Piktogramm verweist auf die Energieeffizienz der in der Leuchte verbauten Lichtquelle

Fehlt die Angabe gänzlich entspricht das Produkt noch nicht der neuen Norm.

## Zeitplan der Umsetzung

Vorher dürfen keine Lichtquellen mit neuen Etiketten im Handel ausgestellt werden.

Verbot für den Verkauf von Lichtquellen mit Etiketten nach alter Norm.

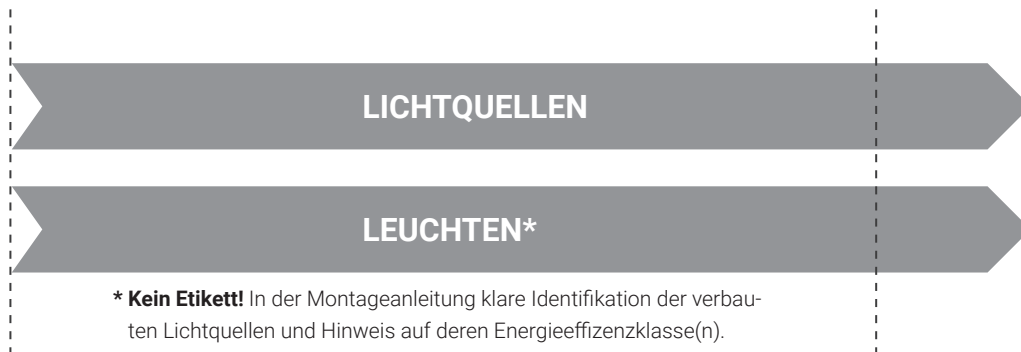

\* **Kein Etikett!** In der Montageanleitung klare Identifikation der verbauten Lichtquellen und Hinweis auf deren Energieeffizienzklasse(n).

01.09.2021

01.03.2023

<sup>1)</sup> EU Product Registration database for Energy Labelling



# Profil-Systeme – Grösstes Sortiment in höchster Qualität



Wir bieten Profil-Systeme von 9.6 mm bis 55 mm Breite. Installationen von einbetoniert, aufgebaut, in Hohldecken bis hin zu abgehängten Lösungen lassen sich damit realisieren.

Unsere Profile und Diffusoren werden nach entsprechenden Normen produziert:

- Profil: EN 755-9, EN 12020-2
- Diffusor PMMA / Polycarbonat: ISO 11359

Unterschiedliche Werkstoffe dehnen sich bei Temperaturveränderungen unterschiedlich aus. Bei einer Temperaturveränderung von 20° kann die Differenz der Ausdehnung/Schrumpfung zwischen den Materialien ca. 1,2 mm betragen und zu entsprechenden Spaltmassen bzw. Längenveränderungen führen.

Ebenso ist dies bei der Installation beispielsweise von Wand zu Wand zu beachten. Dies ist kein Produktmangel sondern ist ein materialspezifischer physikalischer Vorgang. Vorsicht: gilt auch für einbetonierte oder verputzte Installationen.

Alle unsere Profile und Diffusoren haben zwecks Zuschnitt eine Überlänge von ca. 3 mm. Muss das Profil und der Diffusor bei einer Rohmaterialbestellung (2000/3000/4000 mm) die exakte Länge aufweisen, ist dies bei der Bestellung anzugeben. Mehrkosten pro Zuschnitt: CHF 10.00.

## Wichtige Hinweise

- Profile nicht direkt anschrauben, sondern mit dem entsprechendem Zubehör fixieren.
- LED-Band nicht direkt über die Stossstellen der Profile kleben, wegen der Ausdehnung/Schrumpfung bei Temperaturschwankungen.
- An Stossstellen ist das LED-Band an den markierten Stellen zu trennen und mit flexiblen Lötbrücken mit entsprechender Dehnungsreserve (min. 5 mm) wieder zu verbinden.
- Bei einbetonierten Installationen sind Dilatationsfugen zwingend.
- Diffusoren nur mit feuchtem Tuch reinigen. Keine alkoholhaltigen Reinigungsmittel benutzen. Bei starker Verschmutzung kann eine schwache Seifenlauge verwendet werden.



### Diffusoren

Je nach Profil-System sind unterschiedliche Diffusoren erhältlich.



klar



opal

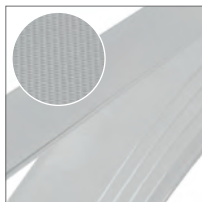

mikroprismatisch –  
gerollt



opal – gerollt

### Farben

Auf Wunsch lackieren wir Ihr Profil nach Ihren Farbangaben (RAL/NCS).

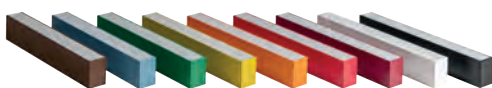

### Einbetonierhilfe

Legen Sie den Grundstein für einen sauberen Einbau des Lichtkanals mittels optionaler Einbetonierhilfe.



## Profil-Systeme

**Slim** S. 26    **Slick** S. 28    **Planar** S. 30    **Aski** S. 32



9.6 x 12 mm



14 x 14 mm

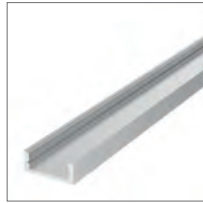

17.5 x 7 mm



17.5 x 7 mm,  
mit Kragen



20 x 14 mm

**Slight** S. 36    **Bow** S. 38    **Basic 18** S. 40



22.6 x 8.5 mm



22.6 x 15.6 mm



24.5 x 7.7 mm



18 x 19 mm

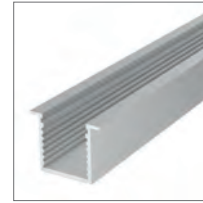

18 x 19 mm,  
mit Kragen



18 x 20 mm,  
mit Kragen

**Combo 20** S. 42    **Combo 30** S. 44    **Linea 20** S. 46    **Linea 25** S. 48    **Linea 25 High** S. 50

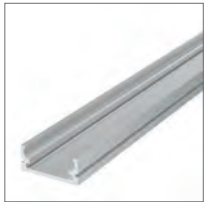

20 x 8.5 mm



20 x 20 mm



30 x 18 mm



20 x 10 mm



25 x 12.5 mm



25 x 23 mm

**Linea 30 II** S. 52    **Basic 30** S. 54    **Duplex** S. 56    **Basic 35** S. 58    **Modular 18** S. 60



30 x 30 mm



30 x 30 mm



22.6 x 34 mm



35 x 35 mm

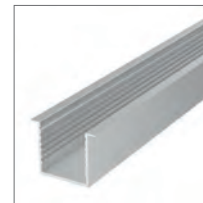

35 x 35 mm,  
mit Kragen



40 x 18 mm

**Modular 42**

S. 64



40 x 42 mm

**Modular 60**

S. 68



40 x 60 mm

**Tek 1**

S. 70



54 x 70 mm

**Tek 2**

S. 71

55 x 35 mm,  
mit Kragen**Edge**

S. 72



26.25 x 15.08 mm

**Corner 16**

S. 74



16 x 16 mm

**Corner 30**

S. 76



30 x 30 mm

**Tube 16**

S. 78



Ø 16 mm

**Tube 26**

S. 80



Ø 26 mm

**Tube 35**

S. 82



Ø 35 mm

**Tube 60**

S. 83



Ø 60 mm

**Blade Mini**

S. 84



21.5 x 60 mm

**Blade**

S. 85



41.6 x 102 mm





# Kompatibilität auf einen Blick – Welche Seilabhängung passt zu welchem Profil?

## Seilabhängungen

		290-003-00 L = 2500 mm Ø = 1.5 mm 25 kg	290-015-00 L = 5000 mm Ø = 1.5 mm 25 kg	290-002-00 L = 2000 mm Ø = 1.0 mm 13 kg	290-001-00 L = 1900 mm Ø = 1.0 mm 7 kg max. 150 W	290-001-01 L = 2500 mm Ø = 1.55 mm 1.5 kg max. 140 W	100-001-003 L = 2000 mm Ø = 1.4 mm 17.5 kg	100-004-003 L = 2000 mm Ø = 1.4 mm 17.5 kg
Stromführung im Seil	ummantelt				■	■		
	dimmbar				■	■	■	■
<b>Profil-Systeme</b>								
<b>Linea 20</b>	20 x 10	■ 1)	■ 1)		■ 1)	■ 1)		
<b>Linea 25</b>	25 x 12.5	■ 2)	■ 2)			■ 2)		
<b>Linea 25 High</b>	25 x 23	■ 2)	■ 2)			■ 2)		
<b>Linea 30 II</b>	30 x 30	■ 1)	■ 1)			■ 1)		
<b>Duplex</b>	22.6 x 34	■ 3)	■ 3)			■ 3)		
<b>Modular 18</b>	40 x 18			■ 5)				
<b>Modular 42</b>	40 x 42	■ 4)	■ 4)	■ 4)		■ 4)		
	40 x 42, + H-Profil	■ 4)	■ 4)	■ 4)		■ 4)		
<b>Modular 60</b>	40 x 60	■ 4)	■ 4)	■ 4)		■ 4)		
<b>Tek 1</b>	54 x 70						■ 5)	
<b>Tube 35</b>	Ø 35					■ 1)		
<b>Tube 60</b>	Ø 60							■ 5)

1) mit Befestigungsklammer

2) mit Befestigungselement Linea 25 (Artikel-Nr. 100-008-200)

3) mit Befestigungselement Duplex (Artikel-Nr. 100-226-200)

4) mit Befestigungselement Modular (Artikel-Nr. 290-020-00)

5) wird direkt am Profil befestigt





	<b>Linea 25</b> S. 48	<b>Linea 30 II</b> S. 52	<b>Modular 18</b> S. 60	<b>Modular 60</b> S. 68	<b>Tube 35</b> S. 82
<b>Linea 20</b> S. 46	<b>Linea 25 High Duplex</b> S. 50	<b>Duplex</b> S. 56	<b>Modular 42</b> S. 64	<b>Tek 1</b> S. 70	<b>Tube 60</b> S. 83

## Slim | Profil-System

Das Profil für die Holznut

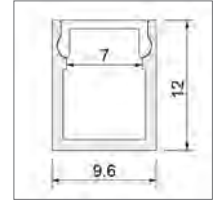

9.6 x 12 mm

### Anwendungsbeispiele

- Möbelbeleuchtung
- Regalbeleuchtung
- Sockelbeleuchtung

### Informationen

- für Akzentbeleuchtung
- für Einbau in Holznut
- nur in Kombination mit LED-Band Unex Flex Slim

### Profile



#### U-Profil

Aluminium, eloxiert

Länge	Art.-Nr.	CHF
2000 mm	359-096-012	19.00/m
3000 mm	359-096-013	19.00/m

### Diffusoren



#### Diffusor

Polycarbonat, opal

Länge	Art.-Nr.	CHF
2000 mm	411-096-062	20.90/m
3000 mm	411-096-063	20.90/m

### Endkappen



#### Endkappe

Kunststoff

Variante	Art.-Nr.	CHF
	6682-096-000	4.20

### Zubehör



#### Befestigungsklammer

Federstahl, für horizontale oder vertikale Befestigung

Variante	Art.-Nr.	CHF
	26491-096-100	5.20



#### L-Halterung

Stahl

Variante	Art.-Nr.	CHF
	290-016-00	4.20





## Slick | Profil-System

passt in die Nut

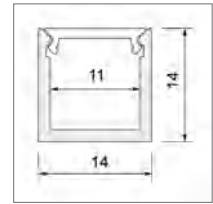

14 x 14 mm

### Anwendungsbeispiele

- Küchen
- Bars und Restaurants
- Architekturbeleuchtung
- Möbelbeleuchtung
- Sockelbeleuchtung

### Informationen

- auch mit RGB- und TW-Bänder kombinierbar
- für Akzentbeleuchtung
- für Einbau in Holznut

### Profile



#### U-Profil

Aluminium, eloxiert

Länge	Art.-Nr.	CHF
3000 mm	100-012-013	21.90/m

### Diffusoren

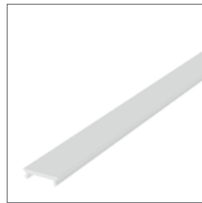

#### Diffusor

PMMA, opal

Länge	Art.-Nr.	CHF
3000 mm	100-012-063	21.90/m

### Endkappen

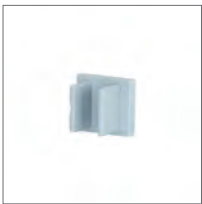

#### Endkappe

Kunststoff

Variante	Art.-Nr.	CHF
	100-012-000	4.20

### Zubehör



#### Befestigungsklammer

Federstahl, für horizontale oder vertikale Befestigung

Variante	Art.-Nr.	CHF
	100-012-100	5.20



#### L-Halterung

Stahl

Variante	Art.-Nr.	CHF
	290-016-00	4.20





## Planar | Profil-System

Das vielseitige für Möbel und Regale

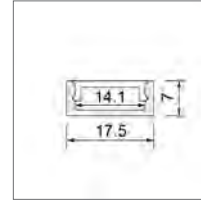

17.5 x 7 mm

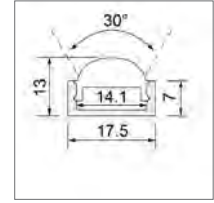

17.5 x 13 mm

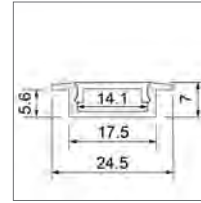

17.5 x 7 mm,  
mit Kragen

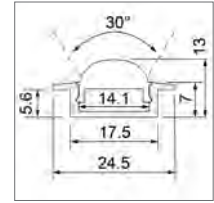

17.5 x 13 mm,  
mit Kragen

### Anwendungsbeispiele

- Küchen
- Vitrinen
- Treppenhäuser und Flure
- Treppenstufen und Handläufe
- Unterschrankbeleuchtung

### Informationen

- auch mit 30° Optik - ideal für Wandbeleuchtung
- für Indirektbeleuchtung
- für Akzentbeleuchtung
- für Einbau in Hohldecken (Holz, Gips)

### Profile

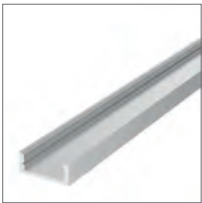

#### U-Profil

Aluminium, eloxiert

Länge	Art.-Nr.	CHF
2000 mm	359-175-012	25.00/m
3000 mm	359-175-013	25.00/m



#### U-Profil mit Kragen

Aluminium, eloxiert

Länge	Art.-Nr.	CHF
2000 mm	359-175-022	25.00/m
3000 mm	359-175-023	25.00/m

### Diffusoren



#### Diffusor

Polycarbonat, opal

Länge	Art.-Nr.	CHF
2000 mm	411-175-062	24.00/m
3000 mm	411-175-063	24.00/m



#### Diffusor

PMMA, 10% satiniert, 30°

Länge	Art.-Nr.	CHF
3000 mm	411-175-083	36.90/m

### Endkappen



#### Endkappe

Kunststoff

Variante	Art.-Nr.	CHF
	960-175-000	4.20



#### Endkappe, für U-Profil mit Kragen

Kunststoff

Variante	Art.-Nr.	CHF
	960-175-001	4.20



#### Befestigungsklammer

Federstahl, für horizontale oder vertikale Befestigung

Variante	Art.-Nr.	CHF
	26491-175-100	5.20



**Planar | Profil-System**

## Aski | Profil-System

asymmetrische Lichtverteilung in kleinster Bauform

NEW

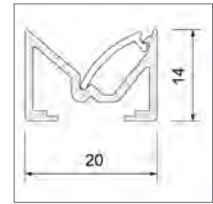

20 x 14 mm

### Anwendungsbeispiele

- Küchen
- Vitrinen
- Möbelbeleuchtung
- Wandbeleuchtung
- Regalbeleuchtung

### Informationen

- asymmetrischer Lichtaustritt
- für Akzentbeleuchtung
- für Einbau in Holznut
- Aufbau mit Befestigungsklammern
- entwickelt in Kooperation mit Saturday Design

### Profile



#### U-Profil

Aluminium, eloxiert

Länge	Art.-Nr.	CHF
3000 mm	100-013-013	26.50/m

### Diffusoren



#### Diffusor

PMMA, opal

Länge	Art.-Nr.	CHF
3000 mm	100-013-063	26.50/m

### Endkappen



#### Endkappe

Kunststoff

Variante	Art.-Nr.	CHF
	100-013-000	4.50

### Zubehör



#### Profilverbinder

Aluminium, inkl. Schrauben

Variante	Art.-Nr.	CHF
	100-013-025	18.70



#### Befestigungsklammer

Federstahl, für horizontale oder vertikale Befestigung

Variante	Art.-Nr.	CHF
	100-013-100	5.50



#### L-Halterung

Stahl

Variante	Art.-Nr.	CHF
	290-016-00	4.20







Profil-System  
**Slight**







## Slight | Profil-System

ganz kompakt bis 24 W

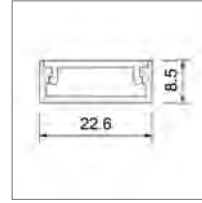

22.6 x 8.5 mm

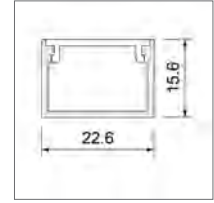

22.6 x 15.6 mm

### Anwendungsbeispiele

- Küchen
- Vitrinen
- Möbelbeleuchtung
- Sockelbeleuchtung
- Treppenstufen und Handläufe
- Unterschrankbeleuchtung

### Informationen

- für Akzentbeleuchtung

### Profile



#### U-Profil, 8.5

Aluminium, eloxiert

Länge	Art.-Nr.	CHF
2000 mm	359-226-012	30.90/m
3000 mm	359-226-013	30.90/m



#### U-Profil, 15.6

Aluminium, eloxiert

Länge	Art.-Nr.	CHF
2000 mm	359-228-012	30.90/m
3000 mm	359-228-013	30.90/m

### Diffusoren



#### Diffusor

PMMA, opal

Länge	Art.-Nr.	CHF
2000 mm	411-226-062	26.20/m
3000 mm	411-226-063	26.20/m

### Endkappen



#### Endkappe, für U-Profil 8.5

Kunststoff

Variante	Art.-Nr.	CHF
	960-226-000	4.20



#### Endkappe, für U-Profil 15.6

Kunststoff

Variante	Art.-Nr.	CHF
	960-228-000	4.20

## Slight | Profil-System

### Zubehör

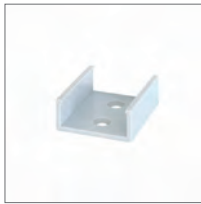

#### Befestigungsklammer, für U-Profil 8.5

Kunststoff, für horizontale Befestigung

Variante	Art.-Nr.	CHF
	960-226-100	5.20



#### Befestigungsklammer, für U-Profil 15.6

Kunststoff, für horizontale Befestigung

Variante	Art.-Nr.	CHF
	960-228-100	5.20



#### L-Halterung

Stahl

Variante	Art.-Nr.	CHF
	290-016-00	4.20



## Bow | Profil-System

schlank und doch bis 24 W

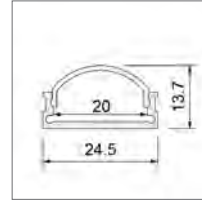

24.5 x 13.7 mm

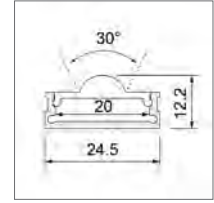

24.5 x 12.2 mm

### Anwendungsbeispiele

- Architekturbeleuchtung
- Badezimmer
- Küchen
- Treppenhäuser und Flure
- Bars und Restaurants

### Informationen

- auch mit 30° Optik - ideal für Wandbeleuchtung
- für Indirektbeleuchtung
- für Akzentbeleuchtung
- auch mit RGB-, RGBW- und TW-Bänder kombinierbar

- homogene Lichtverteilung, auch mit leistungsstarken LED-Bänder (24 W/m)

### Profile



#### U-Profil

Aluminium, eloxiert

Länge	Art.-Nr.	CHF
3000 mm	936-040-080	26.20/m

### Diffusoren und Abdeckungen



#### Abdeckung

Aluminium

Länge	Art.-Nr.	CHF
3000 mm	936-026-033	10.60/m



#### Diffusor

PMMA, satinierter

Länge	Art.-Nr.	CHF
3000 mm	936-026-053	26.20/m



#### Diffusor

PMMA, opal

Länge	Art.-Nr.	CHF
3000 mm	936-026-063	26.20/m



#### Diffusor

PMMA, satinierter, 30°

Länge	Art.-Nr.	CHF
3000 mm	936-026-083	36.90/m

### Endkappen



#### Endkappe

Aluminium, inkl. Schrauben

Variante	Art.-Nr.	CHF
	936-040-000	5.20



## Bow | Profil-System

## Zubehör

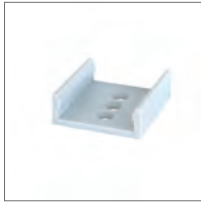
**Befestigungsklammer**

Kunststoff, für horizontale Befestigung

Variante	Art.-Nr.	CHF
	936-040-100	5.20

**L-Halterung**

Stahl

Variante	Art.-Nr.	CHF
	290-016-00	4.20

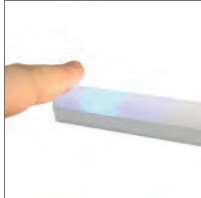
**Touch-Dimmer**

PWM-Dimmung (max. 3A), fertig montiert unter Diffusor, mit kapazitiver Taste

Variante	Art.-Nr.	CHF
	UD-210-002-00	• 54.00



## Basic 18 | Profil-System

schlank und vielseitig bis hin zu Sichtbeton

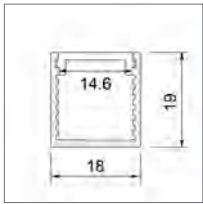

18 x 19 mm

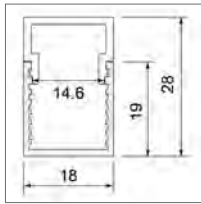

18 x 28 mm

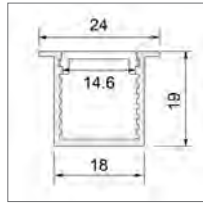

18 x 19 mm,  
mit Kragen

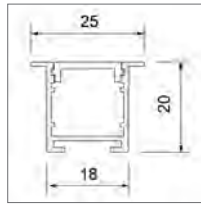

18 x 20 mm,  
mit Kragen,  
für Hohldecken

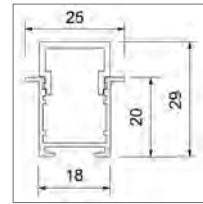

18 x 29 mm,  
mit Kragen,  
für Hohldecken

### Anwendungsbeispiele

- Vitrinen
- Möbelbeleuchtung
- Regalbeleuchtung
- Sockelbeleuchtung
- Treppenstufen und Handläufe
- Unterschrankbeleuchtung

### Informationen

- für Akzentbeleuchtung
- für Einbau in Hohldecken (Holz, Gips)
- Einbetonierhilfe erhältlich

### Profile



#### U-Profil

Aluminium, eloxiert

Länge	Art.-Nr.	CHF
2000 mm	359-180-012	27.70/m
3000 mm	359-180-013	27.70/m

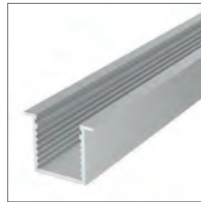

#### U-Profil mit Kragen

Aluminium, eloxiert

Länge	Art.-Nr.	CHF
2000 mm	359-180-022	27.70/m
3000 mm	359-180-023	27.70/m
4000 mm	359-180-024	27.70/m



#### U-Profil mit Kragen, für Hohldecken

Aluminium, eloxiert

Länge	Art.-Nr.	CHF
3000 mm	100-017-013	29.00/m

### Diffusoren



#### Diffusor

PMMA, opal

Länge	Art.-Nr.	CHF
2000 mm	411-180-062	26.20/m
3000 mm	411-180-063	26.20/m
4000 mm	411-180-064	26.20/m



#### Diffusor, 9

PMMA, opal, für U-Profil und U-Profil mit Kragen für Hohldecken

Länge	Art.-Nr.	CHF
3000 mm	100-017-063	29.50/m

## Basic 18 | Profil-System

### Endkappen



**Endkappe**  
Kunststoff

Variante	Art.-Nr.	CHF
	960-180-000	4.20



**Endkappe, für Diffusor 9**  
Kunststoff

Variante	Art.-Nr.	CHF
	960-180-002	4.50



**Endkappe, für U-Profil mit Kragen**  
Kunststoff

Variante	Art.-Nr.	CHF
	960-180-001	3.90



**Endkappe, für U-Profil mit Kragen, für Hohldecken**  
Kunststoff

Variante	Art.-Nr.	CHF
	100-017-000	4.20



**Endkappe, für U-Profil mit Kragen, für Hohldecken und Diffusor 9**  
Kunststoff

Variante	Art.-Nr.	CHF
	100-017-001	4.50

### Zubehör



**Profilverbinder**  
Aluminium, für U-Profil mit Kragen, für Hohldecken, inkl. Schrauben

Variante	Art.-Nr.	CHF
	100-017-025	18.70



**Befestigungsklammer**  
Federstahl, für horizontale oder vertikale Befestigung

Variante	Art.-Nr.	CHF
	26491-180-100	5.20



**Hohldecken-Einbauhalterung**  
für U-Profil mit Kragen, für Hohldecken, inkl. Schrauben

Variante	Art.-Nr.	CHF
	100-017-100	7.90



**Einbetonierhilfe**  
Kunststoff, BxH: 21.5 x 22 mm, für Putzdecke, leicht konisch für eine einfachere und schnellere Ausschalung

Länge	Art.-Nr.	CHF
3000 mm	960-180-213	96.00



## Combo 20 | Profil-System

Diffusor pur – kein Profil von vorne sichtbar

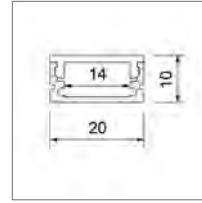

20 x 10 mm

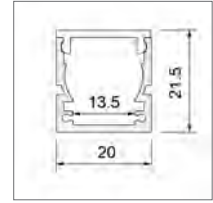

20 x 21.5 mm

### Anwendungsbeispiele

- Badezimmer
- Küchen
- Vitrinen
- Möbelbeleuchtung
- Sockelbeleuchtung
- Unterschrankbeleuchtung

### Informationen

- für Indirektbeleuchtung
- für Akzentbeleuchtung

### Profile



#### U-Profil, 8.5

Aluminium, eloxiert

Länge	Art.-Nr.	CHF
2000 mm	936-200-012	27.70/m
3000 mm	936-200-013	27.70/m



#### U-Profil, 20

Aluminium, eloxiert

Länge	Art.-Nr.	CHF
3000 mm	936-202-013	30.90/m

### Diffusoren



#### Diffusor

Polycarbonat, klar

Länge	Art.-Nr.	CHF
3000 mm	936-202-053	26.20/m

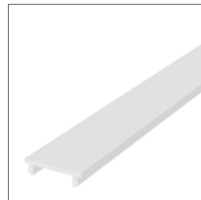

#### Diffusor

Polycarbonat, opal

Länge	Art.-Nr.	CHF
2000 mm	936-202-062	26.20/m
3000 mm	936-202-063	26.20/m

### Endkappen



#### Endkappe, für U-Profil 8.5

Kunststoff

Variante	Art.-Nr.	CHF
	936-200-000	5.20



#### Endkappe, für U-Profil 20

Kunststoff

Variante	Art.-Nr.	CHF
	936-202-000	4.20

### Zubehör

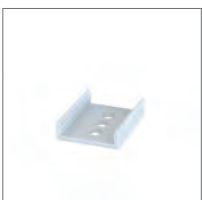

#### Befestigungsklammer, für U-Profil 8.5

Kunststoff, für horizontale Befestigung

Variante	Art.-Nr.	CHF
	936-200-100	5.20



#### Befestigungsklammer, für U-Profil 20

Kunststoff, für horizontale Befestigung

Variante	Art.-Nr.	CHF
	936-202-100	5.20



## Combo 20 | Profil-System

### Zubehör



#### L-Halterung

Stahl

Variante	Art.-Nr.	CHF
	290-016-00	4.20



## Combo 30 | Profil-System

Diffusor pur – kein Profil von vorne sichtbar

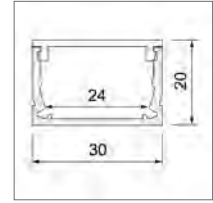

30 x 20 mm

### Anwendungsbeispiele

- Küchen
- Bars und Restaurants
- Regalbeleuchtung
- Sockelbeleuchtung
- Treppenstufen und Handläufe
- Unterschrankbeleuchtung

### Informationen

- für Akzentbeleuchtung

### Profile



#### U-Profil

Aluminium, eloxiert

Länge	Art.-Nr.	CHF
3000 mm	936-318-013	32.00/m

### Diffusoren



#### Diffusor

Polycarbonat, opal

Länge	Art.-Nr.	CHF
3000 mm	936-318-063	30.50/m

### Endkappen



#### Endkappe

Kunststoff

Variante	Art.-Nr.	CHF
	936-318-000	4.20

### Zubehör



#### Befestigungsklammer

Kunststoff, für horizontale Befestigung

Variante	Art.-Nr.	CHF
	936-318-100	5.20



#### L-Halterung

Stahl

Variante	Art.-Nr.	CHF
	290-016-00	4.20





## Linea 20 | Profil-System

elegant und funktional als System

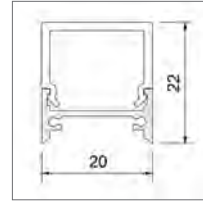

20 x 22 mm

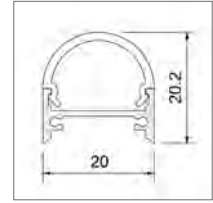

20 x 20.2 mm

### Anwendungsbeispiele

- Architekturbeleuchtung
- Badezimmer
- Küchen
- Treppenhäuser und Flure
- Bars und Restaurants
- Möbelbeleuchtung
- Regalbeleuchtung
- Spiegelbeleuchtung
- Unterschrankbeleuchtung

### Informationen

- Touch-Dimmer integrierbar (nur mit rundem Diffusor)
- rückseitige Kabelführung möglich
- für Akzentbeleuchtung
- nicht sichtbare Befestigungsklammern

### Profile



#### H-Profil

Aluminium, eloxiert

Länge	Art.-Nr.	CHF
2000 mm	359-210-012	32.00/m
3000 mm	359-210-013	32.00/m

### Diffusoren



#### Diffusor, eckig

PMMA, opal

Länge	Art.-Nr.	CHF
2000 mm	411-210-062	30.50/m
3000 mm	411-210-063	30.50/m



#### Diffusor, rund

PMMA, opal

Länge	Art.-Nr.	CHF
3000 mm	411-210-065	30.50/m

### Endkappen



#### Endkappe, für Diffusor eckig

Kunststoff

Variante	Art.-Nr.	CHF
	960-210-000	4.20



#### Endkappe, für Diffusor rund

Kunststoff

Variante	Art.-Nr.	CHF
	960-210-002	4.20

## Linea 20 | Profil-System

### Zubehör



#### Profilverbinder

Aluminium, inkl. Schrauben

Variante	Art.-Nr.	CHF
	359-210-025	18.70



#### Eckverbinder

inkl. Diffusor eckig und Profilverbinder,  
200 x 200 mm

Variante	Art.-Nr.	CHF
	UD-359-210-299	• 89.00



#### L-Halterung

Stahl

Variante	Art.-Nr.	CHF
	290-016-00	4.20

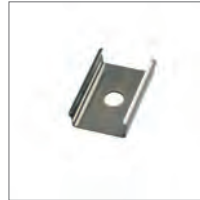

#### Befestigungsklammer

Federstahl, zum Pendeln mit Baldachin oder  
für horizontale/vertikale Befestigung

Variante	Art.-Nr.	CHF
	26491-210-100	5.20



#### Seilabhängung

Ø 1.55 mm, Stromführung im Seil integriert,  
inkl. Deckenbefestiger

Länge	Art.-Nr.	CHF
2500 mm	290-001-01	29.90



#### Baldachin mit LED-Treiber

DALI 2 / PushDim, Stromführung im Seil integriert

Variante	Art.-Nr.	CHF
900 mm, 75 W	161-101-10	394.90
1200 mm, 140 W	161-101-11	427.00

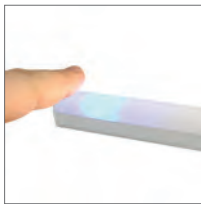

#### Touch-Dimmer

PWM-Dimmung (max. 3A), fertig montiert  
unter Diffusor, mit kapazitiver Taste

Variante	Art.-Nr.	CHF
	UD-210-002-00	• 54.00

## Linea 25 | Profil-System

elegant und funktional als System

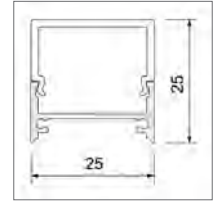
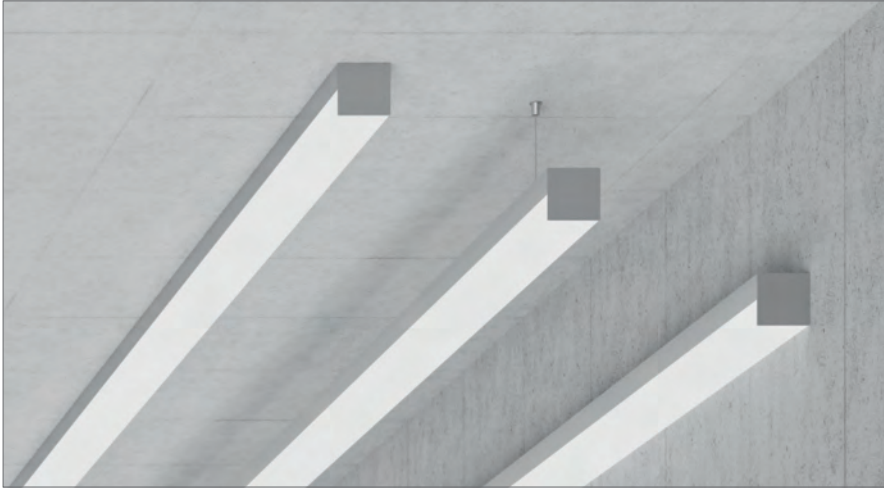

25 x 25 mm

### Anwendungsbeispiele

- Empfang
- Treppenhäuser und Flure
- Bars und Restaurants
- Möbelbeleuchtung

### Informationen

- rückseitige Kabelführung möglich
- nicht sichtbare Befestigungsklammern

### Profile



#### H-Profil

Aluminium, eloxiert

Länge	Art.-Nr.	CHF
3000 mm	100-008-013	33.00/m

### Diffusoren



#### Diffusor

PMMA, opal

Länge	Art.-Nr.	CHF
3000 mm	100-008-063	32.60/m

### Endkappen



#### Endkappe

Aluminium, inkl. Schrauben

Variante	Art.-Nr.	CHF
	100-008-000	5.20

### Zubehör



#### Profilverbinder

Aluminium, inkl. Schrauben

Variante	Art.-Nr.	CHF
	100-008-025	18.70



#### Eckverbinder

inkl. Diffusor und Profilverbinder,  
200 x 200 mm

Variante	Art.-Nr.	CHF
	UD-100-008-999	• 94.00



#### Befestigungsklammer

Federstahl, für horizontale oder vertikale  
Befestigung

Variante	Art.-Nr.	CHF
	100-008-100	6.30



#### L-Halterung

Stahl

Variante	Art.-Nr.	CHF
	290-018-00	6.30

## Linea 25 | Profil-System

### Zubehör



#### Befestigungselement

in Kombination mit Seilabhängung verwenden, geeignet auch für schräge Montage

Variante	Art.-Nr.	CHF
	100-008-200	6.30



#### Seilabhängung

Ø 1.55 mm, Stromführung im Seil integriert, inkl. Deckenbefestiger

Länge	Art.-Nr.	CHF
2500 mm	290-001-01	29.90



#### Baldachin mit LED-Treiber

DALI 2 / PushDim, Stromführung im Seil integriert

Variante	Art.-Nr.	CHF
900 mm, 75 W	161-101-10	394.90
1200 mm, 140 W	161-101-11	427.00





## Linea 25 High | Profil-System

Diffusor pur und funktional als System

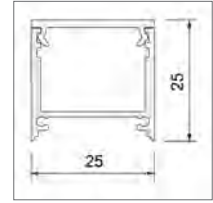

25 x 25 mm

### Anwendungsbeispiele

- Büros
- Empfang
- Treppenhäuser und Flure
- Bars und Restaurants
- Möbelbeleuchtung

### Informationen

- rückseitige Kabelführung möglich
- nicht sichtbare Befestigungsklammern

### Profile



#### H-Profil

Aluminium, eloxiert

Länge	Art.-Nr.	CHF
3000 mm	100-009-013	34.00/m

### Diffusoren



#### Diffusor

PMMA, opal

Länge	Art.-Nr.	CHF
3000 mm	100-009-063	30.50/m

### Endkappen



#### Endkappe

Aluminium, inkl. Schrauben

Variante	Art.-Nr.	CHF
	100-008-000	5.20



#### Endkappe

Kunststoff

Variante	Art.-Nr.	CHF
	100-009-000	5.20

### Zubehör



#### Profilverbinder

Aluminium, inkl. Schrauben

Variante	Art.-Nr.	CHF
	100-008-025	18.70



#### Eckverbinder

inkl. Diffusor und Profilverbinder,  
200 x 200 mm

Variante	Art.-Nr.	CHF
	UD-100-009-999	• 94.00



#### Befestigungsklammer

Federstahl, für horizontale oder vertikale  
Befestigung

Variante	Art.-Nr.	CHF
	100-008-100	6.30



#### L-Halterung

Stahl

Variante	Art.-Nr.	CHF
	290-018-00	6.30

## Linea 25 High | Profil-System

### Zubehör



#### Befestigungselement

in Kombination mit Seilabhängung verwenden, geeignet auch für schräge Montage

Variante	Art.-Nr.	CHF
	100-008-200	6.30



#### Seilabhängung

Ø 1.55 mm, Stromführung im Seil integriert, inkl. Deckenbefestiger

Länge	Art.-Nr.	CHF
2500 mm	290-001-01	29.90



#### Baldachin mit LED-Treiber

DALI 2 / PushDim, Stromführung im Seil integriert

Variante	Art.-Nr.	CHF
900 mm, 75 W	161-101-10	394.90
1200 mm, 140 W	161-101-11	427.00



## Linea 30 II | Profil-System

direkt/indirekt, schlank und systematisch

NEW

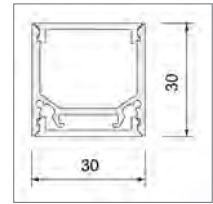
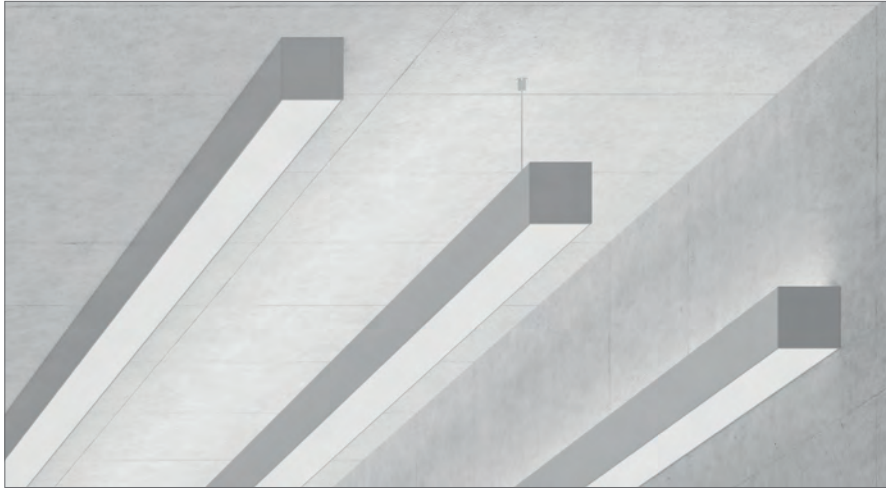

30 x 30 mm

### Anwendungsbeispiele

- Büros
- Empfang
- Treppenhäuser und Flure
- Bars und Restaurants
- Möbelbeleuchtung

### Informationen

- für Direkt-/Indirektbeleuchtung
- rückseitige Kabelführung möglich
- nicht sichtbare Befestigungsklammern

### Profile



#### H-Profil

Aluminium, eloxiert

Länge	Art.-Nr.	CHF
3000 mm	100-014-013	38.40/m

### Diffusoren

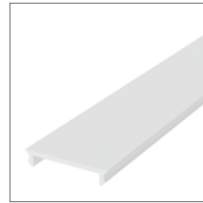

#### Diffusor

PMMA, opal

Länge	Art.-Nr.	CHF
3000 mm	411-330-063	31.50/m

### Endkappen



#### Endkappe

Aluminium

Variante	Art.-Nr.	CHF
	100-014-000	10.50

### Zubehör



#### Profilverbinder

Aluminium, inkl. Schrauben

Variante	Art.-Nr.	CHF
	100-014-025	18.70



#### Eckverbinder

inkl. Diffusor und Profilverbinder,  
200 x 200 mm

Variante	Art.-Nr.	CHF
	UD-100-014-999	• 99.00



#### Befestigungsklammer

Federstahl, zum Pendeln mit Baldachin oder  
für horizontale/vertikale Befestigung

Variante	Art.-Nr.	CHF
	100-014-100	6.30



#### L-Halterung

Stahl

Variante	Art.-Nr.	CHF
	290-019-00	8.50



## Linea 30 II | Profil-System

### Zubehör



#### Seilabhängung

Ø 1.55 mm, Stromführung im Seil integriert,  
inkl. Deckenbefestiger

Länge	Art.-Nr.	CHF
2500 mm	290-001-01	29.90



#### Baldachin mit LED-Treiber

DALI 2 / PushDim, Stromführung im Seil integriert

Variante	Art.-Nr.	CHF
900 mm, 75 W	161-101-10	394.90
1200 mm, 140 W	161-101-11	427.00



## Basic 30 | Profil-System

Klassisch gut

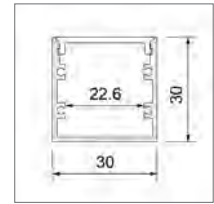

30 x 30 mm

### Anwendungsbeispiele

- Büros
- Empfang
- Treppenhäuser und Flure
- Bars und Restaurants

- Möbelbeleuchtung

### Informationen

- Einbetonierhilfe erhältlich

### Profile



#### U-Profil

Aluminium, eloxiert

Länge	Art.-Nr.	CHF
3000 mm	359-330-013	33.00/m

### Diffusoren



#### Diffusor

PMMA, opal

Länge	Art.-Nr.	CHF
3000 mm	411-330-063	29.50/m

### Endkappen



#### Endkappe

Aluminium

Variante	Art.-Nr.	CHF
	960-330-000	9.80

### Zubehör



#### Einbetonierhilfe

Kunststoff, BxH: 32 x 32 mm, für Putzdecke

Länge	Art.-Nr.	CHF
3000 mm	960-330-203	104.70



#### L-Halterung

Stahl

Variante	Art.-Nr.	CHF
	290-019-00	8.50





## Duplex | Profil-System

Aufbau- und Pendelleuchte mit System und Kabelführung

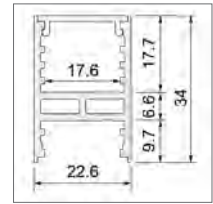

22.6 x 34 mm

### Anwendungsbeispiele

- Bars und Restaurants
- Essbereich
- Küchen
- Empfang

### Informationen

- rückseitige Kabelführung möglich
- für Direkt-/Indirektbeleuchtung
- nicht sichtbare Befestigungsklammern

### Profile



#### H-Profil

Aluminium, eloxiert

Länge	Art.-Nr.	CHF
3000 mm	100-226-013	38.40/m

### Diffusoren

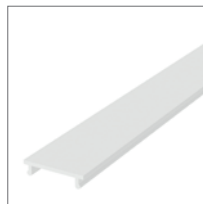

#### Diffusor

PMMA, opal

Länge	Art.-Nr.	CHF
3000 mm	100-226-063	26.20/m

### Endkappen



#### Endkappe

Aluminium

Variante	Art.-Nr.	CHF
	100-226-000	9.50

### Zubehör



#### Profilverbinder

Aluminium, inkl. Schrauben

Variante	Art.-Nr.	CHF
	100-226-025	16.00



#### Eckverbinder

inkl. Diffusor und Profilverbinder,  
200 x 200 mm

Variante	Art.-Nr.	CHF
	UD-100-226-999	• 99.00



#### Befestigungsklammer

Federstahl

Variante	Art.-Nr.	CHF
	100-226-100	5.20



#### L-Halterung

Stahl

Variante	Art.-Nr.	CHF
	290-019-00	8.50



## Duplex | Profil-System

### Zubehör



#### Befestigungselement

in Kombination mit Seilabhängung verwenden, geeignet auch für schräge Montage

Variante	Art.-Nr.	CHF
	100-226-200	8.50



#### Seilabhängung

Ø 1.55 mm, Stromführung im Seil integriert, inkl. Deckenbefestiger

Länge	Art.-Nr.	CHF
2500 mm	290-001-01	29.90



#### Baldachin mit LED-Treiber

DALI 2 / PushDim, Stromführung im Seil integriert

Variante	Art.-Nr.	CHF
900 mm, 75 W	161-101-10	394.90
1200 mm, 140 W	161-101-11	427.00

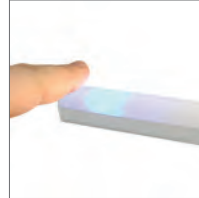

#### Touch-Dimmer

PWM-Dimmung (max. 3A), fertig montiert unter Diffusor, mit kapazitiver Taste

Variante	Art.-Nr.	CHF
	UD-210-002-00	• 54.00



## Basic 35 | Profil-System

Top integriert in die Architektur

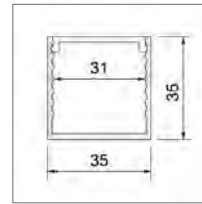

35 x 35 mm

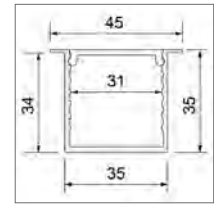

35 x 35 mm,  
mit Kragen

### Anwendungsbeispiele

- Architekturbeleuchtung
- Treppenhäuser und Flure
- Bars und Restaurants

### Informationen

- für Einbau in Hohldecken (Holz, Gips)
- Einbetonierhilfe erhältlich
- für LED-Band und -Platine

### Profile

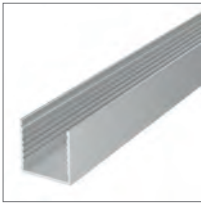

#### U-Profil

Aluminium, eloxiert

Länge	Art.-Nr.	CHF
2000 mm	359-350-012	33.00/m
3000 mm	359-350-013	33.00/m
4000 mm	359-350-014	33.00/m

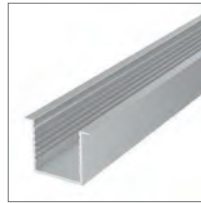

#### U-Profil mit Kragen

Aluminium, eloxiert

Länge	Art.-Nr.	CHF
3000 mm	359-350-023	33.00/m
4000 mm	359-350-024	33.00/m

### Diffusoren



#### Diffusor

PMMA, opal

Länge	Art.-Nr.	CHF
2000 mm	411-350-062	31.50/m
3000 mm	411-350-063	31.50/m
4000 mm	411-350-064	31.50/m



#### Diffusor

PMMA, schwarz/opal

Länge	Art.-Nr.	CHF
4000 mm	411-350-074	36.90/m

### Endkappen



#### Endkappe

Kunststoff

Variante	Art.-Nr.	CHF
	960-350-000	5.20



#### Endkappe, für U-Profil mit Kragen

Kunststoff

Variante	Art.-Nr.	CHF
	960-350-001	5.20

### Zubehör



#### L-Halterung

Stahl

Variante	Art.-Nr.	CHF
	290-018-00	6.30



#### Einbetonierhilfe

Kunststoff, BxH: 38 x 38 mm, für Putzdecke, leicht konisch für eine einfachere und schnellere Ausschalung

Länge	Art.-Nr.	CHF
4000 mm	960-350-214	170.80







## Modular 18 | Profil-System

Die reine Pendellösung

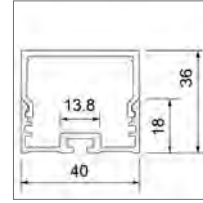

40 x 36 mm



40 x 48 mm

### Anwendungsbeispiele

- Empfang
- Treppenhäuser und Flure
- Bars und Restaurants
- Essbereich

### Profile

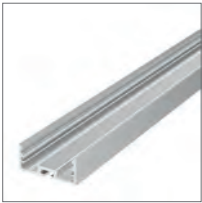

#### U-Profil

Aluminium, eloxiert

Länge	Art.-Nr.	CHF
4000 mm	936-040-034	36.30/m

### Diffusoren



#### Diffusor, 18

PMMA, opal

Länge	Art.-Nr.	CHF
4000 mm	936-040-075	39.50/m



#### Diffusor, 30

PMMA, opal

Länge	Art.-Nr.	CHF
4000 mm	936-040-074	39.50/m

### Endkappen



#### Endkappe, für Diffusor 18

Aluminium

Variante	Art.-Nr.	CHF
	6682-040-125	18.00



#### Endkappe, für Diffusor 30

Aluminium

Variante	Art.-Nr.	CHF
	6682-040-126	19.00

### Zubehör



#### L-Halterung

Stahl

Variante	Art.-Nr.	CHF
	290-019-00	8.50



#### Seilabhängung

Ø 1.0 mm

Länge	Art.-Nr.	CHF
2000 mm	290-002-00	15.90









## Modular 42 | Profil-System

Das komplette System in Form und Installationsvielfalt

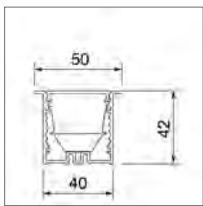

40 x 42, mit Kragen

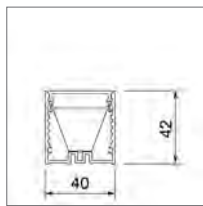

40 x 42 mm

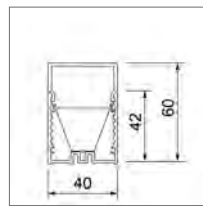

40 x 60 mm

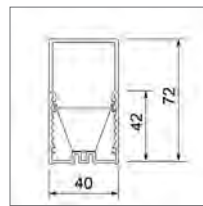

40 x 72 mm

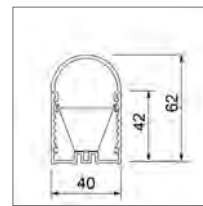

40 x 62 mm

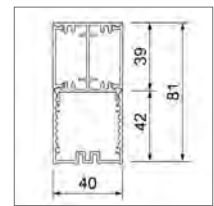

40 x 81 mm

### Anwendungsbeispiele

- Büros
- Empfang
- Treppenhäuser und Flure
- Bars und Restaurants
- Spiegelbeleuchtung

### Informationen

- modulares System
- LED-Treiber in Profil integrierbar
- für direkte/indirekte Wandbeleuchtung
- für Einbau in Hohldecken (Holz, Gips)
- für LED-Band und -Platine
- Durchgangsverdrahtung für schnelle Montage
- Einbetonierhilfe erhältlich
- Notlichtelement in Profil integrierbar

### Profile



#### U-Profil

Aluminium, eloxiert

Länge	Art.-Nr.	CHF
4000 mm	936-040-014	41.60/m
5000 mm	936-040-015	41.60/m



#### U-Profil

Aluminium, weiss, ~RAL 9003, pulverbeschichtet

Länge	Art.-Nr.	CHF
5000 mm	936-040-215	54.50/m



#### U-Profil mit Kragen

Aluminium, eloxiert

Länge	Art.-Nr.	CHF
4000 mm	936-040-004	41.60/m



#### H-Profil

Aluminium, eloxiert

Variante	Art.-Nr.	CHF
4000 mm	936-040-094	41.60/m



## Modular 42 | Profil-System

### Diffusoren und Abdeckungen



#### Abdeckung

Aluminium, eloxiert

Länge	Art.-Nr.	CHF
4000 mm	936-040-095	22.40/m



#### Diffusor

PMMA, satiniert

Länge	Art.-Nr.	CHF
4000 mm	936-040-055	32.00/m



#### Diffusor

PMMA, opal

Länge	Art.-Nr.	CHF
4000 mm	936-040-065	32.00/m



#### Diffusor, gerollt

PMMA, opal, 15 m kontinuierliche Lichtlinie ohne Unterbruch

Länge	Art.-Nr.	CHF
15000 mm	936-040-068	42.70/m

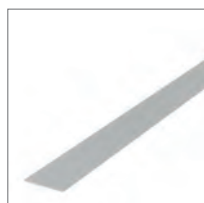

#### Mikroprismatische Optik

UGR <22 (mit Diffusor satiniert und max. 24 W/m LED-Band)

Länge	Art.-Nr.	CHF
1500 mm	936-040-053	41.70/m



#### Diffusor, mikroprismatisch, gerollt

PMMA, 15 m kontinuierliche Lichtlinie ohne Unterbruch, UGR <25 (bei max. 24 W/m LED-Band)

Länge	Art.-Nr.	CHF
15000 mm	936-040-050	53.40/m



#### Diffusor, 18

PMMA, opal

Länge	Art.-Nr.	CHF
4000 mm	936-040-075	39.50/m
5000 mm	936-040-078	39.50/m



#### Diffusor, 30

PMMA, opal

Länge	Art.-Nr.	CHF
4000 mm	936-040-074	39.50/m
5000 mm	936-040-077	39.50/m



#### Diffusor, rund

PMMA, opal

Länge	Art.-Nr.	CHF
4000 mm	936-040-076	39.50/m



15 m fugenlos  
dank rollbaren  
Diffusor

## Modular 42 | Profil-System

### Endkappen



#### Endkappe

Aluminium, eloxiert

Farbe	Art.-Nr.	CHF
silber	6682-040-120	19.00
weiss	6682-040-132	23.30



#### Endkappe, für U-Profil mit Kragen

Aluminium, eloxiert

Variante	Art.-Nr.	CHF
	6682-040-128	19.00



#### Endkappe, für Diffusor 18

Aluminium, eloxiert

Farbe	Art.-Nr.	CHF
silber	6682-040-123	21.20
weiss	6682-040-131	24.40



#### Endkappe, für Diffusor 30

Aluminium, eloxiert

Farbe	Art.-Nr.	CHF
silber	6682-040-122	21.20
weiss	6682-040-130	24.40



#### Endkappe, für Diffusor 30 und U-Profil mit Kragen

Aluminium, eloxiert

Variante	Art.-Nr.	CHF
	6682-040-129	21.20



#### Endkappe, für Diffusor rund

Aluminium, eloxiert

Farbe	Art.-Nr.	CHF
silber	6682-040-127	21.20
weiss	6682-040-133	24.40



#### Endkappe, für Kombination H- und U-Profil

Aluminium, eloxiert

Variante	Art.-Nr.	CHF
	6682-040-121	21.20



## Modular 42 | Profil-System

### Zubehör



#### Profilverbinder

Stahl, inkl. Schrauben

Länge	Art.-Nr.	CHF
80 mm	936-040-002	10.60



#### Profilverbinder

Stahl, inkl. Schrauben

Länge	Art.-Nr.	CHF
200 mm	936-040-012	18.00



#### Eckverbinder

inkl. Diffusor opal und Profilverbinder,  
200 x 200 mm

Variante	Art.-Nr.	CHF
	UD-101-002-999	• 104.00



#### Eckverbinder, mit Kragen

inkl. Diffusor opal und Profilverbinder,  
200 x 200 mm

Variante	Art.-Nr.	CHF
	UD-101-001-999	• 104.00



#### Trägerschiene

Aluminium, eloxiert

Länge	Art.-Nr.	CHF
2000 mm	4401-040-084	10.60/m
2500 mm	4401-040-085	10.60/m



#### Befestigungsklammer

Variante	Art.-Nr.	CHF
	26491-040-085	7.40



#### Befestigungsklammer, niedrig

Federstahl

Variante	Art.-Nr.	CHF
	26491-040-080	6.30



#### Hohldecken-Einbauhalterung

Variante	Art.-Nr.	CHF
	26491-040-075	10.60



#### Einbetonierhilfe

Kunststoff, BxH: 43 x 44 mm, für Putzdecke

Länge	Art.-Nr.	CHF
4000 mm	960-040-204	192.00



#### L-Halterung

Stahl

Variante	Art.-Nr.	CHF
	290-019-00	8.50



#### Befestigungselement

Verstellbereich Pendelpunkt: 10 cm,  
LxBxH: 130 x 14 x 6.2 mm

Variante	Art.-Nr.	CHF
	290-020-00	9.50



#### Seilabhängung

Ø 1.55 mm, Stromführung im Seil integriert,  
inkl. Deckenbefestiger

Länge	Art.-Nr.	CHF
2500 mm	290-001-01	29.90



#### Baldachin mit LED-Treiber

DALI 2 / PushDim, Stromführung im Seil integriert

Variante	Art.-Nr.	CHF
900 mm, 75 W	161-101-10	394.90
1200 mm, 140 W	161-101-11	427.00



#### Notlichtelement

vollautomatischer Selbsttest, 3 h, fertig in  
Profil montiert

Variante	Art.-Nr.	CHF
	UD-211-002-200	• 299.00

## Modular 60 | Profil-System

Technik und Lichttechnik Integriert

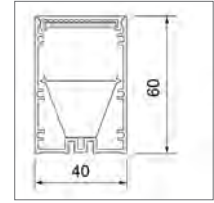

40 x 60 mm

### Anwendungsbeispiele

- Büros
- Empfang
- Schulen/Kindergarten
- Bars und Restaurants
- Treppenhäuser und Flure

### Informationen

- modulares System
- LED-Treiber in Profil integrierbar
- UGR <22 möglich
- für LED-Band und -Platine
- Durchgangsverdrahtung für schnelle Montage
- Notlichtelement in Profil integrierbar

### Profile



#### U-Profil

Aluminium, eloxiert

Länge	Art.-Nr.	CHF
4000 mm	936-040-044	50.00/m

### Diffusoren



#### Diffusor

PMMA, satiniert

Länge	Art.-Nr.	CHF
4000 mm	936-040-055	32.00/m



#### Diffusor

PMMA, opal

Länge	Art.-Nr.	CHF
4000 mm	936-040-065	32.00/m



#### Diffusor, gerollt

PMMA, opal, 15 m kontinuierliche Lichtlinie ohne Unterbruch

Länge	Art.-Nr.	CHF
15000 mm	936-040-068	42.70/m

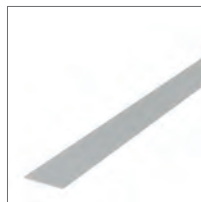

#### Mikroprismatische Optik

UGR <22 (mit Diffusor satiniert und max. 24 W/m LED-Band)

Länge	Art.-Nr.	CHF
1500 mm	936-040-053	41.70/m



#### Diffusor, mikroprismatisch, gerollt

PMMA, 15 m kontinuierliche Lichtlinie ohne Unterbruch, UGR <25 (bei max. 24 W/m LED-Band)

Länge	Art.-Nr.	CHF
15000 mm	936-040-050	53.40/m

## Modular 60 | Profil-System

### Endkappen



#### Endkappe

Aluminium

Variante	Art.-Nr.	CHF
	6682-040-124	21.20

### Zubehör



#### Profilverbinder

Stahl, inkl. Schrauben

Länge	Art.-Nr.	CHF
80 mm	936-040-002	10.60



#### Profilverbinder

Stahl, inkl. Schrauben

Länge	Art.-Nr.	CHF
200 mm	936-040-012	18.00



#### Eckverbinder

inkl. Diffusor opal und Profilverbinder,  
200 x 200 mm

Variante	Art.-Nr.	CHF
	UD-101-003-999	109.00



#### Trägerschiene

Aluminium, eloxiert

Länge	Art.-Nr.	CHF
2000 mm	4401-040-084	10.60/m
2500 mm	4401-040-085	10.60/m



#### Befestigungsklammer

Variante	Art.-Nr.	CHF
	26491-040-085	7.40



#### L-Halterung

Stahl

Variante	Art.-Nr.	CHF
	290-019-00	8.50



#### Befestigungselement

Verstellbereich Pendelpunkt: 10 cm,  
LxBxH: 130 x 14 x 6.2 mm

Variante	Art.-Nr.	CHF
	290-020-00	9.50



#### Seilabhängung

Ø 1.55 mm, Stromführung im Seil integriert,  
inkl. Deckenbefestiger

Länge	Art.-Nr.	CHF
2500 mm	290-001-01	29.90



#### Baldachin mit LED-Treiber

DALI 2 / PushDim, Stromführung im Seil  
integriert

Variante	Art.-Nr.	CHF
900 mm, 75 W	161-101-10	394.90
1200 mm, 140 W	161-101-11	427.00



#### Notlichtelement

vollautomatischer Selbsttest, 3 h, fertig in  
Profil montiert

Variante	Art.-Nr.	CHF
	UD-211-002-200	299.00



15 m fugenlos  
dank rollbaren  
Diffusor



## Tek 1 | Profil-System

volle Leistung integriert

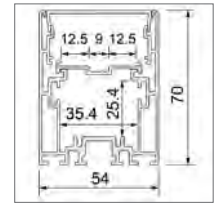
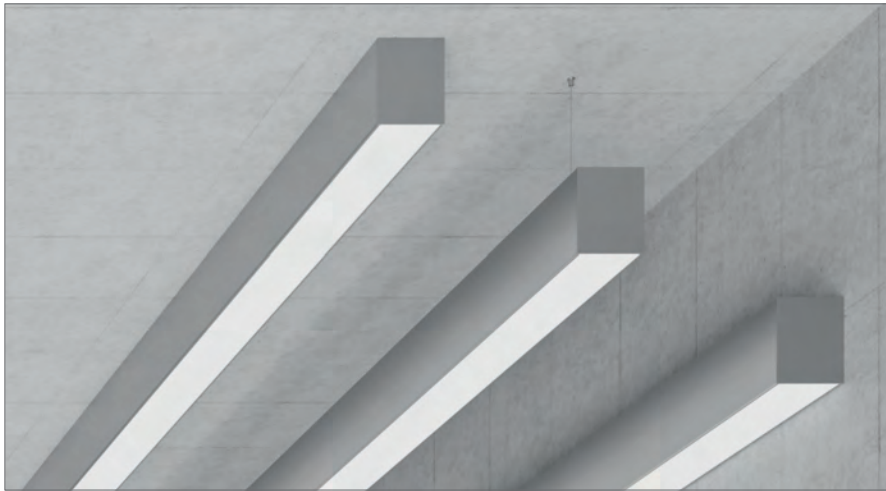

54 x 70 mm

### Anwendungsbeispiele

- Büros
- Schulen/Kindergarten
- Empfang
- Treppenhäuser und Flure

### Informationen

- LED-Treiber in Profil integrierbar
- mit 2 LED-Bänder zu bestücken

### Profile



#### U-Profil

Aluminium, eloxiert, inkl. Trägerschiene

Länge	Art.-Nr.	CHF
2500 mm	100-001-012	74.50/m

### Diffusoren

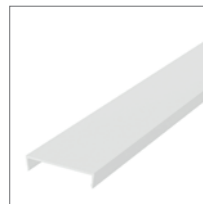

#### Diffusor

Polycarbonat, opal

Länge	Art.-Nr.	CHF
2500 mm	100-001-062	31.50/m

### Endkappen



#### Endkappe

Kunststoff, mit Magnetverschluss

Variante	Art.-Nr.	CHF
	100-001-000	10.60

### Zubehör



#### Befestigungselement

Set à 2 Stk., für Trägerschiene

Variante	Art.-Nr.	CHF
	100-001-004	16.90



#### Seilabhängung

Ø 1.5 mm

Länge	Art.-Nr.	CHF
2000 mm	100-001-003	16.00



#### L-Halterung

Variante	Art.-Nr.	CHF
	100-001-005	8.50



#### Profilverbinder

Set à 4 Stk., inkl. Madenschrauben

Variante	Art.-Nr.	CHF
	100-001-002	5.20

## Tek 2 | Profil-System

volle Leistung in der Hohldecke

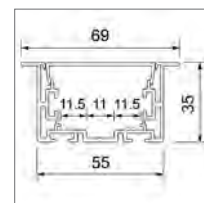
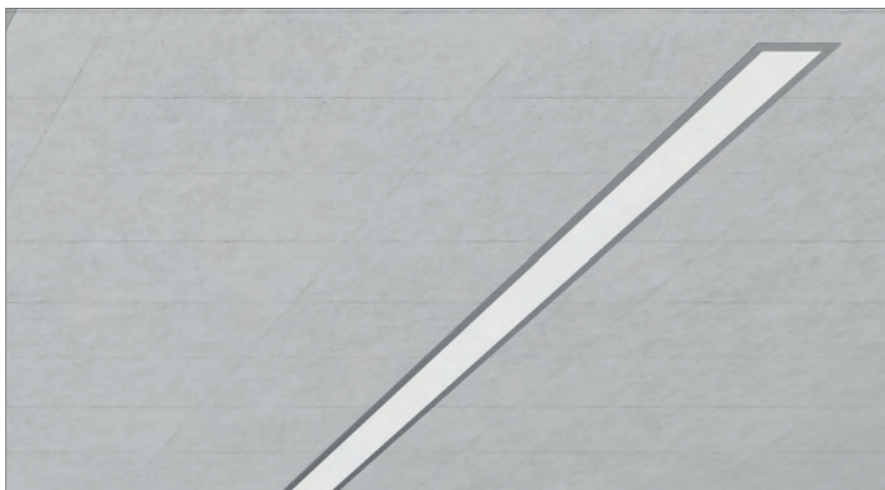

55 x 35 mm,  
mit Kragen

### Anwendungsbeispiele

- Büros
- Schulen/Kindergarten
- Empfang
- Treppenhäuser und Flure

### Informationen

- für Einbau in Hohldecken (Holz, Gips)
- mit 2 LED-Bänder zu bestücken

### Profile



#### U-Profil mit Kragen

Aluminium, eloxiert

Länge	Art.-Nr.	CHF
2500 mm	100-002-012	52.90/m

### Diffusoren

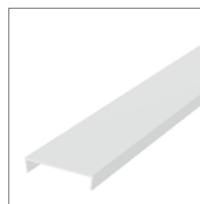

#### Diffusor

Polycarbonat, opal

Länge	Art.-Nr.	CHF
2500 mm	100-001-062	31.50/m

### Endkappen



#### Endkappe

Kunststoff, mit Magnetverschluss

Variante	Art.-Nr.	CHF
	100-002-000	10.60

### Zubehör



#### Hohldecken-Einbauhalterung

Set à 2 Stk.

Variante	Art.-Nr.	CHF
	100-002-001	16.90



#### Profilverbinder

Set à 4 Stk., inkl. Madenschrauben

Variante	Art.-Nr.	CHF
	100-002-002	5.20

## Edge | Profil-System

aus der Ecke

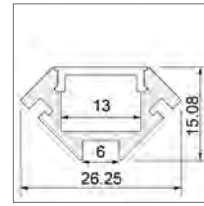

45°

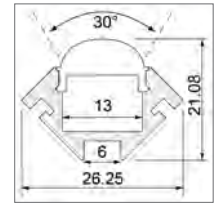

45°

### Anwendungsbeispiele

- Architekturbeleuchtung
- Küchen
- Vitrinen
- Möbelbeleuchtung
- Treppenstufen und Handläufe

### Informationen

- auch mit 30° Optik - ideal für Wandbeleuchtung
- für Eckenbeleuchtung

### Profile



#### Eckprofil

Aluminium, eloxiert

Länge	Art.-Nr.	CHF
3000 mm	359-045-013	36.30/m

### Diffusoren

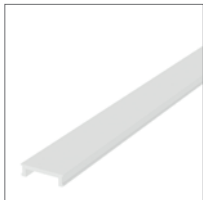

#### Diffusor

Polycarbonat, opal

Länge	Art.-Nr.	CHF
2000 mm	411-175-062	24.00/m
3000 mm	411-175-163	26.20/m



#### Diffusor

PMMA, 10% satiniert, 30°

Länge	Art.-Nr.	CHF
3000 mm	411-175-083	36.90/m

### Endkappen

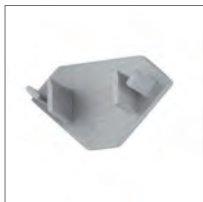

#### Endkappe

Kunststoff

Variante	Art.-Nr.	CHF
	960-045-000	4.20

### Zubehör



#### Befestigungsklammer

Kunststoff, für horizontale Befestigung

Variante	Art.-Nr.	CHF
	960-045-100	5.20



#### Befestigungsklammer

Federstahl, für horizontale oder vertikale Befestigung

Variante	Art.-Nr.	CHF
	26491-045-100	8.50





## Corner 16 | Profil-System

sichtbares Licht aus der Ecke

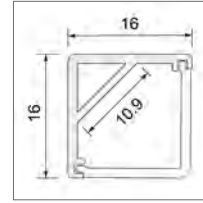
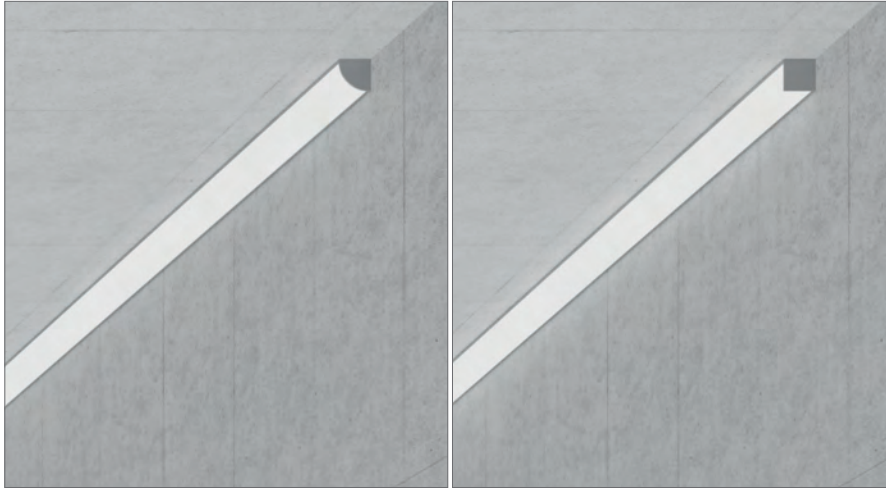

16 x 16 mm

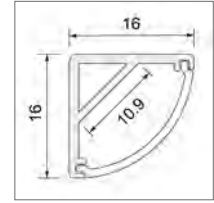

16 x 16 mm

### Anwendungsbeispiele

- Architekturbeleuchtung
- Küchen
- Vitrinen
- Möbelbeleuchtung
- Treppenstufen und Handläufe

### Informationen

- für Eckenbeleuchtung
- für Indirektbeleuchtung

### Profile



#### Eckprofil

Aluminium, eloxiert

Länge	Art.-Nr.	CHF
3000 mm	100-005-013	27.70/m

### Diffusoren

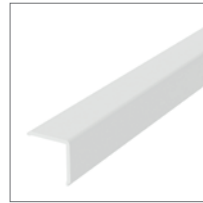

#### Diffusor, eckig

Polycarbonat, opal

Länge	Art.-Nr.	CHF
3000 mm	100-005-063	26.20/m

### Diffusoren



#### Diffusor, rund

Polycarbonat, satiniert

Länge	Art.-Nr.	CHF
3000 mm	100-005-052	26.20/m

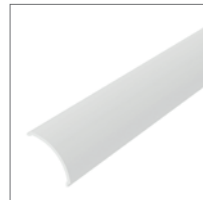

#### Diffusor, rund

Polycarbonat, opal

Länge	Art.-Nr.	CHF
3000 mm	100-005-062	26.20/m

### Endkappen



#### Endkappe, für Diffusor eckig

Kunststoff

Variante	Art.-Nr.	CHF
	100-005-002	4.20



#### Endkappe, für Diffusor rund

Kunststoff

Variante	Art.-Nr.	CHF
	100-005-000	4.20

### Zubehör



#### Befestigungsklammer

Federstahl, für horizontale oder vertikale Befestigung

Variante	Art.-Nr.	CHF
	100-005-100	4.20

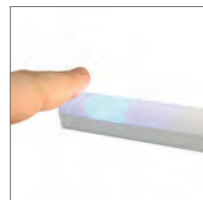

#### Touch-Dimmer

PWM-Dimmung (max. 3A), fertig montiert unter Diffusor, mit kapazitiver Taste

Variante	Art.-Nr.	CHF
	UD-210-002-00	• 54.00







## Corner 30 | Profil-System

sichtbares Licht aus der Ecke

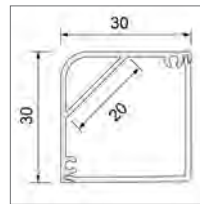
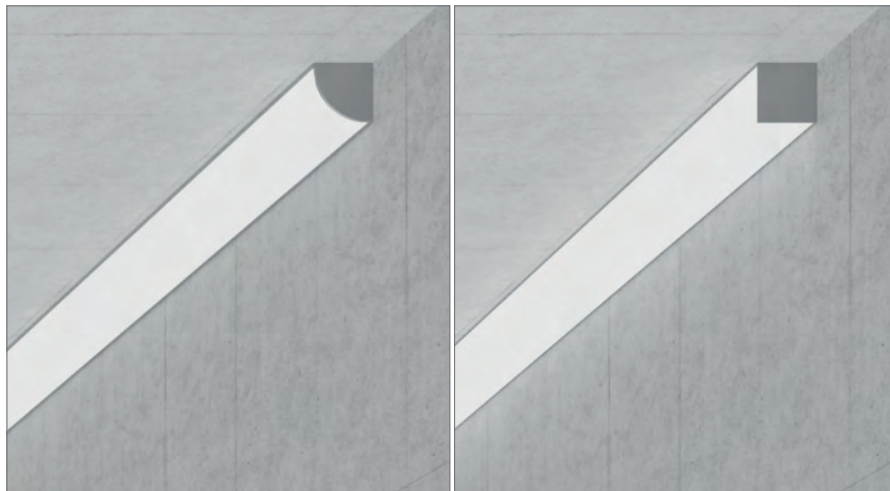

30 x 30 mm

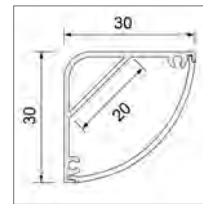

30 x 30 mm

### Anwendungsbeispiele

- Bars und Restaurants
- Möbelbeleuchtung
- Regalbeleuchtung
- Unterschrankbeleuchtung

### Informationen

- rückseitige Kabelführung möglich
- für Eckenbeleuchtung

### Profile



#### Eckprofil

Aluminium, eloxiert

Länge	Art.-Nr.	CHF
3000 mm	100-006-013	38.40/m

### Diffusoren

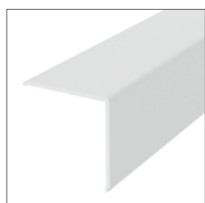

#### Diffusor, eckig

Polycarbonat, opal

Länge	Art.-Nr.	CHF
3000 mm	100-006-063	31.50/m

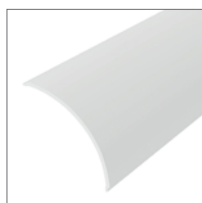

#### Diffusor, rund

Polycarbonat, opal

Länge	Art.-Nr.	CHF
3000 mm	100-006-062	31.50/m

### Endkappen



#### Endkappe, für Diffusor eckig

Kunststoff

Variante	Art.-Nr.	CHF
	100-006-002	5.20



#### Endkappe, für Diffusor rund

Kunststoff

Variante	Art.-Nr.	CHF
	100-006-000	5.20

### Zubehör



#### Befestigungsklammer

Federstahl, für horizontale oder vertikale Befestigung

Variante	Art.-Nr.	CHF
	100-006-100	5.20



## Tube 16 | Profil-System

filigrane Schönheit

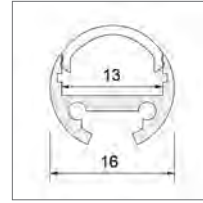

Ø 16 mm

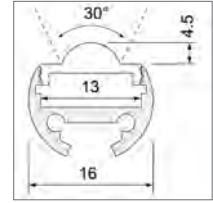

Ø 16 mm

### Anwendungsbeispiele

- Architekturbeleuchtung
- Möbelbeleuchtung

### Informationen

- auch mit 30° Optik - ideal für Wandbeleuchtung
- für Akzentbeleuchtung

### Profile



#### Rundprofil

Aluminium, eloxiert

Länge	Art.-Nr.	CHF
3000 mm	936-016-013	27.70/m

### Diffusoren



#### Diffusor

PMMA, opal

Länge	Art.-Nr.	CHF
3000 mm	936-016-063	26.20/m



#### Diffusor

PMMA, satiniert, 30°

Länge	Art.-Nr.	CHF
3000 mm	936-016-083	36.90/m

### Endkappen

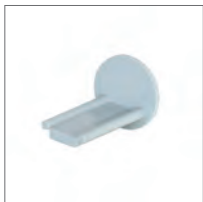

#### Endkappe

Kunststoff

Variante	Art.-Nr.	CHF
	936-016-000	4.20

### Zubehör



#### Befestigungsklammer

Kunststoff, für horizontale Befestigung

Variante	Art.-Nr.	CHF
	936-016-100	5.20



#### Befestigungsklammer

Stahl, für horizontale oder vertikale Befestigung

Variante	Art.-Nr.	CHF
	936-016-110	5.20



## Tube 16 | Profil-System

### Zubehör



#### L-Halterung

Stahl

Variante	Art.-Nr.	CHF
	290-016-00	4.20

## Tube 26 | Profil-System

genau richtig proportioniert

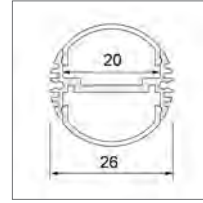
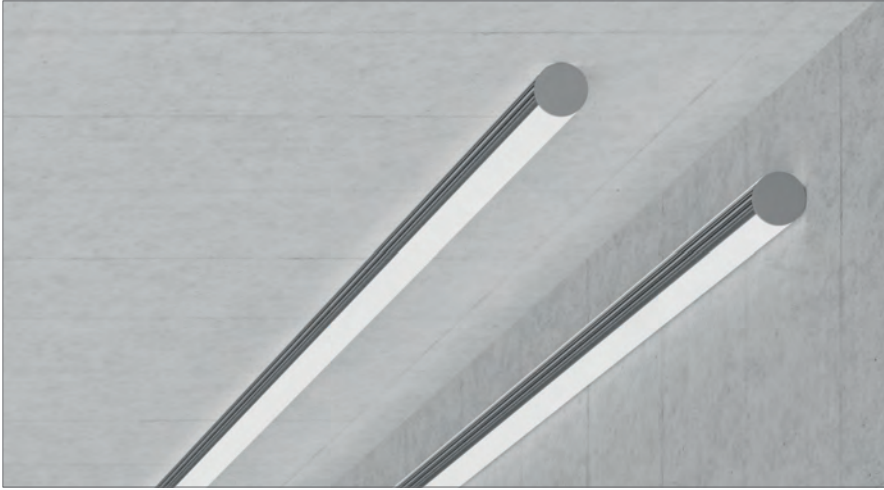

Ø 26 mm

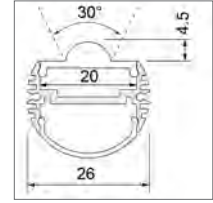

Ø 26 mm

### Anwendungsbeispiele

- Architekturbeleuchtung
- Küchen
- Möbelbeleuchtung

### Informationen

- auch mit 30° Optik - ideal für Wandbeleuchtung
- für Akzentbeleuchtung

### Profile



#### Rundprofil

Aluminium, eloxiert

Länge	Art.-Nr.	CHF
3000 mm	936-026-013	33.00/m

### Diffusoren und Abdeckungen

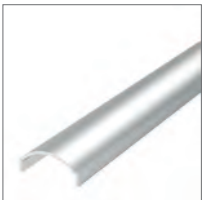

#### Abdeckung

Aluminium

Länge	Art.-Nr.	CHF
3000 mm	936-026-033	10.60/m



#### Diffusor

PMMA, satiniert

Länge	Art.-Nr.	CHF
3000 mm	936-026-053	26.20/m



#### Diffusor

PMMA, opal

Länge	Art.-Nr.	CHF
3000 mm	936-026-063	26.20/m



#### Diffusor

PMMA, satiniert, 30°

Länge	Art.-Nr.	CHF
3000 mm	936-026-083	36.90/m

### Endkappen



#### Endkappe

Kunststoff, inkl. Schrauben

Variante	Art.-Nr.	CHF
	936-026-000	5.20

## Tube 26 | Profil-System

### Zubehör



#### Befestigungsklammer

Stahl, für horizontale oder vertikale Befestigung

Variante	Art.-Nr.	CHF
	936-026-110	5.20



#### L-Halterung

Stahl

Variante	Art.-Nr.	CHF
	290-019-00	8.50

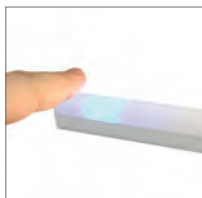

#### Touch-Dimmer

PWM-Dimmung (max. 3A), fertig montiert unter Diffusor, mit kapazitiver Taste

Variante	Art.-Nr.	CHF
	UD-210-002-00	• 54.00



## Tube 35 | Profil-System

Das schlanke Lichtschwert

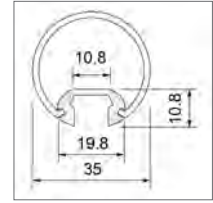

Ø 35 mm

### Anwendungsbeispiele

- Architekturbeleuchtung
- Bars und Restaurants
- Möbelbeleuchtung
- Spiegelbeleuchtung
- Treppenstufen und Handläufe

### Informationen

- nicht sichtbare Befestigungsklammern

### Profile



#### Rundprofil

Aluminium, eloxiert

Länge	Art.-Nr.	CHF
3000 mm	100-007-013	30.90/m

### Diffusoren



#### Diffusor

Polycarbonat, opal

Länge	Art.-Nr.	CHF
3000 mm	100-007-063	40.00/m

### Endkappen



#### Endkappe

Kunststoff

Variante	Art.-Nr.	CHF
	100-007-000	5.20

### Zubehör



#### Profilverbinder

Stahl, inkl. Schrauben, nur für Voutenbeleuchtung

Variante	Art.-Nr.	CHF
	100-007-025	9.50

### Zubehör

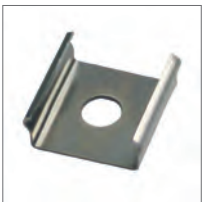

#### Befestigungsklammer

Federstahl, zum Pendeln mit Baldachin oder für horizontale/vertikale Befestigung

Variante	Art.-Nr.	CHF
	100-007-100	5.20



#### L-Halterung

Stahl

Variante	Art.-Nr.	CHF
	290-019-00	8.50



#### Seilabhängung

Ø 1.55 mm, Stromführung im Seil integriert, inkl. Deckenbefestiger

Länge	Art.-Nr.	CHF
2500 mm	290-001-01	29.90



#### Baldachin mit LED-Treiber

DALI 2 / PushDim, Stromführung im Seil integriert

Variante	Art.-Nr.	CHF
900 mm, 75 W	161-101-10	394.90
1200 mm, 140 W	161-101-11	427.00

## Tube 60 | Profil-System

Das Lichtschwert

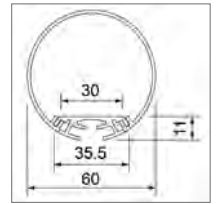
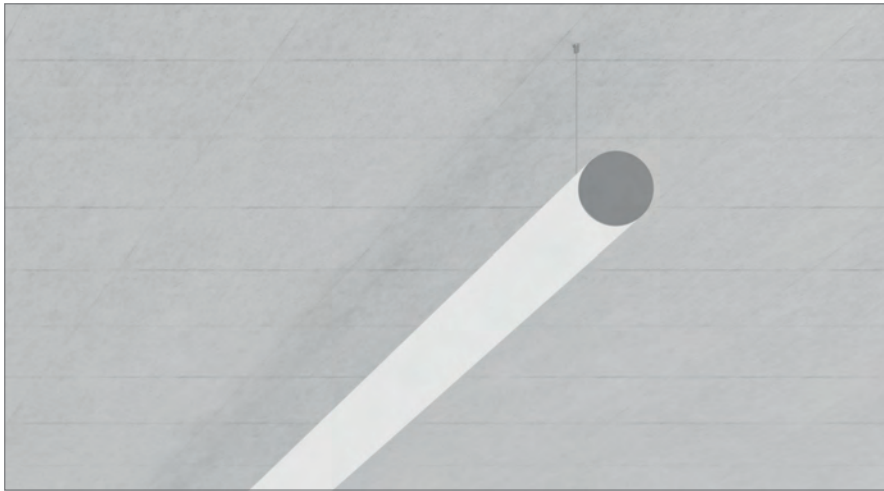

Ø 60 mm

### Anwendungsbeispiele

- Architekturbeleuchtung
- Treppenhäuser und Flure
- Bars und Restaurants
- Empfang

### Informationen

- rückseitige Kabelführung möglich
- für Akzentbeleuchtung

### Profile



#### Rundprofil

Aluminium, eloxiert

Länge	Art.-Nr.	CHF
2500 mm	100-004-012	32.00/m

### Diffusoren



#### Diffusor

Polycarbonat, opal

Länge	Art.-Nr.	CHF
2500 mm	100-004-062	47.50/m

### Endkappen



#### Endkappe

Kunststoff, inkl. Schrauben

Variante	Art.-Nr.	CHF
	100-004-000	5.20

### Zubehör



#### Seilabhängung

Ø 1.5 mm

Länge	Art.-Nr.	CHF
2000 mm	100-004-003	16.00

## Blade Mini | Profil-System

indirekt/direkt in filigranster Form

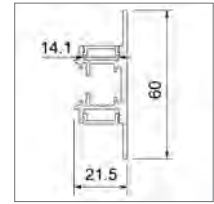

21.5 x 60 mm

### Anwendungsbeispiele

- Architekturbeleuchtung
- Empfang
- Bars und Restaurants

### Informationen

- rückseitige Kabelführung möglich
- für direkte/indirekte Wandbeleuchtung

### Profile



#### Wandprofil

Aluminium, eloxiert

Länge	Art.-Nr.	CHF
3000 mm	100-010-013	42.70/m

### Diffusoren



#### Diffusor

Polycarbonat, opal

Länge	Art.-Nr.	CHF
3000 mm	411-175-163	26.20/m

### Endkappen



#### Endkappe

Aluminium

Variante	Art.-Nr.	CHF
	100-010-000	18.00

### Zubehör



#### Befestigungsklammer

Federstahl, für horizontale oder vertikale Befestigung

Variante	Art.-Nr.	CHF
	100-010-100	5.20



#### Profilverbinder

inkl. Schrauben

Variante	Art.-Nr.	CHF
	100-010-001	10.60



## Blade | Profil-System

indirekt/direkt mit integriertem Treiber

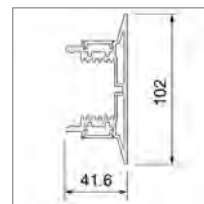

41.6 x 102 mm

### Anwendungsbeispiele

- Architekturbeleuchtung
- Empfang
- Treppenhäuser und Flure
- Bars und Restaurants

### Informationen

- rückseitige Kabelführung möglich
- LED-Treiber in Profil integrierbar
- für direkte/indirekte Wandbeleuchtung
- Notlichtelement in Profil integrierbar

### Profile



#### Wandprofil

Aluminium, eloxiert

Länge	Art.-Nr.	CHF
4000 mm	115-420-014	110.00/m

### Diffusoren

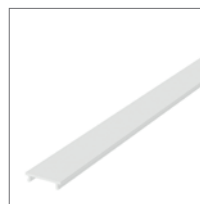

#### Diffusor

PMMA, opal

Länge	Art.-Nr.	CHF
2000 mm	411-226-062	26.20/m
3000 mm	411-226-063	26.20/m

### Endkappen



#### Endkappe

Aluminium

Variante	Art.-Nr.	CHF
	115-420-000	21.20

### Zubehör



#### Montageplatte

inkl. Schrauben, für horizontale oder vertikale Befestigung

Variante	Art.-Nr.	CHF
	115-420-100	10.50



#### Notlichtelement

vollautomatischer Selbsttest, 3 h, fertig in Profil montiert

Variante	Art.-Nr.	CHF
	UD-211-002-200	• 299.00

# Lineare LED-Module – Unsere Definition von Qualität

## Gleiche Leuchtdichte

Über die gesamte Länge des LED-Bandes bleibt die Leuchtdichte konstant.

## Optimale Wärmeableitung

Das applizierte, thermale Klebeband dient zur Montage in das Alu-Profil. Damit ist eine optimale Wärmeableitung garantiert.

## Wenig Blaulichtanteil

Bei der Entwicklung und Herstellung der LEDs war ein möglichst geringer Blaulichtanteil eine Priorität. Deswegen sind alle unsere Bänder Teil der Photobiologische Risikogruppe 1.

## Nanobeschichtung

Bei IP65 Anwendungen sind die LEDs mit einer speziellen Beschichtung für optimalen Schutz versehen.

## Binning

Das Sortieren bzw. Klassifizieren von Produktionschargen nennt man Binning. Damit können wir sicherstellen das bei Nachbestellungen keine Farbabweichungen vorkommen.

## SDCM

Die mögliche Abweichung zur angegebenen Farbtemperatur wird mit dem SDCM Index angegeben. Unsere Bänder erzielen hier Werte, die von bloßem Augen nicht mehr sichtbar sind.

## LED-Bänder



### 1-farbig

- 4 – 28 W/m
- 3 – 10 m
- 2200 – 6500 K



### Farben

- RGB
- RGB-W



### Dynamisches Weiss

- Tunable White
- Dim to Warm



### COB

- In allen Versionen: Weiss und Tunable White
- Licht ohne Unterbruch

## LED-Platinen

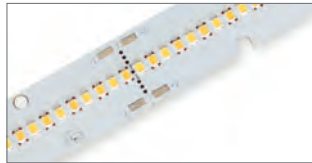

- starke Lumenpakete
- optimale Kühlung
- höchste Effizienz

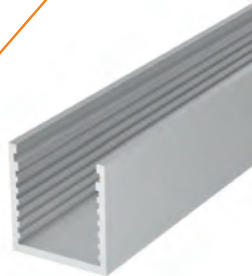

alle LED-Bänder geprüft mit unex Profilen, siehe Übersicht Seite 22

geprüft mit unex 24 V Treibern und Steuerungen





## LED-Bänder

W/m	Produkt	Länge	Breite	Farbtemperatur	Lichtfarbe	Seite
4	Unex Flex Back	5 m	8 mm	2700 K, 3000 K	weiss	88
8.5	Unex Flex Slim	5 m	5 mm	2200 K, 2500 K, 2700 K, 3000 K, 4000 K	weiss	89
9.6	Unex Flex	5 m	8 mm	2700 K, 3000 K, 4000 K	weiss	90
9.6	Unex Flex	10 m	8 mm	2700 K, 3000 K, 4000 K	weiss	90
9.6	Unex Flex IP65	5 m	8 mm	2700 K, 3000 K, 4000 K	weiss	91
12	Unex Flex High-Power	5 m	8 mm	2500 K, 2700 K, 3000 K, 4000 K, 6500 K	weiss	92
12	Unex Flex High-Power	10 m	8 mm	2500 K, 2700 K, 3000 K, 4000 K	weiss	92
14.4	Unex Flex High-Power IP65	5 m	8 mm	2700 K, 3000 K, 4000 K	weiss	93
19.2	Unex Flex 210	5 m	8 mm	2700 K, 3000 K, 4000 K	weiss	94
24	Unex Flex High Efficiency	5 m	12 mm	2700 K, 3000 K, 4000 K	weiss	94
<b>NEW</b> <b>NEW</b>	13 Unex Flex High Efficiency Plus	5 m	8 mm	2700 K, 3000 K, 4000 K	weiss	95
<b>NEW</b>	18.5 Unex Flex High Efficiency Plus	5 m	10 mm	2700 K, 3000 K, 4000 K	weiss	95
28	Unex Flex High Output	3 m	12 mm	2700 K, 3000 K, 4000 K	weiss	97
<b>NEW</b> <b>NEW</b>	11 Unex Flex COB	5 m	8 mm	2700 K, 3000 K, 4000 K	weiss	98
<b>NEW</b>	14 Unex Flex COB Tunable White	5 m	10 mm	2500 – 6500 K	weiss	98
19.2	Unex Flex Tunable White	5 m	10 mm	2300 – 6500 K	weiss	99
19.2	Unex Flex Dim to Warm	5 m	10 mm	2000 – 3200 K	weiss	99
19.2	Unex Flex RGB	5 m	10 mm		RGB	100
14.4	Unex Flex RGB IP65	5 m	10 mm		RGB	100
19.2	Unex Flex Top	5 m	12 mm	2600 K, 3000 K, 4000 K, 6000 K	RGB-RW, RGB-WW, RGB-NW, RGB-W	101

## LED-Platine

W/m	Produkt	Länge	Breite	Farbtemperatur	Lichtfarbe	Seite
27.5	Unex Rigid	1 m	24 mm	3000 K / 4000 K	weiss	103



## Unex Flex Back | LED-Band

Für Hinterleuchtung mit geringer Anschlussleistung und kleinen LED Abständen



4 W/m
420 lm/m
120 LED/m
2700 K, 3000 K
Abstrahlwinkel: 120°
50'000h L70 / t <sub>c</sub> max. = 60 °C
CRI 80
LxBxH: 5000 x 8 x 1.6 mm
Trenneinheit: 50 mm



### Informationen

- Niedrige installierte Leistung
- Gleiche Leuchtdichte über die komplette Länge
- Um die Wärmeableitung zu gewährleisten muss das LED-Band in ein Aluminium-Profil geklebt werden. Ansonsten entfällt die Garantie.

Farbtemperatur	EEK	Art.-Nr.	CHF
2700 K	F	DL/24V-RW-400	29.00/m
3000 K	G	DL/24V-WW-400	29.00/m



**Unex Flex Slim | LED-Band**

5 mm schlank

CRI  
90**Informationen**

- noch schmaler - jetzt nur 5 mm breit
- mehr LEDs pro Meter für eine bessere Gleichmäßigkeit, auch beim Dimmen
- Um die Wärmeableitung zu gewährleisten muss das LED-Band in ein Aluminium-Profil geklebt werden. Ansonsten entfällt die Garantie.

9 W/m

750 – 950 lm/m

140 LED/m

2200 K, 2500 K, 2700 K, 3000 K

4000 K

Abstrahlwinkel: 120°

50'000h L70 / t<sub>c</sub> max. = 60 °C

CRI 90

LxBxH: 5000 x 5 x 2.6 mm

Trenneinheit: 50 mm

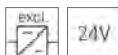

Farbtemperatur	Lichtstrom	EEK	Art.-Nr.	CHF
2200 K	750 lm/m	G	120-103-220	49.00/m
2500 K	780 lm/m	G	120-103-250	49.00/m
2700 K	850 lm/m	G	120-103-270	49.00/m
3000 K	850 lm/m	G	120-103-300	49.00/m
4000 K	950 lm/m	F	120-103-400	49.00/m

**Unex Flex 5 m | LED-Band**

die täglichen 9.6 W

CRI  
90

10.2 W/m
1000 lm/m, 1100 lm/m
140 LED/m
2700 K, 3000 K, 4000 K
Abstrahlwinkel: 120°
50'000h L70 / t <sub>c</sub> max. = 60 °C
CRI 90
LxBxH: 5000 x 8 x 3 mm
Trenneinheit: 50 mm

**Informationen**

- SDCM <3
- Gleiche Leuchtdichte über die komplette Länge
- Um die Wärmeableitung zu gewährleisten muss das LED-Band in ein Aluminium-Profil geklebt werden. Ansonsten entfällt die Garantie.

Farbtemperatur	Lichtstrom	Art.-Nr.	CHF
2700 K	1000 lm/m	120-110-270	49.00/m
3000 K	1000 lm/m	120-110-300	49.00/m
4000 K	1100 lm/m	120-110-400	49.00/m

**Unex Flex 10 m | LED-Band**

die täglichen 9.6 W – 10 m Länge mit einseitiger Einspeisung

CRI  
90

10.2 W/m
1000 lm/m, 1100 lm/m
140 LED/m
2700 K, 3000 K, 4000 K
Abstrahlwinkel: 120°
50'000h L70 / t <sub>c</sub> max. = 60 °C
CRI 90
LxBxH: 10000 x 8 x 3 mm
Trenneinheit: 50 mm

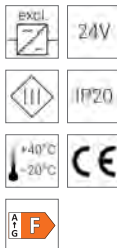
**Informationen**

- SDCM <3
- Gleiche Leuchtdichte über die komplette Länge
- Um die Wärmeableitung zu gewährleisten muss das LED-Band in ein Aluminium-Profil geklebt werden. Ansonsten entfällt die Garantie.

Farbtemperatur	Lichtstrom	Art.-Nr.	CHF
2700 K	1000 lm/m	120-111-270	49.00/m
3000 K	1000 lm/m	120-111-300	49.00/m
4000 K	1100 lm/m	120-111-400	49.00/m



## Unex Flex IP65 | LED-Band



9.6 W/m
960 lm/m, 1000 lm/m
120 LED/m
2700 K, 3000 K, 4000 K
Abstrahlwinkel: 120°
50'000h L70 / t <sub>c</sub> max. = 60 °C
CRI 80
LxBxH: 5000 x 8 x 2.7 mm
Trenneinheit: 50 mm



### Informationen

- Qualitäts-Nanobeschichtung
- Bitte beachten Sie, dass sämtliche Verarbeitungsschritte für ein Endprodukt in IP65 gewährleistet sein müssen.
- Um die Wärmeableitung zu gewährleisten muss das LED-Band in ein Aluminium-Profil geklebt werden. Ansonsten entfällt die Garantie.

	Farbtemperatur	Lichtstrom	EEK	Art.-Nr.	CHF
<b>NEW</b>	2700 K	960 lm/m	F	120-100-21	74.00/m
	3000 K	1000 lm/m	-	120-100-70	74.00/m
	4000 K	1000 lm/m	-	120-100-40	74.00/m

Zubehör	Art.-Nr.	CHF
Klebe-Dichtstoff, Silikon, 90 ml	25958-120-07	21.00



## Unex Flex High-Power 5 m | LED-Band

die täglichen 12 W

CRI  
90

12 W/m  
 1100 lm, 1200 lm, 1300 lm/m  
 140 LED/m  
 2500 K, 2700 K, 3000 K, 4000 K,  
 6500 K  
 Abstrahlwinkel: 120°  
 50'000h L70 / t<sub>c</sub> max. = 60 °C  
 CRI 90  
 LxBxH: 5000 x 8 x 3 mm  
 Trenneinheit: 50 mm



### Informationen

- SDCM <3
- Gleiche Leuchtdichte über die komplette Länge
- Um die Wärmeableitung zu gewährleisten muss das LED-Band in ein Aluminium-Profil geklebt werden. Ansonsten entfällt die Garantie.

Farbtemperatur	Lichtstrom	EEK	Art.-Nr.	CHF
2500 K	1100 lm/m	G	120-112-250	64.00/m
2700 K	1100 lm/m	G	120-112-270	64.00/m
3000 K	1200 lm/m	F	120-112-300	64.00/m
4000 K	1300 lm/m	F	120-112-400	64.00/m
6500 K	1300 lm/m	F	120-112-650	64.00/m

## Unex Flex High-Power 10 m | LED-Band

die täglichen 12 W – 10 m Länge mit einseitiger Einspeisung

CRI  
90

12 W/m  
 1100 lm, 1200 lm, 1300 lm/m  
 140 LED/m  
 2500 K, 2700 K, 3000 K, 4000 K,  
 6500 K  
 Abstrahlwinkel: 120°  
 50'000h L70 / t<sub>c</sub> max. = 60 °C  
 CRI 90  
 LxBxH: 10000 x 8 x 3 mm  
 Trenneinheit: 50 mm

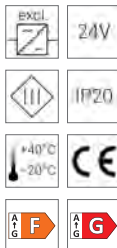

### Informationen

- SDCM <3
- Gleiche Leuchtdichte über die komplette Länge
- Um die Wärmeableitung zu gewährleisten muss das LED-Band in ein Aluminium-Profil geklebt werden. Ansonsten entfällt die Garantie.

Farbtemperatur	Lichtstrom	EEK	Art.-Nr.	CHF
2500 K	1100 lm/m	G	120-113-250	64.00/m
2700 K	1100 lm/m	G	120-113-270	64.00/m
3000 K	1200 lm/m	F	120-113-300	64.00/m
4000 K	1300 lm/m	F	120-113-400	64.00/m
6500 K	1300 lm/m	F	120-113-650	64.00/m

## Unex Flex High-Power IP65 | LED-Band



## Informationen

- Qualitäts-Nanobeschichtung
- Bitte beachten Sie, dass sämtliche Verarbeitungsschritte für ein Endprodukt in IP65 gewährleistet sein müssen.
- Um die Wärmeableitung zu gewährleisten muss das LED-Band in ein Aluminium-Profil geklebt werden. Ansonsten entfällt die Garantie.

14.4 W/m

1380 lm/m, 1440 lm/m,

1500 lm/m

120 LED/m

2700 K, 3000 K, 4000 K

Abstrahlwinkel: 120°

50'000h L70 / t<sub>c</sub> max. = 60 °C

CRI 80

LxBxH: 5000 x 8 x 2 mm

Trenneinheit: 50 mm



Farbtemperatur	Lichtstrom	Art.-Nr.	CHF
2700 K	1380 lm/m	120-101-21	99.00/m
3000 K	1440 lm/m	120-101-71	99.00/m
4000 K	1500 lm/m	120-101-41	99.00/m

Zubehör	Art.-Nr.	CHF
Klebe-Dichtstoff, Silikon, 90 ml	25958-120-07	21.00





## Unex Flex 210 | LED-Band

210 LED Chips pro Meter für Homogenität in kleinen Profilen

CRI  
90



19.2 W/m
1940 lm/m, 2000 lm/m, 2100 lm/m
210 LED/m
2700 K, 3000 K, 4000 K
Abstrahlwinkel: 120°
50'000h L70 / t <sub>c</sub> max. = 60 °C
CRI 90
LxBxH: 5000 x 8 x 2 mm
Trenneinheit: 33.3 mm



### Informationen

- geringer Abstand zwischen den LEDs (210 LED/m) für eine optimale Homogenität
- hohe Lichtausbeute mit 110 lm/W
- SDCM <3
- kleine Trenneinheit
- Gleiche Leuchtdichte über die komplette Länge
- Um die Wärmeableitung zu gewährleisten muss das LED-Band in ein Aluminium-Profil geklebt werden. Ansonsten entfällt die Garantie.

	Farbtemperatur	Lichtstrom	EEK	Art.-Nr.	CHF
<b>NEW</b>	2700 K	2000 lm/m	F	120-102-21	89.00/m
<b>NEW</b>	3000 K	2100 lm/m	F	120-102-71	89.00/m
	4000 K	1940 lm/m	-	120-102-40	89.00/m

## Unex Flex High Efficiency | LED-Band

Das starke Paket in schlanker Form

CRI  
90

NEW



24 W/m
2640 lm/m, 2760 lm/m, 2840 lm/m
128 LED/m
2700 K, 3000 K, 4000 K
CRI 90
Abstrahlwinkel: 120°
50'000h L70 / t <sub>c</sub> max. = 60 °C
LxBxH: 5000 x 12 x 2 mm
Trenneinheit: 62.5 mm

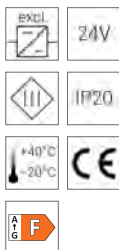

### Informationen

- hohe Lichtausbeute mit 110 lm/W
- SDCM <3
- Gleiche Leuchtdichte über die komplette Länge
- Um die Wärmeableitung zu gewährleisten muss das LED-Band in ein Aluminium-Profil geklebt werden. Ansonsten entfällt die Garantie.

	Farbtemperatur	Lichtstrom	Art.-Nr.	CHF
	2700 K	2640 lm/m	120-104-271	109.00/m
	3000 K	2760 lm/m	120-104-301	109.00/m
	4000 K	2840 lm/m	120-104-401	109.00/m

**Unex Flex Efficiency Plus 13 W/m | LED-Band**CRI  
90

NEW

Energieeffizienz optimiert



13 W/m
1600 lm/m, 1700 lm/m, 1800 lm/m
160 LED/m
2700 K, 3000 K, 4000 K
Abstrahlwinkel: 120°
50'000h L70 / t <sub>c</sub> max. = 60 °C
CRI 90
LxBxH: 5000 x 8 x 2.5 mm
Trenneinheit: 50 mm

**Informationen**

- sehr hohe Lichtausbeute mit bis zu 138 lm/W
- SDCM <3
- Gleiche Leuchtdichte über die komplette Länge
- Um die Wärmeableitung zu gewährleisten muss das LED-Band in ein Aluminium-Profil geklebt werden. Ansonsten entfällt die Garantie.

Farbtemperatur	Lichtstrom	Art.-Nr.	CHF
2700 K	1600 lm/m	120-118-270	79.00/m
3000 K	1700 lm/m	120-118-300	79.00/m
4000 K	1800 lm/m	120-118-400	79.00/m

**Unex Flex Efficiency Plus 18.5 W/m | LED-Band**CRI  
90

NEW

Energieeffizienz optimiert



18.5 W/m
2060 lm/m, 2250 lm/m, 2400 lm/m
160 LED/m
2700 K, 3000 K, 4000 K
Abstrahlwinkel: 120°
50'000h L70 / t <sub>c</sub> max. = 60 °C
CRI 90
LxBxH: 5000 x 10 x 2.5 mm
Trenneinheit: 50 mm

**Informationen**

- sehr hohe Lichtausbeute mit bis zu 130 lm/W
- SDCM <3
- Gleiche Leuchtdichte über die komplette Länge
- Um die Wärmeableitung zu gewährleisten muss das LED-Band in ein Aluminium-Profil geklebt werden. Ansonsten entfällt die Garantie.

Farbtemperatur	Lichtstrom	EEK	Art.-Nr.	CHF
2700 K	2060 lm/m	F	120-119-270	99.00/m
3000 K	2250 lm/m	E	120-119-300	99.00/m
4000 K	2400 lm/m	E	120-119-400	99.00/m





## Unex Flex High Output | LED-Band

Volle Power in höchster Effizienz 130 lm/W

CRI  
90



### Informationen

- hoher Lumenoutput mit 3600 lm/m
- SDCM <3
- Gleiche Leuchtdichte über die komplette Länge
- Um die Wärmeableitung zu gewährleisten muss das LED-Band in ein Aluminium-Profil geklebt werden. Ansonsten entfällt die Garantie.

28 W/m

3600 lm/m, 3700 lm/m

160 LED/m

2700 K, 3000 K, 4000 K

Abstrahlwinkel: 120°

50'000h L70 / t<sub>c</sub> max. = 60 °C

CRI 90

LxBxH: 3000 x 12 x 2 mm

Trenneinheit: 50 mm

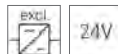

Farbtemperatur	Lichtstrom	Art.-Nr.	CHF
2700 K	3600 lm/m	120-105-270	129.00/m
3000 K	3600 lm/m	120-105-300	129.00/m
4000 K	3700 lm/m	120-105-400	129.00/m

## Unex Flex COB | LED-Band

homogen in kleinen Profilen

CRI  
90

NEW



11 W/m
1000 lm/m, 1060 lm/m, 1160 lm/m
480 LED/m
2700 K, 3000 K, 4000 K
Abstrahlwinkel: 140°
30'000h L70 B50 / t <sub>c</sub> max. = 65 °C
CRI 90
LxBxH: 5000 x 8 x 2 mm
Trenneinheit: 50 mm



### Informationen

- SDCM <3
- keine sichtbaren LED-Punkte für einen optimalen Lichteffect, auch in kleinen Profilen
- Um die Wärmeableitung zu gewährleisten muss das LED-Band in ein Aluminium-Profil geklebt werden. Ansonsten entfällt die Garantie.

Farbtemperatur	Lichtstrom	EEK	Art.-Nr.	CHF
2700 K	1000 lm/m	G	120-114-270	89.00/m
3000 K	1060 lm/m	F	120-114-300	89.00/m
4000 K	1160 lm/m	F	120-114-400	89.00/m

## Unex Flex COB Tunable White | LED-Band

Tunable in seiner kleinsten Form

CRI  
90

NEW



14 W/m
450 – 1050 lm/m
608 LED/m
2500 – 6500 K
Abstrahlwinkel: 140°
30'000h L70 B50 / t <sub>c</sub> max. = 65 °C
CRI 90
LxBxH: 5000 x 10 x 2 mm
Trenneinheit: 50 mm



### Informationen

- Farbtemperatur von 2500 bis 6500 K einstellbar
- bis zu 1050 lm/m wenn beide LED-Chips eingeschaltet sind
- keine sichtbaren LED-Punkte für einen optimalen Lichteffect, auch in kleinen Profilen
- Um die Wärmeableitung zu gewährleisten muss das LED-Band in ein Aluminium-Profil geklebt werden. Ansonsten entfällt die Garantie.

Farbtemperatur	Lichtstrom	Art.-Nr.	CHF
2500 – 6500 K	450 – 1050 lm/m	120-116-890	119.00/m

## Unex Flex Tunable White | LED-Band

Veränderbare Farbtemperatur

CRI  
90



21 W/m
900 – 1900 lm/m
280 LED/m
2400 – 6000 K
Abstrahlwinkel: 120°
50'000h L70 / t <sub>c</sub> max. = 60 °C
CRI 90
LxBxH: 5000 x 8 x 2.5 mm
Trenneinheit: 50 mm

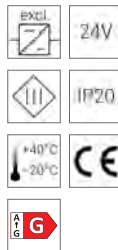

### Informationen

- Farbtemperatur von 2400 bis 6000 K einstellbar
- bis zu 2100 lm/m wenn beide LED-Chips eingeschaltet sind
- Gleiche Leuchtdichte über die komplette Länge
- Um die Wärmeableitung zu gewährleisten muss das LED-Band in ein Aluminium-Profil geklebt werden. Ansonsten entfällt die Garantie.

Farbtemperatur	Art.-Nr.	CHF
2400 – 6000 K	120-108-890	99.00/m

Empfohlene Steuerungen	Seite
Konstantspannungs-Treiber, DALI 2, 18 – 50 W	394
Konstantspannungs-Treiber, DALI 2, 30 – 80 W	395
Konstantspannungs-Treiber, DALI 2, DT6 oder DT8 TW, 60 – 160 W	395
Steuermodul, DALI DT8 TW	409

## Unex Flex Dim to Warm | LED-Band

CRI  
90



19.2 W/m
1500 lm/m
240 LED/m
2000 – 3200 K
Abstrahlwinkel: 120°
50'000h L70 / t <sub>c</sub> max. = 60 °C
CRI 90
LxBxH: 5000 x 10 x 2 mm
Trenneinheit: 50 mm

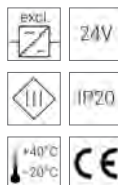

### Informationen

- Farbtemperatur von 2000 bis 3200 K durch Dimmung einstellbar
- funktioniert nur mit PWM-Dimmung

Farbtemperatur	Art.-Nr.	CHF
2000 – 3200 K	120-109-880	109.00/m



## Unex Flex RGB | LED-Band

RGB mit Power



19.2 W/m
1200 lm/m
98 LED/m
Abstrahlwinkel: 120°
50'000h L70 / t <sub>c</sub> max. = 60 °C
LxBxH: 5000 x 10 x 3 mm
Trenneinheit: 71.4 mm

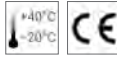
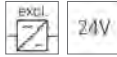

### Informationen

- sehr gute Homogenität dank 98 LED/m
- 6.4 W pro Farbe (0.27 A)
- lebendige Farben  
(Rot: 630 nm, Grün: 520 nm, Blau: 465 nm)
- Um die Wärmeableitung zu gewährleisten muss das LED-Band in ein Aluminium-Profil geklebt werden. Ansonsten entfällt die Garantie.

Lichtfarbe	Art.-Nr.	CHF
RGB	120-106-900	89.00/m

Empfohlene Steuerungen	Seite
Konstantspannungs-Treiber, DALI 2, 18 – 50 W	394
Konstantspannungs-Treiber, DALI 2, 30 – 80 W	395
Steuermodul, DALI DT8 RGB(W)	410

## Unex Flex RGB IP65 | LED-Band



14.4 W/m
60 LED/m
Abstrahlwinkel: 120°
50'000h L70 / t <sub>c</sub> max. = 60 °C
LxBxH: 5000 x 10 x 3 mm
Trenneinheit: 100 mm

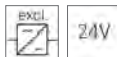

### Informationen

- Qualitäts-Nanobeschichtung
- 4.8 W pro Farbe (0.2 A)
- Farben: rot/grün/blau
- Bitte beachten Sie, dass sämtliche Verarbeitungsschritte für ein Endprodukt in IP65 gewährleistet sein müssen.
- Um die Wärmeableitung zu gewährleisten muss das LED-Band in ein Aluminium-Profil geklebt werden. Ansonsten entfällt die Garantie.

Lichtfarbe	Art.-Nr.	CHF
RGB	120-101-60	119.00/m

Zubehör	Art.-Nr.	CHF
Klebe-Dichtstoff, Silikon, 90 ml	25958-120-07	21.00

Empfohlene Steuerungen	Seite
Konstantspannungs-Treiber, DALI 2, 18 – 50 W	394
Konstantspannungs-Treiber, DALI 2, 30 – 80 W	395
Steuermodul, DALI DT8 RGB(W)	410

## Unex Flex Top | LED-Band

RGB mit präzisiertem Weiss



19.2 W/m
1100 lm/m, 1200 lm/m
120 LED/m
2600 K, 3000 K, 4000 K, 6000 K 6500 K
Abstrahlwinkel: 120°
50'000h L70 / t <sub>c</sub> max. = 60 °C
LxBxH: 5000 x 12 x 2.5 mm
Trenneinheit: 100 mm



### Informationen

- RGB-Farben und echte, weisse Farbtemperaturen dank 2 LED-Chips
- bis zu 1200 lm/m wenn beide LED-Chips eingeschaltet sind
- 4.8 W pro Farbe (0.2 A)
- Um die Wärmeableitung zu gewährleisten muss das LED-Band in ein Aluminium-Profil geklebt werden. Ansonsten entfällt die Garantie.

Farbtemperatur/Lichtfarbe	Lichtstrom	Art.-Nr.	CHF
2600 K, RGB-RW	1100 lm/m	120-107-950	109.00/m
3000 K, RGB-WW	1100 lm/m	120-107-960	109.00/m
4000 K, RGB-NW	1200 lm/m	120-107-970	109.00/m
6000 K, RGB-W	1200 lm/m	120-107-980	109.00/m

### Empfohlene Steuerungen

Empfohlene Steuerungen	Seite
Konstantspannungs-Treiber, DALI 2, 18 – 50 W	394
Konstantspannungs-Treiber, DALI 2, 30 – 80 W	395
Steuermodul, DALI DT8 RGB(W)	410







**Unex Rigid | LED-Platine**

Konstantstromlösung für höchste Effizienz

CRI  
90

27.5 W/m, 34 W/m, 41 W/m  
 4300 lm/m, 5100 lm/m, 5700 lm/m  
 220 LED/m  
 3000 K / 4000 K  
 Abstrahlwinkel: 120°  
 60'000h L80 / t<sub>c</sub> max. = 80 °C  
 CRI 90  
 LxBxH: 1000 x 24 x 3 mm  
 Trenneinheit: 100 mm  
 1000 mA, 1200 mA, 1400 mA  
 U<sub>F</sub> 27 V, 28 V, 29 V

**Informationen**

- 3000 oder 4000 Kelvin über Push-in-Anschluss einstellbar
- 110 LED/m pro Lichtfarbe
- bis zu 156 lm/W
- bei 1000 oder 1200 mA können bis zu 2 m mit nur 1 Treiber betrieben werden
- bei 1400 mA ist 1 Treiber pro Meter nötig
- Farben mischbar (max. 1400 mA)
- Reihenschaltung ab 1 m Länge
- Mindestlänge: 700 mm
- SELV LED-Modul (<60 V)
- SDCM <3

Farbtemperatur	Art.-Nr.	CHF
3000 K / 4000 K	190-001-001	148.90/m

Empfohlene Treiber	Seite	Art.-Nr.	CHF
 80 W, 350 – 1400 mA, DALI 2	406	200-011-080	109.00

## Nex Flex – Der flexible Allrounder



**Nex Flex ist eine flexible Bandleuchte.**  
Sie wurde für nur ein Ziel konzipiert: grösstmöglichen Spielraum bei der Entwicklung von Ideen und Beleuchtungskonzepten zu gewähren.

Die horizontal oder vertikal biegbaren Bänder ermöglichen präzise Kurven und aussergewöhnliche Formen. Es können auch elegante, lange Geraden realisiert werden – mit Nex Flex werden Gebäude und Räume garantiert zum Blickfang.

Die ausgezeichnete Gleichmässigkeit der Beleuchtung und die überlegene Leistung, auch unter Wasser, machen Nex Flex zur idealen Lösung für Innen und Aussen.

Umgebungstemperaturen von  $-20$  bis  $+45$  °C sind für Nex Flex kein Problem (max. Oberflächentemperatur  $+60$  °C).

### **NEU: Spezial-Silikon-Ausführungen für Fassendenanwendungen**

Alle Nex Flex Bandleuchten gibt es ab sofort auch in Spezial-Silikon. Gegenüber den Standard-Ausführungen bieten diese eine noch bessere UV-Beständigkeit. Sie sind auch für grössere Temperaturschwankungen geeignet:  $-40$  bis  $+50$  °C (max. Oberflächentemperatur  $+85$  °C).

### **Hinweis**

Nex Flex Bänder erfordern eine hohe Sorgfalt bei der Konfektionierung. Nur ein geschultes Personal mit entsprechender Ausrüstung garantiert diese fachgerechte Aufbereitung. Aus diesem Grund bieten wir Nex Flex bereits fertig konfektioniert an.

Möchten auch Sie über dieses Know-How verfügen? Gerne machen wir Sie zum Nex Flex Profi. Melden Sie sich gleich für eine Produktschulung an. Neben vertieften Produktkenntnissen erhalten Sie auch das passende Werkzeug und ein Zertifikat – damit dürfte einer erfolgreichen Installation nichts mehr im Wege stehen.

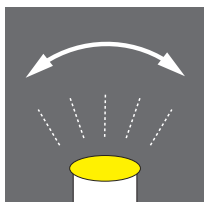

Verschiedene Abstrahlwinkel

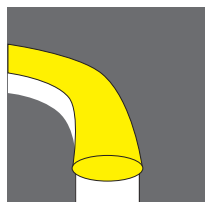

Flexibel, biegsam



Glühdraht- und Selbstverlöschungsprüfung bestanden

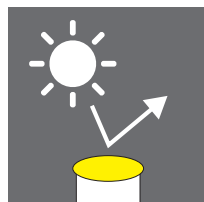

UV-beständig (inkl. Einspeisung)



Abrieb- und chemikalienbeständig

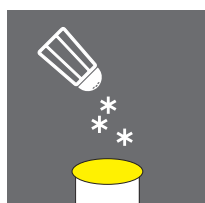

Salzbeständig

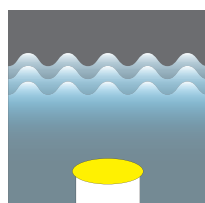

Chlorbeständig IP20 – IP68

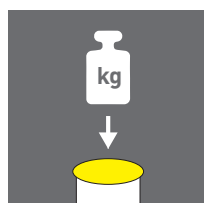

IK08



Neu: mit 3-seitigem Lichtaustritt



#### Einfach zu montieren

Bis zu 15 m lassen sich einseitig einspeisen. Bei 2-seitiger Einspeisung sind es 30 m. Bei der Spezial-Silikon-Version sind es sogar 20 m bzw. 40 m.



#### Design im Detail

Die elegante Einspeisung widerspiegelt die Liebe zum Detail. Genauso breit wie das Profil, ist sie praktisch unsichtbar von vorne und bietet Licht bis zum Ende.

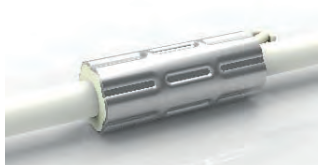

#### Wasserstop für noch mehr Sicherheit

Das Einspeisekabel verfügt über einen Wasserstop. Dieser verhindert das Eindringen von Wasser in die Leuchte über das Kabel.



#### Wasserdicht – bis zu 2 m unter Wasser, Pool zertifiziert

Doppelt-Eingespritzte Komponenten machen Nex Flex wasserdicht (bis zu IP68). So lassen sich auch Pools oder Brunnen inszenieren (UL-676 zertifiziert).



Die wichtigsten Montagehinweise in 3 Minuten.













Auf dem höchsten Wohnhaus der Schweiz, dem Jabee-Tower in Dübendorf, thront die flexible Bandleuchte Nex Flex.



# Nex Flex – Der flexible Allrounder



Ex Zone 2

## Nex Flex F23 LED | Flexible Bandleuchte



4.5 W/m  
 140 lm/m  
 144 LED/m  
 2700 K, 3000 K  
 Abstrahlwinkel: 160°  
 50'000h L70  
 CRI 80  
 Trenneinheit: 83.3 mm

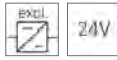
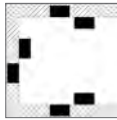

### Informationen

- 10 m Länge mit einseitiger Einspeisung möglich, bzw. 20 m bei 2-seitiger Einspeisung
- dimmbar
- aus PVC
- horizontal biegsam bis zu einem Radius von 50 mm
- weitere Varianten (vertikal biegsam, 4000 K, IP65, ...) auf Anfrage

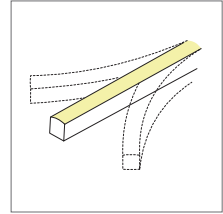
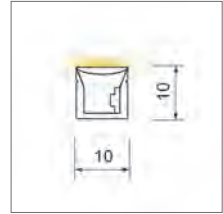

Farbtemperatur	Art.-Nr.	CHF
2700 K	120-005-20	127.50/m
3000 K	120-005-70	127.50/m

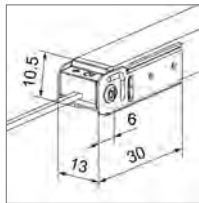

### Einspeisung, Swivel

IP20, 1000 mm

Variante	Art.-Nr.	CHF
rechts (01)	120-005-90	14.90
links (02)	120-005-91	14.90

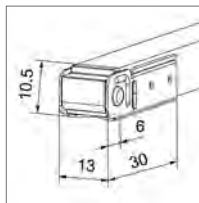

### Endkappe, Swivel

IP20

Variante	Art.-Nr.	CHF
	120-005-88	5.20

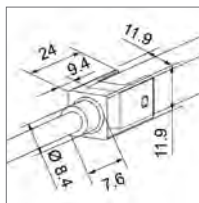

### Einspeisung, Socket

IP65, 1000 mm

Variante	Art.-Nr.	CHF
rechts (01)	120-005-86	17.50
links (02)	120-005-87	17.50

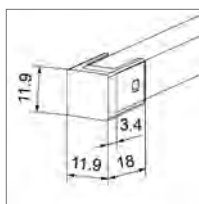

### Endkappe, Socket

IP65

Variante	Art.-Nr.	CHF
	120-005-85	7.50

## Nex Flex F23 LED | Flexible Bandleuchte

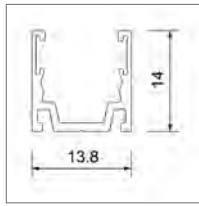

### Montageprofil, gezahnt

Aluminium

Länge	Art.-Nr.	CHF
20 mm	120-005-97	4.20
2000 mm	120-005-96	65.00

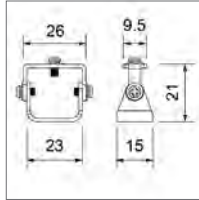

### Schwenkbare Halterung

für alle Nex Flex Montageprofile, inkl. 1 Schraube, Aluminium

Variante	Art.-Nr.	CHF
	120-001-01	13.80

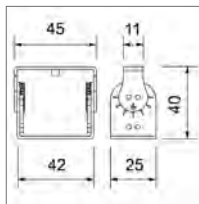

### Schwenkbare Halterung, gross

für alle Profile, inkl. 1 Schraube, in 15° Schritten einstellbar, Aluminium

Variante	Art.-Nr.	CHF
	120-001-05	21.50

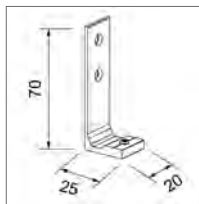

### L-Halterung

für alle Nex Flex Montageprofile, inkl. 1 Schraube, Aluminium

Variante	Art.-Nr.	CHF
	120-001-02	13.80



## Nex Flex F15 LED | Flexible Bandleuchte



## Informationen

- auch für den Aussenbereich einsetzbar
- 10 m Länge mit einseitiger Einspeisung möglich, bzw. 20 m bei 2-seitiger Einspeisung
- dimmbar
- aus PVC
- horizontal biegbar bis zu einem Radius von 60 mm
- weitere Varianten (RGBW, IP68, ...) auf Anfrage

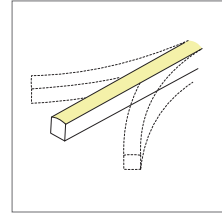
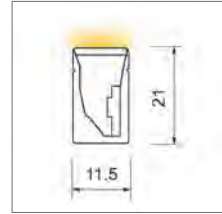

12 W/m
110 – 320 lm/m
72/60 LED/m
2700 K, 3000 K, 4000 K, RGB
Abstrahlwinkel: 160°
50'000h L70
CRI 80
Trenneinheit: 83.3/100 mm

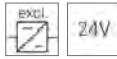
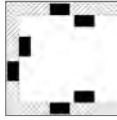

Farbtemperatur	Trenneinheit	LED/m	Art.-Nr.	CHF
2700 K	83.3 mm	72	120-001-20	148.90/m
3000 K	83.3 mm	72	120-001-70	148.90/m
4000 K	83.3 mm	72	120-001-40	148.90/m

Lichtfarbe	Trenneinheit	LED/m	Art.-Nr.	CHF
RGB	100 mm	60	120-002-60	159.50/m

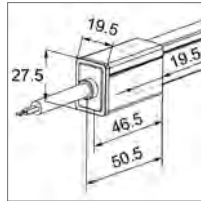

## Einspeisung, frontal

IP67, Länge: 1000 mm

Variante	Art.-Nr.	CHF
Weiss, rechts (01)	120-001-90	21.20
Weiss, links (02)	120-001-91	21.20
RGB, rechts (01)	120-002-90	21.20
RGB, links (02)	120-002-91	21.20

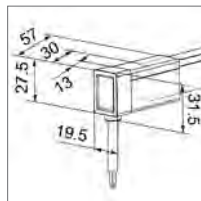

## Einspeisung, unten

IP67, Länge: 1000 mm

Variante	Art.-Nr.	CHF
Weiss, rechts (01)	120-001-82	21.20
Weiss, links (02)	120-001-81	21.20
RGB, rechts (01)	120-002-82	21.20
RGB, links (02)	120-002-81	21.20

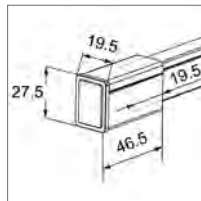

## Endkappe

IP67

Variante	Art.-Nr.	CHF
rechts (01)	120-001-88	7.40
links (02)	120-001-89	7.40

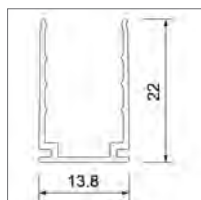

## Montageprofil

Aluminium

Länge	Art.-Nr.	CHF
35 mm	120-001-96	4.20
2000 mm	120-001-97	42.70

## Nex Flex F15 LED | Flexible Bandleuchte

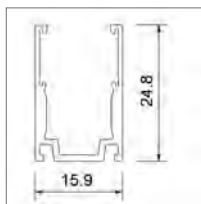
**Montageprofil, gezahnt**

Aluminium

Länge	Art.-Nr.	CHF
20 mm	120-001-95	10.60
2000 mm	120-001-94	65.00

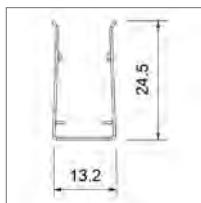
**Montageprofil, biegsam**

Länge	Art.-Nr.	CHF
900 mm	120-001-83	42.70

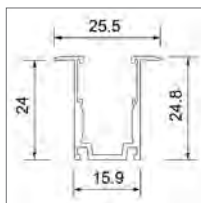
**Montageprofil, mit Kragen, gezahnt**

Länge	Art.-Nr.	CHF
2000 mm	120-001-80	75.90

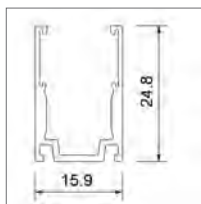
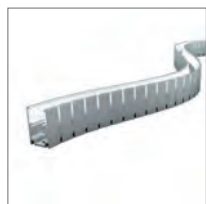
**Montageprofil, gezahnt, horizontal biegsam**

Aluminium

Länge	Art.-Nr.	CHF
1000 mm	120-001-84	53.40

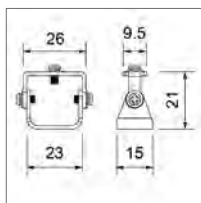
**Schwenkbare Halterung**

für alle Nex Flex Montageprofile, inkl. 1 Schraube, Aluminium

Variante	Art.-Nr.	CHF
	120-001-01	13.80

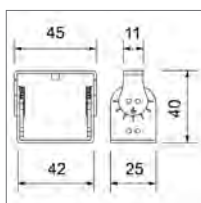
**Schwenkbare Halterung, gross**

für alle Profile, inkl. 1 Schraube, in 15° Schritten einstellbar, Aluminium

Variante	Art.-Nr.	CHF
	120-001-05	21.50

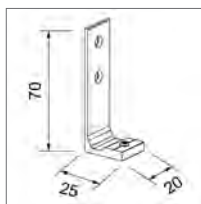
**L-Halterung**

für alle Nex Flex Montageprofile, inkl. 1 Schraube, Aluminium

Variante	Art.-Nr.	CHF
	120-001-02	13.80

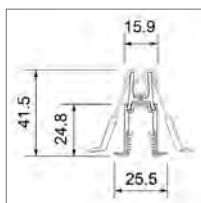
**Hohldecken-Einbauhalterung**

für Montageprofile mit Kragen F11/F15/F21, inkl. 1 Schraube, Aluminium

Variante	Art.-Nr.	CHF
	120-001-03	9.50

## Nex Flex F16 LED | Flexible Bandleuchte

für Indirektbeleuchtung



### Informationen

- auch für den Aussenbereich einsetzbar
- 10 m Länge mit einseitiger Einspeisung möglich, bzw. 20 m bei 2-seitiger Einspeisung
- dimmbar
- aus PVC
- vertikal biegsam bis zu einem Radius von 25 mm
- weitere Varianten (RGBW, IP65 eingespritzt, ...) auf Anfrage

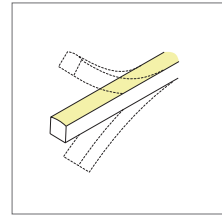
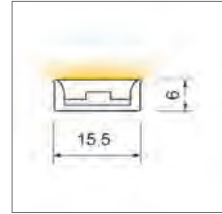

12 W/m
300 – 900 lm/m
72/60 LED/m
3000 K, RGB
Abstrahlwinkel: 160°
50'000h L70
CRI 80
Trenneinheit: 83.3/100 mm

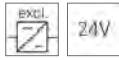
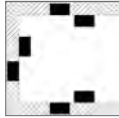

Farbtemperatur	Trenneinheit	LED/m	Art.-Nr.	CHF
3000 K	83.3 mm	72	120-003-70	106.00/m
4000 K	83.3 mm	72	120-003-40	106.00/m

Lichtfarbe	Trenneinheit	LED/m	Art.-Nr.	CHF
RGB	100 mm	60	120-004-60	116.60/m

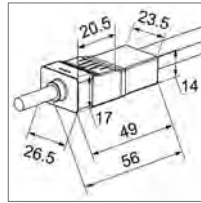
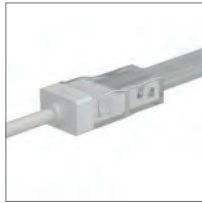

### Einspeisung

IP67, Länge: 1000 mm

Variante	Art.-Nr.	CHF
Weiss, rechts (01)	120-003-90	21.20
Weiss, links (02)	120-003-91	21.20
RGB, rechts (01)	120-004-90	21.20
RGB, links (02)	120-004-91	21.20

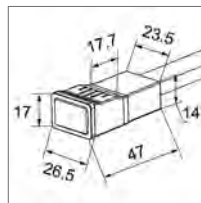

### Endkappe

IP67

Variante	Art.-Nr.	CHF
rechts (01)	120-003-89	10.60
links (02)	120-003-88	10.60

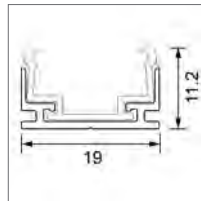
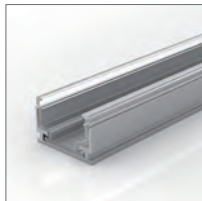

### Montageprofil

Alu-Kunststoff

Länge	Art.-Nr.	CHF
35 mm	120-003-96	4.20
2000 mm	120-003-97	53.40

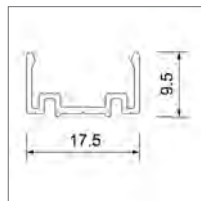

### Montageprofil

Aluminium, mit Abdeckung

Länge	Art.-Nr.	CHF
2000 mm	120-003-95	53.40

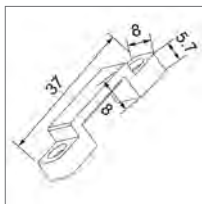

## Nex Flex F16 LED | Flexible Bandleuchte

**Befestigungselement**

Kunststoff

Länge	Art.-Nr.	CHF
8 mm	120-003-98	3.10

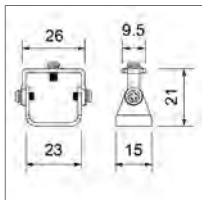
**Schwenkbare Halterung**

für alle Nex Flex Montageprofile, inkl. 1 Schraube, Aluminium

Variante	Art.-Nr.	CHF
	120-001-01	13.80

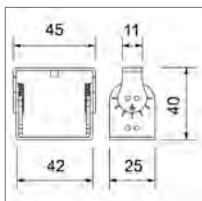
**Schwenkbare Halterung, gross**

für alle Profile, inkl. 1 Schraube, in 15° Schritten einstellbar, Aluminium

Variante	Art.-Nr.	CHF
	120-001-05	21.50

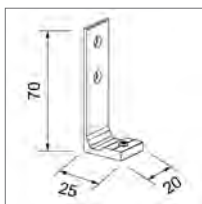
**L-Halterung**

für alle Nex Flex Montageprofile, inkl. 1 Schraube, Aluminium

Variante	Art.-Nr.	CHF
	120-001-02	13.80

## Nex Flex F22 LED | Flexible Bandleuchte

Vertikal oder horizontal biegbare Versionen oder mit High output



### Informationen

- auch für den Aussenbereich einsetzbar
- Max. Länge bei einseitiger Einspeisung: 10 m (12 W/m), bzw. 8 m (15 W/m)
- Max. Länge bei 2-seitige Einspeisung 20 m (12 W/m), bzw. 16 m (15 W/m)
- dimmbar
- aus PVC
- biegbar bis zu einem Radius von 150 mm
- weitere Varianten (TW, RGB, RGBW, IP68, ...) auf Anfrage

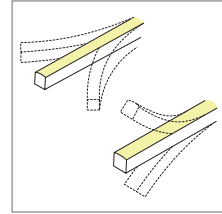
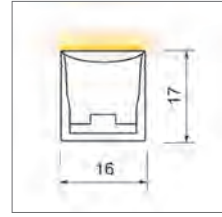

12 W/m, 15 W/m  
400 – 800 lm/m  
108 LED/m  
2700 K, 3000 K  
Abstrahlwinkel: 160°  
50'000h L70  
CRI 80  
Trenneinheit: 55.6 mm

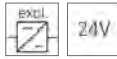
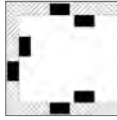

Hinweis	Farbtemperatur	Leistung	Lichtstrom	Art.-Nr.	CHF
horizontal biegbar	2700 K	12 W/m	400 lm/m	120-006-20	191.50/m
horizontal biegbar	3000 K	12 W/m	400 lm/m	120-006-70	191.50/m
vertikal biegbar	2700 K	15 W/m	800 lm/m	120-006-23	212.90/m
vertikal biegbar	3000 K	15 W/m	800 lm/m	120-006-73	212.90/m

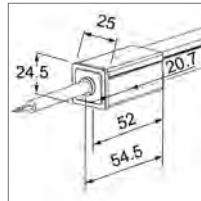

### Einspeisung, frontal

IP67, Länge: 1000 mm

Hinweis	Art.-Nr.	CHF
horizontal, rechts (01)	120-006-93	21.20
horizontal, links (02)	120-006-90	21.20
vertikal, rechts (01)	120-006-92	21.20
vertikal, links (02)	120-006-91	21.20

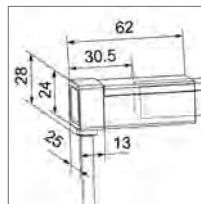

### Einspeisung, unten

IP67, Länge: 1000 mm

Hinweis	Art.-Nr.	CHF
horizontal, rechts (01)	120-006-82	21.20
horizontal, links (02)	120-006-80	21.20
vertikal, rechts (01)	120-006-81	21.20
vertikal, links (02)	120-006-79	21.20

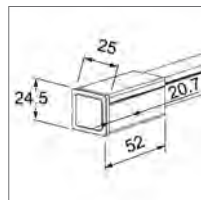

### Endkappe

IP67

Hinweis	Art.-Nr.	CHF
horizontal, rechts (01)	120-006-88	10.60
horizontal, links (02)	120-006-86	10.60
vertikal, rechts (01)	120-006-89	10.60
vertikal, links (02)	120-006-85	10.60

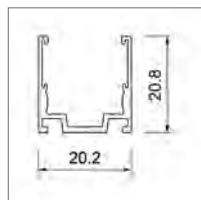

### Montageprofil, gezahnt

Aluminium

Länge	Art.-Nr.	CHF
20 mm	120-006-97	10.60
2000 mm	120-006-96	65.00

## Nex Flex F22 LED | Flexible Bandleuchte

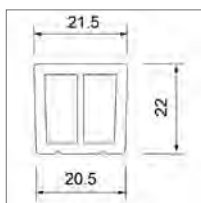
**Einbetonierhilfe**

Kunststoff, BxH: 21.5 x 22 mm, für Putzdecke, leicht konisch für eine einfachere und schnellere Ausschalung

Länge	Art.-Nr.	CHF
3000 mm	960-180-213	96.00

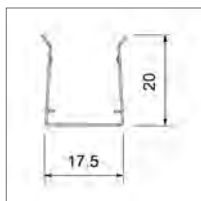
**Montageprofil, biegebar**

Aluminium

Länge	Art.-Nr.	CHF
900 mm	120-006-83	42.70

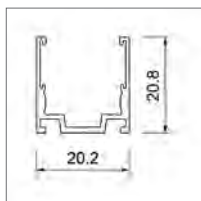
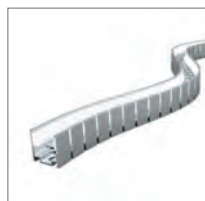
**Montageprofil, gezahnt, horizontal biegebar**

Aluminium

Länge	Art.-Nr.	CHF
1000 mm	120-006-84	53.40

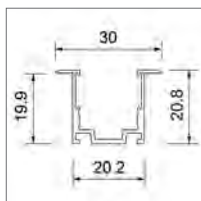
**Montageprofil, mit Kragen, gezahnt**

Länge	Art.-Nr.	CHF
2000 mm	120-006-94	75.90

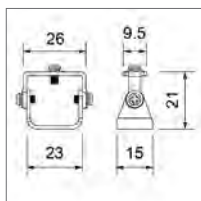
**Schwenkbare Halterung**

für alle Nex Flex Montageprofile, inkl. 1 Schraube, Aluminium

Variante	Art.-Nr.	CHF
	120-001-01	13.80

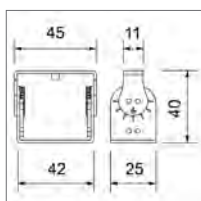
**Schwenkbare Halterung, gross**

für alle Profile, inkl. 1 Schraube, in 15° Schritten einstellbar, Aluminium

Variante	Art.-Nr.	CHF
	120-001-05	21.50

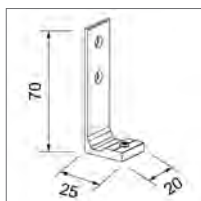
**L-Halterung**

für alle Nex Flex Montageprofile, inkl. 1 Schraube, Aluminium

Variante	Art.-Nr.	CHF
	120-001-02	13.80

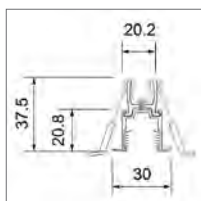
**Hohldecken-Einbauhalterung**

für Montageprofile mit Kragen F22, inkl. 1 Schraube, Aluminium

Variante	Art.-Nr.	CHF
	120-001-04	9.50





Einbau-Downlight  
**Swing 68 Plan**





## Downlights – kompakte Highlights

Unser umfangreiches Sortiment reicht von attraktiven Standards wie EcoLED bis zu den hoch entblendeten Zenta Downlights, von Pico LED (Licht aus dem Loch) bis zu den Einbaurichtstrahlern der Familie Mira, alles in Top Qualität hinsichtlich Lichttechnik, Installation und Effizienz.

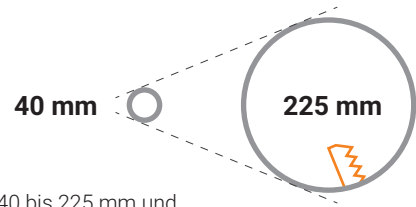

Bohrlöcher von 40 bis 225 mm und Einbautiefen von 10 bis 153 mm decken wir mit unserem Programm ab - da bleiben wahrlich keine Wünsche offen.

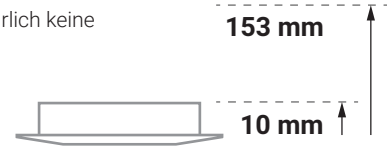

### Zenta

beste Entblendung UGR < 19,  
Tunable White Version erhältlich,  
alles in IP44



### Mira

Die komplette Familie – für  
Bohrlöcher von 68 bis 150 mm,  
in CRI 90



### Pico

Licht aus dem Loch



### RIDL Karda

20° kardanisich schwenkbar,  
beste Lichtverteilung durch  
hochwertige Reflektoren,  
flache Bauform und steck-  
bare Anschlusskabel für eine  
optimale Installation



### EcoLED

effizient, variable Lumenpakete,  
grosses Programm, in IP44

### Installationsmöglichkeiten



Beton, verputzt



Sichtbeton



Gips



Möbeleinbau



# Der RIDL-Baukasten – für grenzenlose Flexibilität

RIDL steht für hochwertigstes Licht in kompakter Form. Top Lichttechnik durch Reflektortechnik, bestes Thermomanagement gepaart mit bester Treibertechologie und Dimmbarkeit auf bestem Niveau.

## Trieber und Steuerungen



## Leuchtmittel

<b>RIDL 7 GU10</b>	<b>RIDL 8 II</b>	<b>RIDL 8 Dim to Warm</b>	<b>RIDL 9</b>	<b>RIDL 9 Vivid</b>	<b>RIDL 13</b>	<b>RIDL 13 TW</b>
7.6 W	6.1 W	0.2 - 6.3 W	9 W	9 W	12 W	12.5 W
20°/38°	20°/38°	38°	38°/60°	38°	38°/60°	38°
2700/3000K	2700/3000/4000K	2000 – 2800K	2700/3000/4000K	3000K	2700/3000/4000K	2700 – 6500K

## Reflektoren

20°	60°	20°, gold	38°, gold

## Deckeneinbauringe

<b>Swing</b>	<b>Twist</b>	<b>Concave</b>	<b>Mood</b>	<b>Mood Trimless</b>	<b>Disc</b>
68/68 Plan 80/80 Plan	80 Plan/80 Square Plan 100 Plan 2X Square Plan				



### Tunable White

Die ganze Bandbreite von Weiss - in jeder Intensität. Ob mit einem Dimmer angesteuert oder im Tageslichtverlauf – ganz nach Ihrem Bedarf.





### Dim to Warm

bringt das Ambiente einer Halogenlampe in Ihre Räumlichkeiten

# Bohrlöcher

## Deckenauschnitte

### Einbau-Downlights

	Name	Ø / LxB	EBT	Seite		Name	Ø / LxB	EBT	Seite
<b>40</b>	Pico LED	50	68	183	<b>80</b>	Swing 80 GU10	90	91	137
<b>58</b>	Vario LED	70	19	157		Swing 80 RIDL 7	90	124	138
<b>68</b>	Swing 68 GU10	82	91	127		Swing 80 mit RIDL 8 II	90	67	139
	Swing 68 RIDL 7	82	124	128		Swing 80 mit RIDL 9	90	89	140
	Swing 68 mit RIDL 8 II	82	67	129		Swing 80 mit RIDL 13	90	98	141
	Swing 68 mit RIDL 9	82	89	130		Swing 80 Plan mit RIDL 8 II	90	67	143
	Swing 68 mit RIDL 13	82	98	131		Swing 80 Plan mit RIDL 9	90	89	144
	Swing 68 Plan mit RIDL 8 II	82	67	133		Swing 80 Plan mit RIDL 13	90	98	145
	Swing 68 Plan mit RIDL 9	82	89	134		Twist 80 Plan RIDL 7	92	126	146
	Swing 68 Plan mit RIDL 13	82	98	135		Twist 80 Plan mit RIDL 8 II	92	69	147
	Swing 80 GU10	90	91	137		Twist 80 Plan mit RIDL 9	92	91	148
	Swing 80 RIDL 7	90	124	138		Twist 80 Plan mit RIDL 13	92	100	149
	Swing 80 mit RIDL 8 II	90	67	139		Twist 80 Square Plan RIDL 7	92x92	126	150
	Swing 80 mit RIDL 9	90	89	140		Twist 80 Square Plan mit RIDL 8 II	92x92	69	151
	Swing 80 mit RIDL 13	90	98	141		Twist 80 Square Plan mit RIDL 9	92x92	91	152
	Swing 80 Plan mit RIDL 8 II	90	67	143		Twist 80 Square Plan mit RIDL 13	92x92	100	153
	Swing 80 Plan mit RIDL 9	90	89	144		RIDL 13 Flat	92	60	160
	Swing 80 Plan mit RIDL 13	90	98	145		RIDL 9 Karda 80	92	62	165
	Swiftly LED	86	53	156		Lift LED	95	65	167
	Vario LED, schwenkbar	80	19	157		Polar LED*	92	75	323
	RIDL 9 Flat	82	50	158	<b>81 – 82</b>	RIDL 13 Flat	92	60	160
	RIDL 8 Karda 68	82	54	163		RIDL 9 Karda 80	92	62	165
	RIDL 9 Karda 68	82	62	164		Lift LED	95	65	167
	RIDL 9 Karda 80	92	62	165	<b>83 – 85</b>	Lift LED	95	65	167
	Zenta II LED	75	60	179	<b>90 – 99</b>	Twist 100 Plan mit RIDL 9	110	89	155
	Pico LED	78	95	183		EcoLED	110	70	171
	Mira II LED	75	69	185		Zenta II LED	110	88	179
<b>69 – 74</b>	Swing 80 GU10	90	91	137		Polar LED*	112	75	323
	Swing 80 RIDL 7	90	124	138	<b>100</b>	Twist 100 Plan mit RIDL 9	110	89	155
	Swing 80 mit RIDL 8 II	90	67	139		EcoLED	110	70	171
	Swing 80 mit RIDL 9	90	89	140		Zenta II LED	110	88	179
	Swing 80 mit RIDL 13	90	98	141		Mira II LED	112	100	186
	Swing 80 Plan mit RIDL 8 II	90	67	143		Polar LED*	112	75	323
	Swing 80 Plan mit RIDL 9	90	89	144	<b>108</b>	Takeo Round LED	118	35	168
	Swing 80 Plan mit RIDL 13	90	98	145	<b>115</b>	RIDL Flex Round Big II	129	120	174
	Swiftly LED	86	53	156	<b>125</b>	EcoLED	142	83	171
	RIDL 9 Karda 80	92	62	165		Zenta II LED	138	116	180
<b>75</b>	Swing 80 GU10	90	91	137		Mira II LED	138	132	186
	Swing 80 RIDL 7	90	124	138	<b>126 – 131</b>	EcoLED	142	83	171
	Swing 80 mit RIDL 8 II	90	67	139	<b>132</b>	Flatfix Superslim II	146	37	168
	Swing 80 mit RIDL 9	90	89	140		EcoLED	142	83	171
	Swing 80 mit RIDL 13	90	98	141	<b>140 – 149</b>	EcoLED	165	95	172
	Swing 80 Plan mit RIDL 8 II	90	67	143	<b>150</b>	EcoLED	165	95	172
	Swing 80 Plan mit RIDL 9	90	89	144		RIDL Concave Big II	163	144	177
	Swing 80 Plan mit RIDL 13	90	98	145		Zenta II LED	165	144	180
	Swiftly LED	86	53	156		Zenta II Tunable White LED	165	144	181
	RIDL 13 Flat	92	60	160		Mira II LED	162	153	187
	RIDL 9 Karda 80	92	62	165	<b>160</b>	Flatfix Superslim II	172	37	169
	Mira II LED	85	78	185	<b>172 – 189</b>	EcoLED	210	101	172
<b>76 – 79</b>	Swing 80 GU10	90	91	137	<b>190 – 199</b>	EcoLED	210	101	172
	Swing 80 RIDL 7	90	124	138		Zenta II LED	235	145	181
	Swing 80 mit RIDL 8 II	90	67	139	<b>200</b>	EcoLED	210	101	172
	Swing 80 mit RIDL 9	90	89	140		EcoLED	230	110	173
	Swing 80 mit RIDL 13	90	98	141		Zenta II LED	235	145	181
	Swing 80 Plan mit RIDL 8 II	90	67	143	<b>201 – 220</b>	EcoLED	230	110	173
	Swing 80 Plan mit RIDL 9	90	89	144		Zenta II LED	235	145	181
	Swing 80 Plan mit RIDL 13	90	98	145	<b>225</b>	Flatfix Superslim II	238	37	169
	RIDL 13 Flat	92	60	160	<b>2x80</b>	Twist 2X Square Plan mit RIDL 9	175x92	91	155
	RIDL 9 Karda 80	92	62	165					

---

**Einbau-Downlights**

	Name	LxB	EBT	Seite
<b>125x125</b>	RIDL Flex Square Big II	140x140	120	175
<b>164x80</b>	Twist 2X Square Plan mit RIDL 9	175x92	91	155

---

**Deckeneinbauringe**

	Name	Ø / LxB	EBT	Seite
<b>68</b>	Swing 68	82	67 – 124	200
	Swing 68 Plan	82	67 – 124	201
	Swing 80	90	67 – 124	202
	Swing 80 Plan	90	67 – 124	203
	Concave	78	75 – 132	208
	Mood Trimless	66	98 – 155	210
	Mood	80	98 – 155	211
	Disc	80	87 – 144	213
	Disc, schwenkbar	92	69 – 126	213
<b>69 – 74</b>	Swing 80	90	67 – 124	202
	Swing 80 Plan	90	67 – 124	203
<b>75</b>	Swing 80	90	67 – 124	202
	Swing 80 Plan	90	67 – 124	203
	Concave	86	77 – 134	208
<b>76 – 79</b>	Swing 80	90	67 – 124	202
	Swing 80 Plan	90	67 – 124	203
<b>80</b>	Swing 80	90	67 – 124	202
	Swing 80 Plan	90	67 – 124	203
	Twist 80 Plan	92	69 – 126	204
	Twist 80 Square Plan	92x92	69 – 126	205
	Concave	90	83 – 140	209
<b>90 – 100</b>	Twist 100 Plan	110	67 – 124	206
<b>2x80</b>	Twist 2X Square Plan	175x92	69 – 126	207



	Name	LxB	EBT	Seite
<b>164x80</b>	Twist 2X Square Plan	175x92	69 – 126	207

---

**Möbeleinbauleuchten**

	Name	Ø / LxB	EBT	Seite
<b>45</b>	Eye LED	52	32	309
<b>50</b>	Vario	60	10	310
<b>60</b>	Vario, schwenkbar	70	10	310



# Das volle Programm – für jeden Deckenausschnitt

Leuchtmittelwechsel von unten ohne Ringdemontage und einheitliche Oberflächen und Funktionalitäten über das gesamte Programm

## Die Swing Familie



Swing 68	Swing 68 Plan	Swing 80	Swing 80 Plan
Ø 68 mm		Ø 68 – 80 mm	
Ø 82 mm		Ø 90 mm	
Spannfeder oder Blattfeder			

### Formen

verschmilzt mit der Decke



Swing 68  
Swing 80

pur in seiner Form

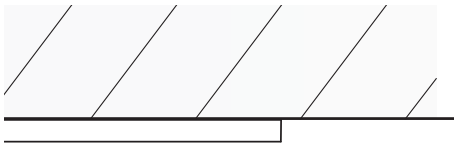

Swing 68 Plan    Twist 80 Plan    Twist 100 Plan  
Swing 80 Plan    Twist 80 Square Plan    Twist 2X Square Plan

### Farben/Finish

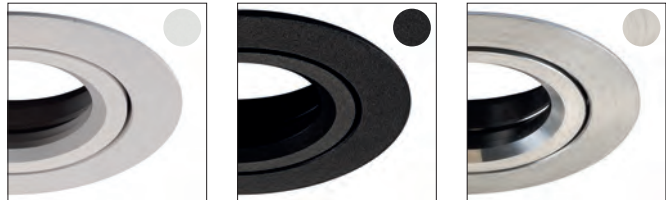

weiss, strukturiert,  
~RAL 9003

schwarz, strukturiert,  
~RAL 9004

alu-gebürstet

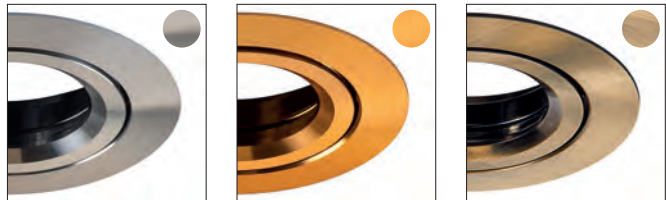



alu-glänzend

gold, eloxiert

bronze, gebürstet

## Die Twist Familie



Twist 80 Plan	Twist 80 Square Plan	Twist 100 Plan	Twist 2X Square Plan
 <b>Ø 80 mm</b>		 <b>Ø 90 – 100 mm</b>	 <b>Ø 164 x 80 mm</b>
Ø 92 mm	92 x 92 mm	Ø 110 mm	175 x 92 mm
Spannfeder oder Blattfeder		Spannfeder (Blattfeder optional)	



### Befestigungstechnik



Spannfeder



Blattfeder

### Zubehör



GU10 Fassung – schnelle Installation ohne Werkzeug



Blattfeder-Set

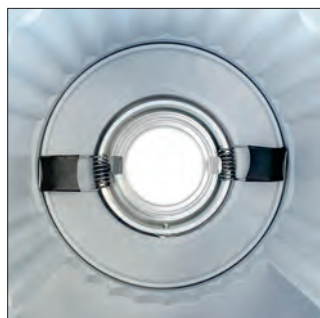

Für Agro/Kaiser-Einbetoniergehäuse sind die Spannfeder-Varianten wie geschaffen



Für einen sicheren Halt des Leuchtmittels verfügen alle Ringe über eine Haltefeder



Mit unserem neuen Sortiment an Deckeinbauringen, Leuchtmitteln und Treiber ergeben sich unzählige Kombinationsmöglichkeiten. Wir möchten Ihnen die Arbeit erleichtern und bieten Ihnen ab Seite 127 bereits 1896 solcher Kombinationen an. Entdecken Sie jetzt unser neues Einbau-Downlight Sortiment!







# Swing 68 RIDL 7 Ø 68 mm | Einbau-Downlight

CRI 90

verschmilzt mit der Decke



### Informationen

- inkl. GU10 Keramikfassung
- integriertes und berechnetes Kühlmanagement
- entblendetes Leuchtmittel
- Leuchtmittelwechsel von unten ohne Ringdemontage
- perfekt dimmbar
- homogene Lichtverteilung
- 60° schwenkbar (2 x 30°)
- Leuchtmittel gut entblendet (zurückversetzt)
- eine Haltefeder sichert das Leuchtmittel

Empfohlenes Einbetoniergehäuse von  
 AGRO AG / Kaiser: 920 858 319  
 Frontring: 920 896 209  
 Zwischenrahmen: 920 896 949

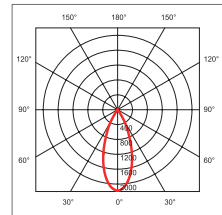
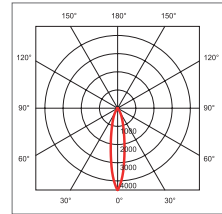
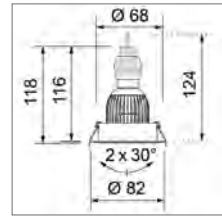

7.6 W  
 510 lm, 540 lm  
 2700 K, 3000 K  
 CRI 90  
 Abstrahlwinkel: 20°, 38°  
 40'000h L70 B10

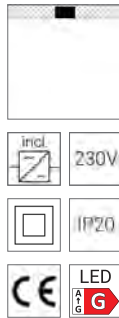

Farbe/Finish		mit Spannfedern		mit Blattfedern	
		2700 K	3000 K	2700 K	3000 K
weiss, strukturiert, ~RAL 9003	20°	UD-997-011-221	UD-997-011-721	UD-997-013-221	UD-997-013-721
	38°	UD-997-011-241	UD-997-011-741	UD-997-013-241	UD-997-013-741
schwarz, strukturiert, ~RAL 9004	20°	UD-997-011-222	UD-997-011-722	UD-997-013-222	UD-997-013-722
	38°	UD-997-011-242	UD-997-011-742	UD-997-013-242	UD-997-013-742
alu-gebürstet	20°	UD-997-011-223	UD-997-011-723	UD-997-013-223	UD-997-013-723
	38°	UD-997-011-243	UD-997-011-743	UD-997-013-243	UD-997-013-743
alu-glänzend	20°	UD-997-011-224	UD-997-011-724	UD-997-013-224	UD-997-013-724
	38°	UD-997-011-244	UD-997-011-744	UD-997-013-244	UD-997-013-744
gold, eloxiert	20°	UD-997-011-225	UD-997-011-725	UD-997-013-225	UD-997-013-725
	38°	UD-997-011-245	UD-997-011-745	UD-997-013-245	UD-997-013-745
		CHF 62.00	CHF 62.00	CHF 62.00	CHF 62.00

























# Swing 80 RIDL 7 Ø 68 – 80 mm | Einbau-Downlight

**CRI 90**

verschmilzt mit der Decke



### Informationen

- inkl. GU10 Keramikfassung
- integriertes und berechnetes Kühlmanagement
- entblendetes Leuchtmittel
- Leuchtmittelwechsel von unten ohne Ringdemontage
- perfekt dimmbar
- homogene Lichtverteilung
- 60° schwenkbar (2 x 30°)
- Leuchtmittel gut entblendet (zurückversetzt)
- eine Haltefeder sichert das Leuchtmittel

Empfohlenes Einbetoniergehäuse von  
 AGRO AG / Kaiser: 920 858 319  
 Frontring: 920 896 229  
 Zwischenrahmen: 920 896 949

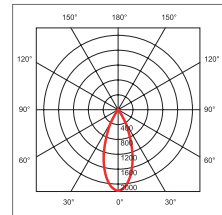
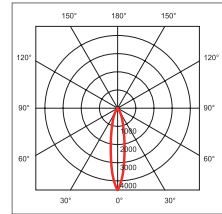
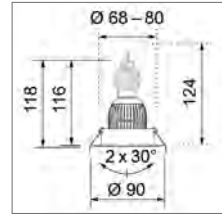

7.6 W  
 510 lm, 540 lm  
 2700 K, 3000 K  
 CRI 90  
 Abstrahlwinkel: 20°, 38°  
 40'000h L70 B10



Farbe/Finish		mit Spannfedern		mit Blattfedern	
		2700 K	3000 K	2700 K	3000 K
weiss, strukturiert, ~RAL 9003	20°	UD-997-019-221	UD-997-019-721	UD-997-021-221	UD-997-021-721
	38°	UD-997-019-241	UD-997-019-741	UD-997-021-241	UD-997-021-741
schwarz, strukturiert, ~RAL 9004	20°	UD-997-019-222	UD-997-019-722	UD-997-021-222	UD-997-021-722
	38°	UD-997-019-242	UD-997-019-742	UD-997-021-242	UD-997-021-742
alu-gebürstet	20°	UD-997-019-223	UD-997-019-723	UD-997-021-223	UD-997-021-723
	38°	UD-997-019-243	UD-997-019-743	UD-997-021-243	UD-997-021-743
alu-glänzend	20°	UD-997-019-224	UD-997-019-724	UD-997-021-224	UD-997-021-724
	38°	UD-997-019-244	UD-997-019-744	UD-997-021-244	UD-997-021-744
gold, eloxiert	20°	UD-997-019-225	UD-997-019-725	UD-997-021-225	UD-997-021-725
	38°	UD-997-019-245	UD-997-019-745	UD-997-021-245	UD-997-021-745
		CHF 64.00	CHF 64.00	CHF 64.00	CHF 64.00





















# Twist 80 Plan RIDL 7 Ø 80 mm | Einbau-Downlight

**CRI 90**

bewährtes Design in neuer Qualität



### Informationen

- inkl. GU10 Keramikfassung
- integriertes und berechnetes Kühlmanagement
- entblendetes Leuchtmittel
- Leuchtmittelwechsel von unten ohne Ringdemontage
- perfekt dimmbar
- homogene Lichtverteilung
- 60° schwenkbar (2 x 30°)
- 350° drehbar
- Leuchtmittel gut entblendet (zurückversetzt)
- eine Haltefeder sichert das Leuchtmittel

Empfohlenes Einbetoniergehäuse von  
 AGRO AG / Kaiser: 920 858 319  
 Frontring: 920 896 229  
 Zwischenrahmen: 920 896 949

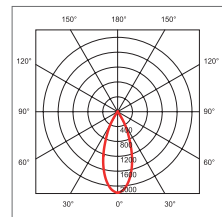
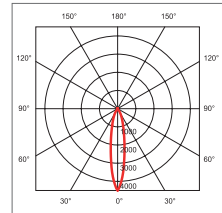
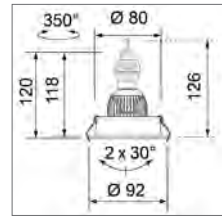

7.6 W  
 510 lm, 540 lm  
 2700 K, 3000 K  
 CRI 90  
 Abstrahlwinkel: 20°, 38°  
 40'000h L70 B10



Farbe/Finish		mit Spannfedern		mit Blattfedern	
		2700 K	3000 K	2700 K	3000 K
weiss, strukturiert, ~RAL 9003	20°	UD-997-027-221	UD-997-027-721	UD-997-029-221	UD-997-029-721
	38°	UD-997-027-241	UD-997-027-741	UD-997-029-241	UD-997-029-741
schwarz, strukturiert, ~RAL 9004	20°	UD-997-027-222	UD-997-027-722	UD-997-029-222	UD-997-029-722
	38°	UD-997-027-242	UD-997-027-742	UD-997-029-242	UD-997-029-742
alu-gebürstet	20°	UD-997-027-223	UD-997-027-723	UD-997-029-223	UD-997-029-723
	38°	UD-997-027-243	UD-997-027-743	UD-997-029-243	UD-997-029-743
		CHF 66.00	CHF 66.00	CHF 66.00	CHF 66.00









# Twist 80 Square Plan RIDL 7 Ø 80 mm | Einbau-Downlight

CRI 90

bewährtes Design in neuer Qualität



### Informationen

- inkl. GU10 Keramikfassung
- integriertes und berechnetes Kühlmanagement
- entblendetes Leuchtmittel
- Leuchtmittelwechsel von unten ohne Ringdemontage
- perfekt dimmbar
- homogene Lichtverteilung
- 60° schwenkbar (2 x 30°)
- 350° drehbar
- Leuchtmittel gut entblendet (zurückversetzt)
- eine Haltefeder sichert das Leuchtmittel

Empfohlenes Einbetoniergehäuse von  
 AGRO AG / Kaiser: 920 858 319  
 Frontring: 920 896 229  
 Zwischenrahmen: 920 896 949

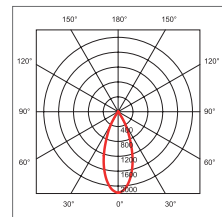
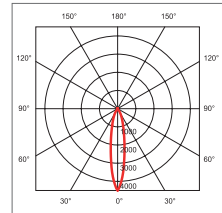
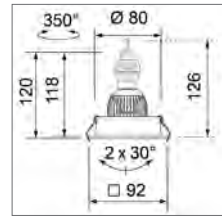

7.6 W  
 510 lm, 540 lm  
 2700 K, 3000 K  
 CRI 90  
 Abstrahlwinkel: 20°, 38°  
 40'000h L70 B10



Farbe/Finish		mit Spannfedern		mit Blattfedern	
		2700 K	3000 K	2700 K	3000 K
weiss, strukturiert, ~RAL 9003	20°	UD-997-031-221	UD-997-031-721	UD-997-033-221	UD-997-033-721
	38°	UD-997-031-241	UD-997-031-741	UD-997-033-241	UD-997-033-741
schwarz, strukturiert, ~RAL 9004	20°	UD-997-031-222	UD-997-031-722	UD-997-033-222	UD-997-033-722
	38°	UD-997-031-242	UD-997-031-742	UD-997-033-242	UD-997-033-742
alu-gebürstet	20°	UD-997-031-223	UD-997-031-723	UD-997-033-223	UD-997-033-723
	38°	UD-997-031-243	UD-997-031-743	UD-997-033-243	UD-997-033-743
		CHF 66.00	CHF 66.00	CHF 66.00	CHF 66.00









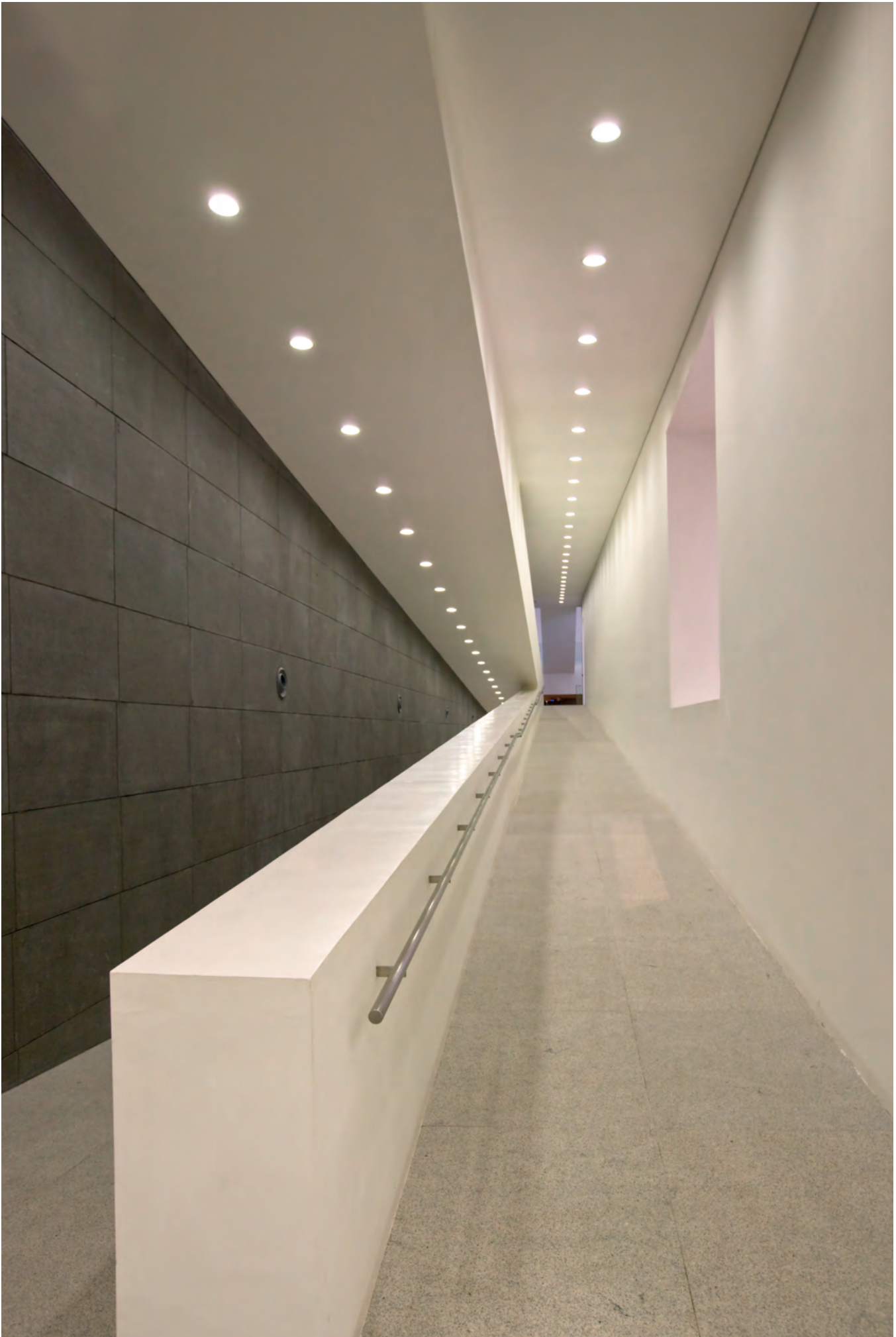

## Twist 100 Plan mit RIDL 9, Ø 90 – 100 mm | Einbau-Downlight

bewährtes Design in neuer Grösse



### Informationen

- integriertes und berechnetes Kühlmanagement
- entblendetes Leuchtmittel
- Leuchtmittelwechsel von unten ohne Ringdemontage
- mit steckbarem Anschlusskabel
- 60° schwenkbar (2 x 30°)
- Leuchtmittel gut entblendet (zurückversetzt)
- eine Haltefeder sichert das Leuchtmittel
- mit vormontierten Spannfedern
- Blattfedern als Zubehör beiliegend

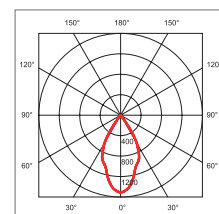
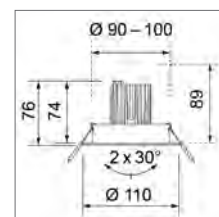

inklusive Treiber

- 043-500-12, S. 399
- 043-001-012, S. 403

Empfohlenes Einbetoniergehäuse von AGRO AG / Kaiser: 920 858 329  
Frontring: 920 896 269

- 11 W
- 770 lm
- 3000 K
- CRI 90
- Abstrahlwinkel: 60°
- 30°000h L70 B10
- 500 mA
- U<sub>F</sub> 15.5 – 18.5 V

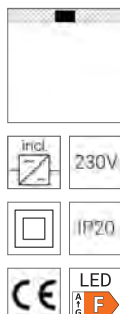

Variante	Farbe	Art.-Nr.	CHF
NEW	R/C weiss, strukturiert, ~RAL 9003	UD-999-035-761	86.00
NEW	R/C schwarz, strukturiert, ~RAL 9004	UD-999-035-762	86.00
NEW	R/C alu-gebürstet	UD-999-035-763	86.00
NEW	DALL 2 PUSH DIM weiss, strukturiert, ~RAL 9003	UD-999-036-761	112.00
NEW	DALL 2 PUSH DIM schwarz, strukturiert, ~RAL 9004	UD-999-036-762	112.00
NEW	DALL 2 PUSH DIM alu-gebürstet	UD-999-036-763	112.00

## Twist 2X Square Plan mit RIDL 9, 164 x 80 mm | Einbau-Downlight

bewährtes Design in neuer Grösse



### Informationen

- integriertes und berechnetes Kühlmanagement
- entblendetes Leuchtmittel
- Leuchtmittelwechsel von unten ohne Ringdemontage
- mit steckbarem Anschlusskabel
- 60° schwenkbar (2 x 30°)
- 350° drehbar
- Leuchtmittel gut entblendet (zurückversetzt)
- eine Haltefeder sichert das Leuchtmittel
- mit vormontierten Spannfedern

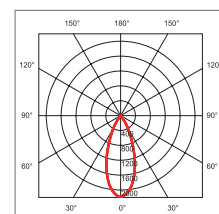
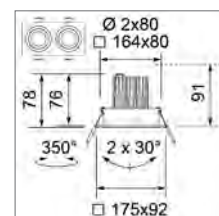

inklusive Treiber

- 2 x 043-500-12, S. 399
- 2 x 043-001-012, S. 403

Empfohlene Einbetoniergehäuse von AGRO AG / Kaiser: 920 858 399  
(nicht für Sichtbeton geeignet): 920 896 589

- 2 x 11 W
- 2 x 770 lm
- 3000 K
- CRI 90
- Abstrahlwinkel: 38°
- 30°000h L70 B10
- 500 mA
- U<sub>F</sub> 15.5 – 18.5 V

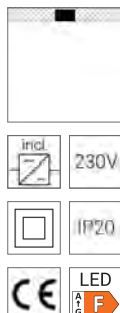

Variante	Farbe	Art.-Nr.	CHF
R/C	weiss, strukturiert, ~RAL 9003	UD-999-039-741	154.00
DALL 2 PUSH DIM	weiss, strukturiert, ~RAL 9003	UD-999-040-741	199.00

Zubehör	Art.-Nr.	CHF
NEW Frontplatte, 164 x 80 mm, für Sichtbeton	27025-003-91	auf Anfrage



## Swiftly LED Ø 68 – 75 mm | Einbau-Downlight

Alles drin



6 W

475 lm, 500 lm

2700 K, 3000 K

CRI 80

Abstrahlwinkel: 38°

30'000h L70

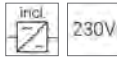

### Informationen

- Phasenabschnitt-Treiber integriert
- 30° schwenkbar (2 x 15°)
- austauschbarer Deko-Ring
- Linsenoptik
- einfache und schnelle Installation
- Deko-Ring weiss, ~RAL 9003
- Finish: matt

Empfohlenes Einbetoniergehäuse von  
AGRO AG / Kaiser: 920 858 319  
Frontring: 920 896 209

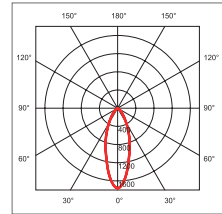
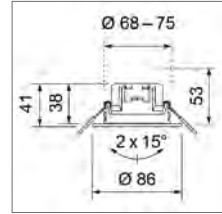

Variante	Farbtemperatur	Lichtstrom	Art.-Nr.	CHF
 r.c.	2700 K	475 lm	130-110-20	49.00
 r.c.	3000 K	500 lm	130-110-70	49.00



### Deko-Ring

Variante	Art.-Nr.	CHF
gebürstet	130-110-99	5.00



### Deko-Ring

Variante	Art.-Nr.	CHF
schwarz, matt, ~RAL 9004	130-110-98	5.00

**Vario LED**  Ø 68 mm, schwenkbar | **Einbau-Downlight**

sehr geringe Einbautiefe für Decken und Möbeleinbau

**CRI 90****Informationen**

- 20° schwenkbar
- 270° drehbar
- hoher Lichtkomfort und Wirtschaftlichkeit
- mit steckbarem Anschlusskabel

Empfohlenes Einbetoniergehäuse von

AGRO AG / Kaiser: 920 858 329

Frontring: 920 896 209

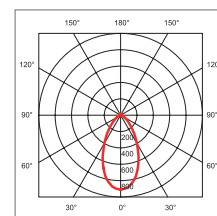
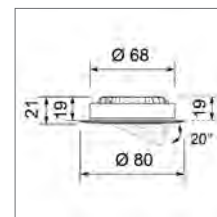

4.2 W

480 lm

3000 K

CRI 90

Abstrahlwinkel: 50°

50'000h L70

260 mA

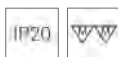
U<sub>F</sub> 15.5 – 18.5 V**Farbe/Finish**

weiss, ~RAL 9010

alu-gebürstet

schwarz, strukturiert, ~RAL 9005

**Art.-Nr.**

25817-022-73

25817-050-73



25817-057-73

**CHF**

54.00

54.00

54.00

**Empfohlene Treiber** 9 W, 260 mA 12 W, 180 – 500 mA 10 W, 260 – 350 mA, rund**Seite**

398

403

402

**Art.-Nr.**

043-260-09

043-001-012

200-018-010

**CHF**

47.00

69.00

74.00

**Vario LED**  Ø 58 mm | **Einbau-Downlight**

sehr geringe Einbautiefe für Decken und Möbeleinbau

**CRI 90****Informationen**

- IP44 von unten bei geschlossener Decke
- hoher Lichtkomfort und Wirtschaftlichkeit
- mit steckbarem Anschlusskabel

Empfohlenes Einbetoniergehäuse

(nicht für Sichtbeton geeignet)

von AGRO AG / Kaiser: 920 858 329

Frontring: 920 896 119

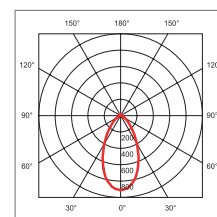
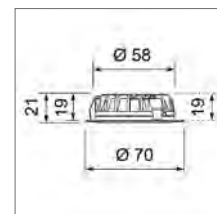

4.2 W

480 lm

3000 K

CRI 90

Abstrahlwinkel: 50°

50'000h L70

260 mA

U<sub>F</sub> 15.5 – 18.5 V**Farbe/Finish**

weiss, ~RAL 9010

alu-gebürstet

schwarz, strukturiert, ~RAL 9005

**Art.-Nr.**

25817-021-73

25817-049-73



25817-056-73

**CHF**

44.00

44.00

44.00

**Empfohlene Treiber** 9 W, 260 mA 12 W, 180 – 500 mA**Seite**

398

403

**Art.-Nr.**

043-260-09

043-001-012

**CHF**

47.00

69.00

## RIDL 9 Flat Ø 68 mm, ohne Treiber | Einbau-Downlight

geringe Einbautiefe und beste Entblendung

CRI  
90

### Informationen

- 40° schwenkbar (2 x 20°)
- mit steckbarem Anschlusskabel

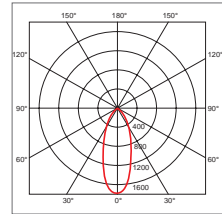
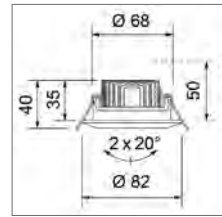

Empfohlenes Einbetoniergehäuse von  
AGRO AG / Kaiser: 920 858 329  
Frontring: 920 896 209

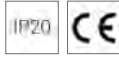
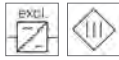

9 W  
740 lm, 770 lm  
2700 K, 3000 K  
CRI 90  
Abstrahlwinkel: 40°  
35'000h L70  
500 mA  
U<sub>e</sub> 15.5 – 18.5 V



Farbe/Finish	Farbtemperatur	Art.-Nr.	CHF
weiss, matt, ~RAL 9016	2700 K	130-940-20	74.00
weiss, matt, ~RAL 9016	3000 K	130-940-71	74.00
alu-gebürstet	2700 K	130-941-20	74.00
alu-gebürstet	3000 K	130-941-71	74.00
schwarz, matt, ~RAL 9004	2700 K	130-945-20	74.00
schwarz, matt, ~RAL 9004	3000 K	130-945-70	74.00

Empfohlene Treiber	Seite	Art.-Nr.	CHF
 12 W, 500 mA	399	043-500-12	48.00
 12 W, 180 – 500 mA	403	043-001-012	69.00
 10 W, 500 – 700 mA, rund	402	200-019-010	74.00

**RIDL 9 Flat**  Ø 68 mm | **Einbau-Downlight**

geringe Einbautiefe und beste Entblendung

**Informationen**

- 40° schwenkbar (2 x 20°)
- mit steckbarem Anschlusskabel

inklusive Treiber

 043-500-12, S. 399 043-001-012, S. 403

Empfohlenes Einbetoniergehäuse von

AGRO AG / Kaiser: 920 858 329

Frontring: 920 896 209

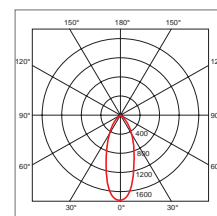
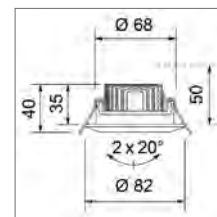

11.5 W

740 lm, 770 lm

2700 K, 3000 K

CRI 90

Abstrahlwinkel: 40°

35'000h L70

500 mA

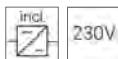
U<sub>F</sub> 15.5 – 18.5 V

Farbe/Finish	Farbtemperatur	Art.-Nr.	CHF
weiss, matt, ~RAL 9016	2700 K	UD-126-007-150	94.00
weiss, matt, ~RAL 9016	3000 K	UD-126-001-151	94.00
alu-gebürstet	2700 K	UD-126-010-150	94.00
alu-gebürstet	3000 K	UD-126-004-151	94.00
schwarz, matt, ~RAL 9004	2700 K	UD-126-013-150	94.00
schwarz, matt, ~RAL 9004	3000 K	UD-126-016-151	94.00



Farbe/Finish	Farbtemperatur	Art.-Nr.	CHF
weiss, matt, ~RAL 9016	2700 K	UD-126-009-150	119.00
weiss, matt, ~RAL 9016	3000 K	UD-126-003-151	119.00
alu-gebürstet	2700 K	UD-126-012-150	119.00
alu-gebürstet	3000 K	UD-126-006-151	119.00
schwarz, matt, ~RAL 9004	2700 K	UD-126-015-150	119.00
schwarz, matt, ~RAL 9004	3000 K	UD-126-018-151	119.00



## RIDL 13 Flat Ø 75 – 82 mm, ohne Treiber | Einbau-Downlight

geringe Einbautiefe und beste Entblendung

CRI  
90

### Informationen

- 40° schwenkbar (2 x 20°)
- mit steckbarem Anschlusskabel

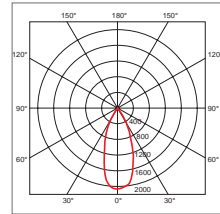
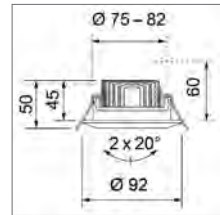

Empfohlenes Einbetoniergehäuse von  
AGRO AG / Kaiser: 920 858 329  
Frontring: 920 896 229



12 W
1130 lm, 1210 lm
2700 K, 3000 K
CRI 90
Abstrahlwinkel: 40°
35'000h L70
350 mA
U <sub>e</sub> 31 – 37 V



Farbe/Finish	Farbtemperatur	Art.-Nr.	CHF
weiss, matt, ~RAL 9016	2700 K	130-942-20	94.00
weiss, matt, ~RAL 9016	3000 K	130-942-70	94.00
alu-gebürstet	2700 K	130-943-20	94.00
alu-gebürstet	3000 K	130-943-70	94.00

Empfohlene Treiber	Seite	Art.-Nr.	CHF
 18 W, 350 mA	399	043-350-18	59.00
 25 W, 260 – 700 mA	403	043-001-025	74.00

**RIDL 13 Flat**  Ø 75 – 82 mm | **Einbau-Downlight**

geringe Einbautiefe und beste Entblendung

**Informationen**

- 40° schwenkbar (2 x 20°)
- mit steckbarem Anschlusskabel

inklusive Treiber

 043-350-18, S. 399 043-001-025, S. 403

Empfohlenes Einbetoniergehäuse von

AGRO AG / Kaiser: 920 858 329

Frontring: 920 896 229

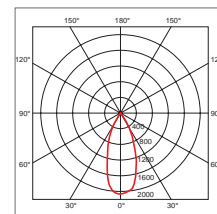
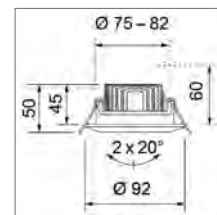

14.5 W

1130 lm, 1210 lm

2700 K, 3000 K

CRI 90

Abstrahlwinkel: 40°

35'000h L70

350 mA

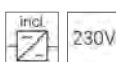
U<sub>F</sub> 31 – 37 V

Farbe/Finish	Farbtemperatur	Art.-Nr.	CHF
weiss, matt, ~RAL 9016	2700 K	UD-130-001-250	119.00
weiss, matt, ~RAL 9016	3000 K	UD-130-003-250	119.00
alu-gebürstet	2700 K	UD-130-002-193	119.00
alu-gebürstet	3000 K	UD-130-004-193	119.00



Farbe/Finish	Farbtemperatur	Art.-Nr.	CHF
weiss, matt, ~RAL 9016	2700 K	UD-130-020-250	144.00
weiss, matt, ~RAL 9016	3000 K	UD-130-023-250	144.00
alu-gebürstet	2700 K	UD-130-021-193	144.00
alu-gebürstet	3000 K	UD-130-024-193	144.00



**RIDL 8 Karda 68**  Ø 68 mm, ohne Treiber | **Einbau-Downlight**

kardanisch, praktisch, gut

**CRI 90****Informationen**

- 20° kardanisch schwenkbar
- einfache und schnelle Installation
- mit steckbarem Anschlusskabel

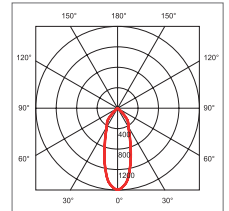
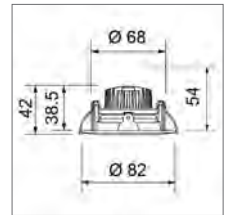

Empfohlenes Einbetoniergehäuse von  
AGRO AG / Kaiser: 920 858 329  
Frontring: 920 896 209



6.1 W  
550 lm, 580 lm  
2700 K, 3000 K  
CRI 90  
Abstrahlwinkel: 40°  
50'000h L70  
350 mA  
U<sub>F</sub> 15.5 – 18.5 V



Farbe/Finish	Farbtemperatur	Art.-Nr.	CHF
weiss, strukturiert, ~RAL 9003	2700 K	130-950-20	74.00
weiss, strukturiert, ~RAL 9003	3000 K	130-950-70	74.00
alu-gebürstet	2700 K	130-951-20	74.00
alu-gebürstet	3000 K	130-951-70	74.00
schwarz, strukturiert, ~RAL 9004	3000 K	130-952-70	74.00

Empfohlene Treiber	Seite	Art.-Nr.	CHF
 9 W, 350 mA	398	043-350-12	47.00
 12 W, 180 – 500 mA	403	043-001-012	69.00
 10 W, 260 – 350 mA, rund	402	200-018-010	74.00



**RIDL 8 Karda 68**  68 mm | **Einbau-Downlight**

kardanisch, praktisch, gut

**PUSH DIM** **CRI 90****Informationen**

- 20° kardanisch schwenkbar
- einfache und schnelle Installation
- mit steckbarem Anschlusskabel

inklusive Treiber





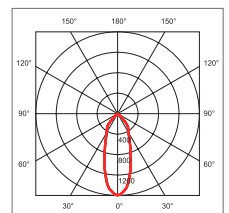
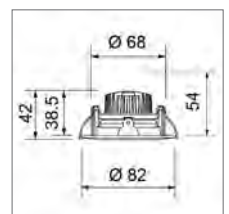



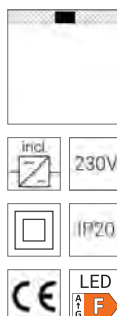

-  043-350-12, S. 398
-  043-001-012, S. 403

Empfohlenes Einbetoniergehäuse von  
AGRO AG / Kaiser: 920 858 329  
Frontring: 920 896 209



8 W  
550 lm, 580 lm  
2700 K, 3000 K  
CRI 90  
Abstrahlwinkel: 40°  
50'000h L70  
350 mA  
U<sub>F</sub> 15.5 – 18.5 V



Variante	Farbe/Finish	Farbtemp.	Art.-Nr.	CHF
	weiss, strukturiert, ~RAL 9003	2700 K	UD-130-100-020	94.00
	weiss, strukturiert, ~RAL 9003	3000 K	UD-130-100-070	94.00
	alu-gebürstet	2700 K	UD-130-102-020	94.00
	alu-gebürstet	3000 K	UD-130-102-070	94.00
	schwarz, strukturiert, ~RAL 9004	3000 K	UD-130-104-070	94.00
	weiss, strukturiert, ~RAL 9003	2700 K	UD-130-101-020	119.00
	weiss, strukturiert, ~RAL 9003	3000 K	UD-130-101-070	119.00
	alu-gebürstet	2700 K	UD-130-103-020	119.00
	alu-gebürstet	3000 K	UD-130-103-070	119.00
	schwarz, strukturiert, ~RAL 9004	3000 K	UD-130-105-070	119.00



**RIDL 9 Karda 68**  Ø 68 mm, ohne Treiber | **Einbau-Downlight****CRI 90**

kardanisch, praktisch, gut

**Informationen**

- 20° kardanisch schwenkbar
- einfache und schnelle Installation
- mit steckbarem Anschlusskabel

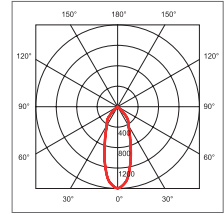
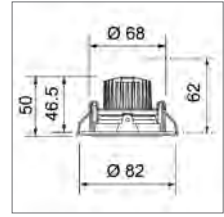

Empfohlenes Einbetoniergehäuse von  
AGRO AG / Kaiser: 920 858 329  
Frontring: 920 896 209

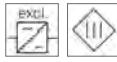

9 W
770 lm, 810 lm
2700 K, 3000 K
CRI 90
Abstrahlwinkel: 40°
50'000h L70
500 mA
U <sub>F</sub> 15.5 – 18.5 V



Farbe/Finish	Farbtemperatur	Art.-Nr.	CHF
weiss, strukturiert, ~RAL 9003	2700 K	130-955-20	79.00
weiss, strukturiert, ~RAL 9003	3000 K	130-955-70	79.00
alu-gebürstet	2700 K	130-956-20	79.00
alu-gebürstet	3000 K	130-956-70	79.00
schwarz, strukturiert, ~RAL 9004	3000 K	130-957-70	79.00

Empfohlene Treiber	Seite	Art.-Nr.	CHF
 12 W, 500 mA	399	043-500-12	48.00
 12 W, 180 – 500 mA	403	043-001-012	69.00
 10 W, 500 – 700 mA, rund	402	200-019-010	74.00



**RIDL 9 Karda 68**  Ø 68 mm | **Einbau-Downlight****CRI 90**

kardanisch, praktisch, gut

**Informationen**

- 20° kardanisch schwenkbar
- einfache und schnelle Installation
- mit steckbarem Anschlusskabel

inklusive Treiber





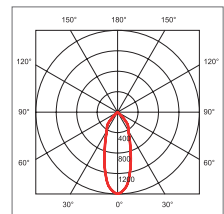
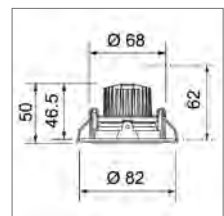



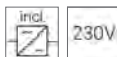

-  043-500-12, S. 399
-  043-001-012, S. 403

Empfohlenes Einbetoniergehäuse von  
AGRO AG / Kaiser: 920 858 329  
Frontring: 920 896 209



11.5 W
770 lm, 810 lm
2700 K, 3000 K
CRI 90
Abstrahlwinkel: 40°
50'000h L70
500 mA
U <sub>F</sub> 15.5 – 18.5 V



Variante	Farbe/Finish	Farbtemp.	Art.-Nr.	CHF
	weiss, strukturiert, ~RAL 9003	2700 K	UD-130-110-020	99.00
	weiss, strukturiert, ~RAL 9003	3000 K	UD-130-110-070	99.00
	alu-gebürstet	2700 K	UD-130-112-020	99.00
	alu-gebürstet	3000 K	UD-130-112-070	99.00
	schwarz, strukturiert, ~RAL 9004	3000 K	UD-130-114-070	99.00
	weiss, strukturiert, ~RAL 9003	2700 K	UD-130-111-020	124.00
	weiss, strukturiert, ~RAL 9003	3000 K	UD-130-111-070	124.00
	alu-gebürstet	2700 K	UD-130-113-020	124.00
	alu-gebürstet	3000 K	UD-130-113-070	124.00
	schwarz, strukturiert, ~RAL 9004	3000 K	UD-130-115-070	124.00

## RIDL 9 Karda 80 Ø 68 – 82 mm, ohne Treiber | Einbau-Downlight

CRI 90

kardanisch, praktisch, gut



### Informationen

- 20° kardanisch schwenkbar
- einfache und schnelle Installation
- mit steckbarem Anschlusskabel

Empfohlenes Einbetoniergehäuse von  
AGRO AG / Kaiser: 920 858 329

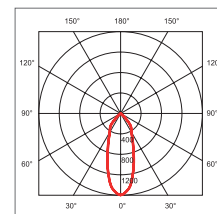
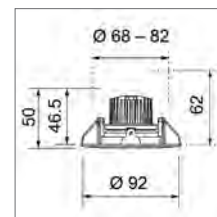

Frontring: 920 896 229



9 W
770 lm, 810 lm
2700 K, 3000 K
CRI 90
Abstrahlwinkel: 40°
50'000h L70
500 mA
U <sub>F</sub> 15.5 – 18.5 V



Farbe/Finish	Farbtemperatur	Art.-Nr.	CHF
weiss, strukturiert, ~RAL 9003	2700 K	130-960-20	84.00
weiss, strukturiert, ~RAL 9003	3000 K	130-960-70	84.00
alu-gebürstet	2700 K	130-961-20	84.00
alu-gebürstet	3000 K	130-961-70	84.00
schwarz, strukturiert, ~RAL 9004	3000 K	130-962-70	84.00

Empfohlene Treiber	Seite	Art.-Nr.	CHF
 12 W, 500 mA	399	043-500-12	48.00
 12 W, 180 – 500 mA	403	043-001-012	69.00
 10 W, 500 – 700 mA, rund	402	200-019-010	74.00

## RIDL 9 Karda 80 Ø 68 – 82 mm | Einbau-Downlight

PUSH DIM CRI 90



kardanisch, praktisch, gut



### Informationen

- 20° kardanisch schwenkbar
- einfache und schnelle Installation
- mit steckbarem Anschlusskabel

inklusive Treiber

-  043-500-12, S. 399
-  043-001-012, S. 403





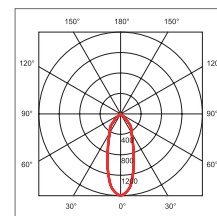
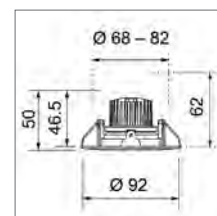



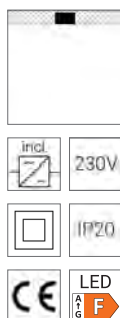

Empfohlenes Einbetoniergehäuse von  
AGRO AG / Kaiser: 920 858 329

Frontring: 920 896 229



11.5 W
770 lm, 810 lm
2700 K, 3000 K
CRI 90
Abstrahlwinkel: 40°
50'000h L70
500 mA
U <sub>F</sub> 15.5 – 18.5 V



Variante	Farbe/Finish	Farbtemp.	Art.-Nr.	CHF
	weiss, strukturiert, ~RAL 9003	2700 K	UD-130-120-020	104.00
	weiss, strukturiert, ~RAL 9003	3000 K	UD-130-120-070	104.00
	alu-gebürstet	2700 K	UD-130-122-020	104.00
	alu-gebürstet	3000 K	UD-130-122-070	104.00
	schwarz, strukturiert, ~RAL 9004	3000 K	UD-130-124-070	104.00
	weiss, strukturiert, ~RAL 9003	2700 K	UD-130-121-020	129.00
	weiss, strukturiert, ~RAL 9003	3000 K	UD-130-121-070	129.00
	alu-gebürstet	2700 K	UD-130-123-020	129.00
	alu-gebürstet	3000 K	UD-130-123-070	129.00
	schwarz, strukturiert, ~RAL 9004	3000 K	UD-130-125-070	129.00



**Lift LED**  Ø 80 – 85 mm, ohne Treiber | **Einbau-Downlight**

zurückversetzt für ein ruhiges Deckenbild

**CRI 90**



**Informationen**

- variabel zurück versetzbares Downlight
- 40° schwenkbar (2 x 20°)
- sehr geringe Einbautiefe
- Farbe: weiss, ~RAL 9016
- Finish: strukturiert
- mit steckbarem Anschlusskabel

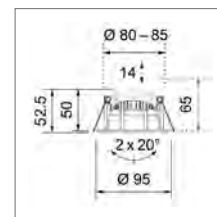



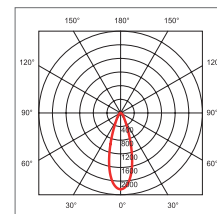

Empfohlenes Einbetoniergehäuse von  
AGRO AG / Kaiser: 920 858 329  
Frontring: 920 896 229



6.1 W
510 lm, 540 lm
2700 K, 3000 K
CRI 90
Abstrahlwinkel: 36°
50'000h L70
350 mA
U <sub>F</sub> 15.5 – 18.5 V



Farbtemperatur	Lichtstrom	Art.-Nr.	CHF
2700 K	510 lm	130-202-20	89.00
3000 K	540 lm	130-202-70	89.00

Empfohlene Treiber	Seite	Art.-Nr.	CHF
 20 W, 350 mA	396	043-350-20	40.00
 9 W, 350 mA	398	043-350-12	47.00
 12 W, 180 – 500 mA	403	043-001-012	69.00
 10 W, 260 – 350 mA, rund	402	200-018-010	74.00

**Lift LED**  Ø 80 – 85 mm | **Einbau-Downlight**

zurückversetzt für ein ruhiges Deckenbild



**PUSH DIM** **CRI 90** **NEW**

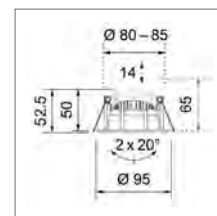

**Informationen**

- variabel zurück versetzbares Downlight
- 40° schwenkbar (2 x 20°)
- sehr geringe Einbautiefe
- Farbe: weiss, ~RAL 9016
- Finish: strukturiert
- mit steckbarem Anschlusskabel



inklusive Treiber  
 043-350-12, S. 398  
 200-018-010, S. 402

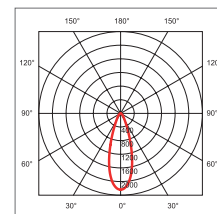

Empfohlenes Einbetoniergehäuse von  
AGRO AG / Kaiser: 920 858 329  
Frontring: 920 896 229

7.4 W, 7.6 W
510 lm, 540 lm
2700 K, 3000 K
CRI 90
Abstrahlwinkel: 36°
50'000h L70
350 mA
U <sub>F</sub> 15.5 – 18.5 V



Variante	Leistung	Lichtstrom	Farbtemperatur	Art.-Nr.	CHF
 7.6 W	7.6 W	510 lm	2700 K	UD-130-400-020	109.00
 7.6 W	7.6 W	540 lm	3000 K	UD-130-400-070	109.00
 7.4 W	7.4 W	510 lm	2700 K	UD-130-401-020	134.00
 7.4 W	7.4 W	540 lm	3000 K	UD-130-401-070	134.00



## Takeo Round LED Ø 108 mm | Einbau-Downlight

flach und rund

NEW



### Informationen

- sehr geringe Einbautiefe
- homogenes Licht
- Farbe: weiss

passend zu  
Decken- und Wandaufbauleuchte  
Takeo Round LED, S. 220

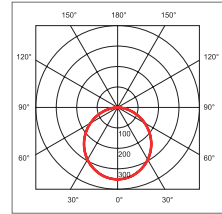
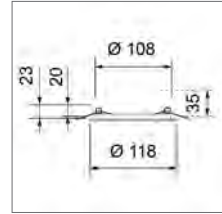

7 W
550 lm
3000 K
CRI 80
Abstrahlwinkel: 110°
50'000h L70
500 mA
U <sub>F</sub> 11 – 13 V

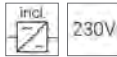



### Variante



### Art.-Nr.

### CHF

	23943-016-71	149.00
	23943-033-72	• 254.00

## Flatfix Superslim II Ø 132 mm | Einbau-Downlight



### Informationen

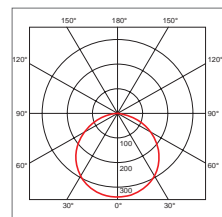
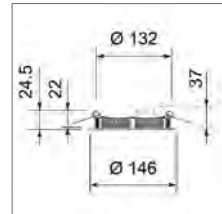

- sehr geringe Einbautiefe
- einfache Montage
- integriertes und berechnetes Kühlmanagement
- Leuchte aus Aluminium
- Farbe: weiss, ~RAL 9016
- 1-10V auf Anfrage



7 W
430 lm, 480 lm
3000 K, 4000 K
CRI 80
Abstrahlwinkel: 110°
50'000h L70
350 mA
U <sub>F</sub> 14 – 17 V



Farbtemperatur	Lichtstrom	Art.-Nr.	CHF
3000 K	430 lm	130-001-70	89.00
4000 K	480 lm	130-001-40	89.00

Empfohlene Treiber	Seite	Art.-Nr.	CHF
 20 W, 350 mA	396	043-350-20	40.00
 10 W, 260 – 350 mA, rund	402	200-018-010	74.00

## Flatfix Superslim II Ø 160 mm | Einbau-Downlight



10 W  
670 lm, 760 lm  
3000 K, 4000 K  
CRI 80  
Abstrahlwinkel: 110°  
50'000h L70  
500 mA  
U<sub>F</sub> 14 – 17 V

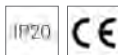

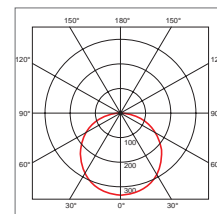
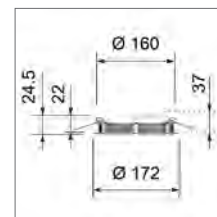

### Informationen

- sehr geringe Einbautiefe
- einfache Montage
- integriertes und berechnetes Kühlmanagement
- Leuchte aus Aluminium
- Farbe: weiss, ~RAL 9016
- 1-10V auf Anfrage



Farbtemperatur	Lichtstrom	EEK	Art.-Nr.	CHF
3000 K	670 lm	F	130-002-70	109.00
4000 K	760 lm	E	130-002-40	109.00

Empfohlene Treiber	Seite	Art.-Nr.	CHF
 20 W, 500 mA	396	043-500-20	40.00
 10 W, 500 – 700 mA, round	402	200-019-010	74.00

## Flatfix Superslim II Ø 225 mm | Einbau-Downlight



15 W  
1100 lm, 1320 lm  
3000 K, 4000 K  
CRI 80  
Abstrahlwinkel: 110°  
50'000h L70  
700 mA  
U<sub>F</sub> 17 – 20 V

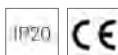

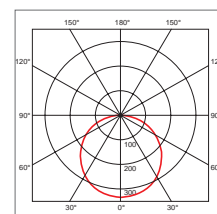
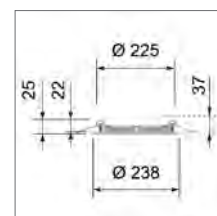

### Informationen

- sehr geringe Einbautiefe
- einfache Montage
- integriertes und berechnetes Kühlmanagement
- Leuchte aus Aluminium
- Farbe: weiss, ~RAL 9016
- 1-10V auf Anfrage



Farbtemperatur	Lichtstrom	EEK	Art.-Nr.	CHF
3000 K	1100 lm	F	130-003-70	129.00
4000 K	1320 lm	E	130-003-40	129.00

Empfohlene Treiber	Seite	Art.-Nr.	CHF
 20 W, 700 mA	396	043-700-20	40.00
 60 W, 350 – 1050 mA	406	556-050-50	129.00





## EcoLED Ø 90 – 100 mm | Einbau-Downlight

variables Lumenpaket, effizient und installationsfreundlich



5 W, 7 W  
 650 – 920 lm  
 3000 K, 4000 K  
 CRI 80  
 Abstrahlwinkel: 80°  
 50'000h L80  
 350 mA, 500 mA  
 U<sub>F</sub> 13 – 15 V

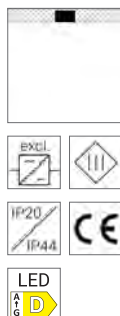

### Informationen

- mit abnehmbarem Frontring (lackierbar) zum Einklicken
- geringe Einbautiefe
- IP44 von unten bei geschlossener Decke
- hohe Lichtausbeute mit mehr als 100 lm/W
- Farbe: weiss, ~RAL9010
- Multikonstantstrom-Betrieb

Empfohlenes Einbetoniergehäuse von  
 AGRO AG / Kaiser: 920 858 359  
 Frontring: 920 896 409

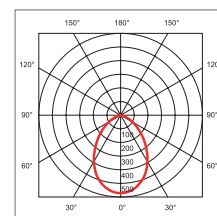
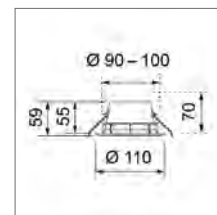

Farbtemperatur	5 W, 350 mA	7 W, 500 mA	Art.-Nr.	CHF
3000 K	650 lm	900 lm	25817-034-71	74.00
4000 K	670 lm	920 lm	25817-034-41	74.00

Empfohlene Treiber	Seite	Art.-Nr.	CHF
20 W, 350 mA	396	043-350-20	40.00
20 W, 500 mA	396	043-500-20	40.00
9 W, 350 mA	398	043-350-12	47.00
12 W, 500 mA	399	043-500-12	48.00
10 W, 260 – 350 mA, rund	402	200-018-010	74.00
10 W, 500 – 700 mA, rund	402	200-019-010	74.00

## EcoLED Ø 125 – 132 mm | Einbau-Downlight

variables Lumenpaket, effizient und installationsfreundlich



7 W, 9.5 W  
 920 – 1330 lm  
 3000 K, 4000 K  
 CRI 80  
 Abstrahlwinkel: 80°  
 50'000h L80  
 350 mA, 500 mA  
 U<sub>F</sub> 18 – 20 V



### Informationen

- idealer Ersatz für Leuchtstofflampen (350 mA: 2 x 13 W CFL)
- IP44 von unten bei geschlossener Decke
- hohe Lichtausbeute mit mehr als 100 lm/W
- Farbe: weiss, ~RAL9010
- Multikonstantstrom-Betrieb

Empfohlenes Einbetoniergehäuse von  
 AGRO AG / Kaiser: 920 858 359  
 Frontring: 920 896 429

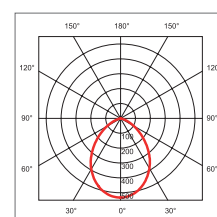
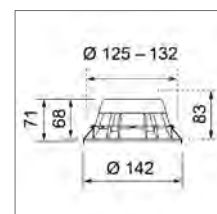

Farbtemperatur	7 W, 350 mA	9.5 W, 500 mA	Art.-Nr.	CHF
3000 K	920 lm	1300 lm	25817-027-71	94.00
4000 K	950 lm	1330 lm	25817-027-41	94.00

Empfohlene Treiber	Seite	Art.-Nr.	CHF
20 W, 350 mA	396	043-350-20	40.00
20 W, 500 mA	396	043-500-20	40.00
9 W, 350 mA	398	043-350-12	47.00
12 W, 500 mA	399	043-500-12	48.00
12 W, 180 – 500 mA	403	043-001-012	69.00
10 W, 260 – 350 mA, rund	402	200-018-010	74.00
10 W, 500 – 700 mA, rund	402	200-019-010	74.00



## EcoLED Ø 140 – 150 mm | Einbau-Downlight

variables Lumenpaket, effizient und installationsfreundlich



7 W, 9.5 W
920 – 1330 lm
3000 K, 4000 K
CRI 80
Abstrahlwinkel: 80°
50'000h L80
350 mA, 500 mA
U <sub>F</sub> 18 – 20 V



### Informationen

- idealer Ersatz für Leuchtstofflampen (350 mA: 2 x 13 W CFL)
- IP44 von unten bei geschlossener Decke
- hohe Lichtausbeute mit mehr als 100 lm/W
- Farbe: weiss, ~RAL9010
- Multikonstantstrom-Betrieb

Empfohlenes Einbetoniergehäuse von  
AGRO AG / Kaiser: 920 858 359  
Frontring: 920 896 439

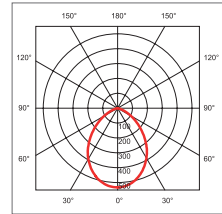
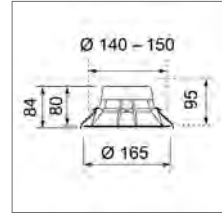

Farbtemperatur	7 W, 350 mA	9.5 W, 500 mA	Art.-Nr.	CHF
3000 K	920 lm	1300 lm	25817-058-71	99.00
4000 K	950 lm	1330 lm	25817-058-41	99.00

Empfohlene Treiber	Seite	Art.-Nr.	CHF
20 W, 350 mA	396	043-350-20	40.00
20 W, 500 mA	396	043-500-20	40.00
9 W, 350 mA	398	043-350-12	47.00
12 W, 500 mA	399	043-500-12	48.00
12 W, 180 – 500 mA	403	043-001-012	69.00
10 W, 260 – 350 mA, rund	402	200-018-010	74.00
10 W, 500 – 700 mA, rund	402	200-019-010	74.00

## EcoLED Ø 172 – 200 mm | Einbau-Downlight

variables Lumenpaket, effizient und installationsfreundlich



12 W, 17.5 W, 24.5 W
1600 – 2850 lm
3000 K, 4000 K
CRI 80
Abstrahlwinkel: 80°
50'000h L80
350 mA, 500 mA, 700 mA
U <sub>F</sub> 33 – 35 V

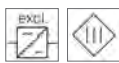

### Informationen

- idealer Ersatz für Leuchtstofflampen (350 mA: 2 x 13 W CFL / 500 mA: 2 x 18 W CFL / 700 mA: 2 x 26 W CFL)
- IP44 von unten bei geschlossener Decke
- hohe Lichtausbeute mit mehr als 100 lm/W
- Farbe: weiss, ~RAL9010
- Multikonstantstrom-Betrieb

Empfohlenes Einbetoniergehäuse von  
AGRO AG / Kaiser: 920 858 399  
Frontring: 920 896 609

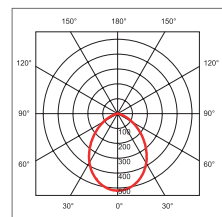
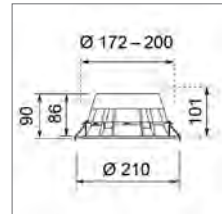

Farbtemp.	12 W, 350 mA	17.5 W, 500 mA	24.5 W, 700 mA	Art.-Nr.	CHF
3000 K	1600 lm	2200 lm	2800 lm	25817-028-71	109.00
4000 K	1650 lm	2230 lm	2850 lm	25817-028-41	109.00

Empfohlene Treiber	Seite	Art.-Nr.	CHF
20 W, 350 mA	396	043-350-20	40.00
20 W, 500 mA	396	043-500-20	40.00
40 W, 700 mA	396	043-700-42	54.00
40 W, 700 mA	400	200-006-002	64.00
45 W, 350 – 1050 mA	404	043-001-045	109.00

**EcoLED**  Ø 200 – 220 mm | **Einbau-Downlight**

variables Lumenpaket, effizient und installationsfreundlich



12 W, 17.5 W, 24.5 W

1600 – 2850 lm

3000 K, 4000 K

CRI 80

Abstrahlwinkel: 80°

50'000h L80

350 mA, 500 mA, 700 mA

U<sub>F</sub> 33 – 35 V**Informationen**

- idealer Ersatz für Leuchtstofflampen  
(350 mA: 2 x 13 W CFL / 500 mA: 2 x 18 W CFL /  
700 mA: 2 x 26 W CFL)
- IP44 von unten bei geschlossener Decke
- hohe Lichtausbeute mit mehr als 100 lm/W
- Farbe: weiss, ~RAL9010
- Multikonstantstrom-Betrieb



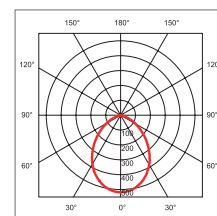
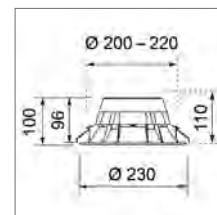

Empfohlenes Einbetoniergehäuse von

AGRO AG / Kaiser: 920 858 399

Frontring: 920 896 629



Farbtemp.	12 W, 350 mA	17.5 W, 500 mA	24.5 W, 700 mA	Art.-Nr.	CHF
3000 K	1600 lm	2200 lm	2800 lm	25817-029-71	119.00
4000 K	1650 lm	2230 lm	2850 lm	25817-029-41	119.00

Empfohlene Treiber	Seite	Art.-Nr.	CHF
 20 W, 350 mA	396	043-350-20	40.00
 20 W, 500 mA	396	043-500-20	40.00
 40 W, 700 mA	396	043-700-42	54.00
 40 W, 700 mA	400	200-006-002	64.00
 45 W, 350 – 1050 mA	404	043-001-045	109.00

## RIDL Flex Round Big II Ø 115 mm | Einbau-Downlight

höchste Farbsättigung für ihre Produkte



GAI  
100

CRI  
95

NEW



### Informationen

- 20° kardanisch schwenkbar
- ideale Shop-Beleuchtung
- CRI 95 / GAI 100 für beste Farbsättigung
- idealer Ersatz für Leuchtstofflampen (2 x 18 W CFL)
- 4000 K auf Anfrage
- Farbe: weiss, ~RAL9016
- Finish: matt

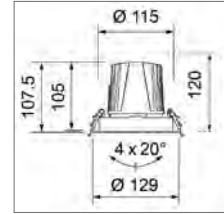

inklusive Treiber



26 W: 200-006-002, S. 400



35 W: 200-007-001, S. 400



26.7 W: 043-001-025, S. 403



34.5 W: 043-001-045, S. 404

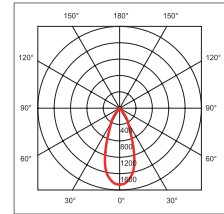

26 W – 35 W  
2400 lm, 3000 lm  
3000 K  
CRI 95, GAI 100  
Abstrahlwinkel 40°  
50'000h L70  
700 mA, 900 mA  
U<sub>e</sub> 32 – 36 V

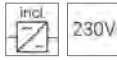

Empfohlenes Einbetoniergehäuse  
(nicht für Sichtbeton geeignet)  
von AGRO AG / Kaiser: 920 858 399  
Frontring: 920 896 589  
Zwischenrahmen: 920 896 689  
Wandeinbausatz: 920 879 529

Variante	Leistung	Lichtstrom	Farbtemperatur	Art.-Nr.	CHF
R.C.	26 W	2400 lm	3000 K	UD-130-341-071	249.00
R.C.	35 W	3000 lm	3000 K	UD-130-342-071	259.00
DALI 2	26.7 W	2400 lm	3000 K	UD-130-343-071	259.00
DALI 2	34.5 W	3000 lm	3000 K	UD-130-343-171	299.00

Zubehör	Art.-Nr.	CHF
Frontplatte, Ø 115 mm, für Sichtbeton	27025-003-96	auf Anfrage
Schutzglas, Ø 79 mm, klar	130-340-95	12.90
Reflektor, 24°	130-340-93	22.00
Reflektor, 60°	130-340-94	22.00

## RIDL Flex Square Big II 125 mm | Einbau-Downlight

höchste Farbsättigung für ihre Produkte



GAI  
100

CRI  
95

NEW





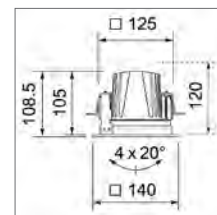

### Informationen

- 20° kardanis schwenkbar
- ideale Shop-Beleuchtung
- CRI 95 / GAI 100 für beste Farbsättigung
- idealer Ersatz für Leuchtstofflampen (2 x 18 W CFL)
- 4000 K auf Anfrage
- Farbe: weiss, ~RAL9016
- Finish: matt



inklusive Treiber

-  26 W: 200-006-002, S. 400
-  35 W: 200-007-001, S. 400
-  26.7 W: 043-001-025, S. 403
-  34.5 W: 043-001-045, S. 404

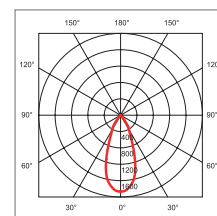

26 W – 35 W

2400 lm, 3000 lm

3000 K

CRI 95, GAI 100

Abstrahlwinkel 40°

50'000h L70

700 mA, 900 mA

U<sub>F</sub> 32 – 36 V

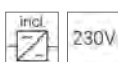

Empfohlenes Einbetoniergehäuse  
(nicht für Sichtbeton geeignet)  
von AGRO AG / Kaiser: 920 858 399  
Frontring: 920 896 589  
Zwischenrahmen: 920 896 689  
Wandeinbausatz: 920 879 529

Variante	Leistung	Lichtstrom	Farbtemperatur	Art.-Nr.	CHF
	26 W	2400 lm	3000 K	UD-130-344-071	249.00
	35 W	3000 lm	3000 K	UD-130-345-071	259.00
	26.7 W	2400 lm	3000 K	UD-130-346-071	259.00
	34.5 W	3000 lm	3000 K	UD-130-346-171	299.00

Zubehör	Art.-Nr.	CHF
Frontplatte, 125 x 125 mm, für Sichtbeton	27025-003-97	auf Anfrage
Schutzglas, Ø 79 mm, klar	130-340-95	12.90
Reflektor, 24°	130-340-93	22.00
Reflektor, 60°	130-340-94	22.00





**RIDL Concave Big II**  Ø 150 mm | **Einbau-Downlight**

höchste Farbsättigung für ihre Produkte

GAI  
100CRI  
95



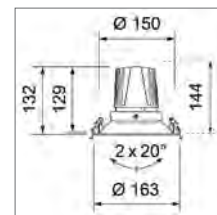

NEW

**Informationen**

- 40° schwenkbar (2 x 20°)
- ideale Shop-Beleuchtung
- CRI 95 / GAI 100 für beste Farbsättigung
- idealer Ersatz für Leuchtstofflampen (2 x 18 W CFL)
- 4000 K auf Anfrage
- Farbe: weiss, ~RAL9016
- Finish: matt



## inklusive Treiber

-  26 W: 200-006-002, S. 400
-  35 W: 200-007-001, S. 400
-  26.7 W: 043-001-025, S. 403
-  34.5 W: 043-001-045, S. 404

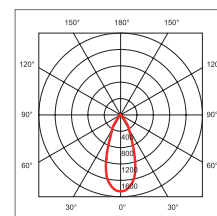

26 W – 35 W  
2400 lm, 3000 lm  
3000 K  
CRI 95, GAI 100  
Abstrahlwinkel 40°  
50'000h L70  
700 mA, 900 mA  
U<sub>F</sub> 32 – 36 V



Empfohlenes Einbetoniergehäuse  
(nicht für Sichtbeton geeignet)  
von AGRO AG / Kaiser: 920 858 399  
Frontring: 920 896 589  
Zwischenrahmen: 920 896 699  
Wandeinbausatz: 920 879 539

Variante	Leistung	Lichtstrom	Farbtemperatur	Art.-Nr.	CHF
	26 W	2400 lm	3000 K	UD-130-347-071	249.00
	35 W	3000 lm	3000 K	UD-130-348-071	259.00
	26.7 W	2400 lm	3000 K	UD-130-349-071	259.00
	34.5 W	3000 lm	3000 K	UD-130-349-171	299.00

Zubehör	Art.-Nr	CHF
Frontplatte, Ø 150 mm, für Sichtbeton	27025-003-94	auf Anfrage
Schutzglas, Ø 79 mm, klar	130-340-95	12.90
Reflektor, 24°	130-340-93	22.00
Reflektor, 60°	130-340-94	22.00

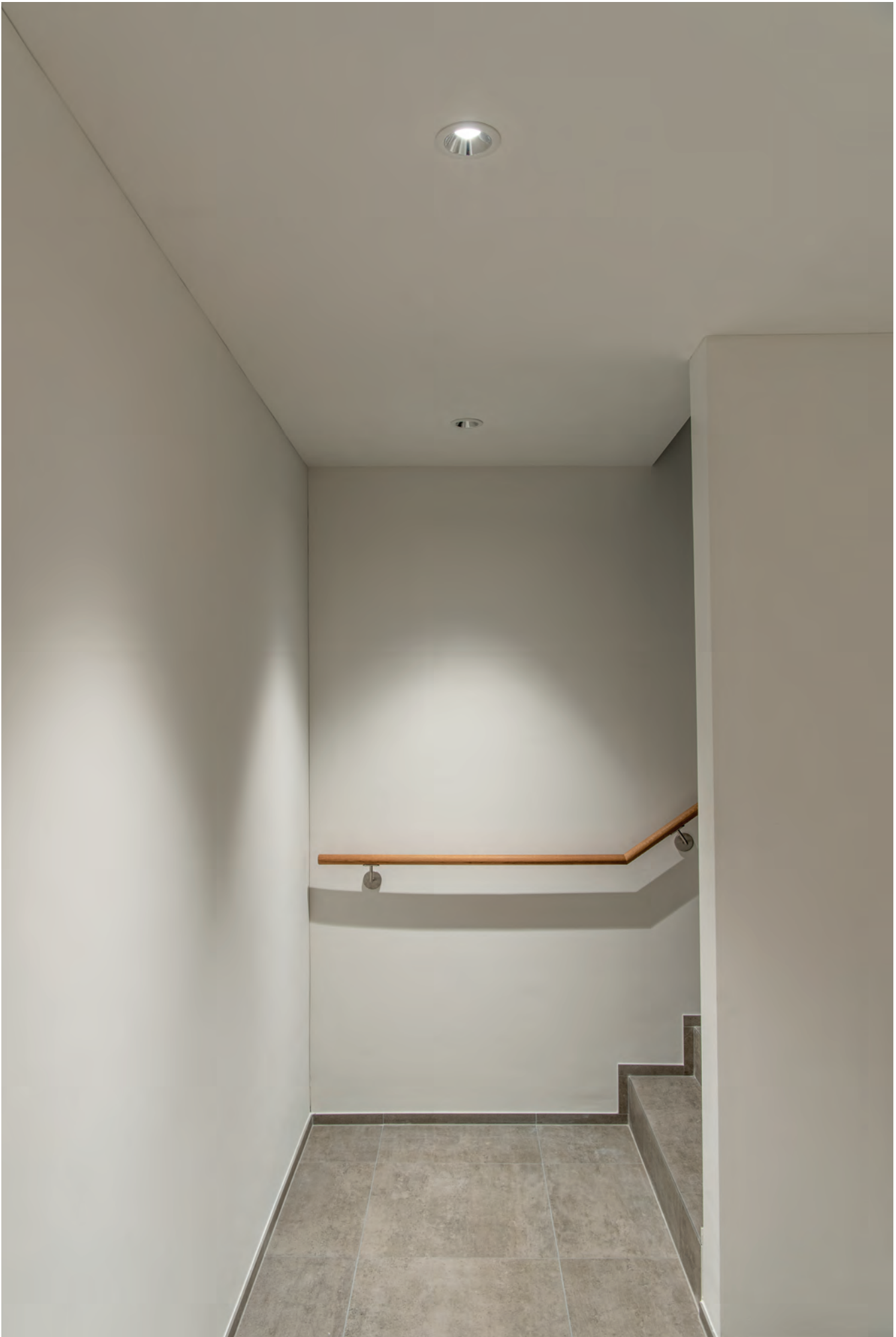

**Zenta II LED**  Ø 68 mm | **Einbau-Downlight**

entblendet, effizient, schön

UGR  
< 19CRI  
90**Informationen**

- hochwertige und entblendete Aluminium-reflektortechnik
- IP44 von unten bei geschlossener Decke
- UGR <19
- Farbe: weiss, ~RAL 9003
- Finish: strukturiert

Empfohlenes Einbetoniergehäuse von  
AGRO AG / Kaiser: 920 858 329  
Frontring: 920 896 209

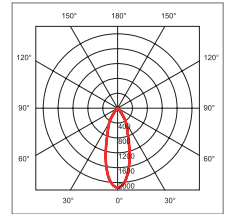
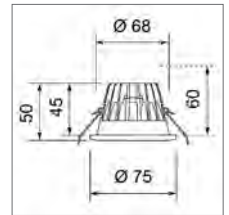

6 W

500 lm, 510 lm, 540 lm

2700 K, 3000 K, 4000 K

CRI 90





Abstrahlwinkel: 36°

50'000h L70

350 mA

U<sub>F</sub> 16 – 18 V

Farbtemperatur	Lichtstrom	Art.-Nr.	CHF
2700 K	500 lm	25817-065-20	84.00
3000 K	510 lm	25817-065-70	84.00
4000 K	540 lm	25817-065-40	84.00

Empfohlene Treiber	Seite	Art.-Nr.	CHF
 20 W, 350 mA	396	043-350-20	40.00
 9 W, 350 mA	398	043-350-12	47.00
 12 W, 180 – 500 mA	403	043-001-012	69.00
 10 W, 260 – 350 mA, rund	402	200-018-010	74.00

**Zenta II LED**  Ø 90 mm | **Einbau-Downlight**

entblendet, effizient, schön

UGR  
< 19CRI  
90**Informationen**

- hochwertige und entblendete Aluminium-reflektortechnik
- IP44 von unten bei geschlossener Decke
- UGR <19
- Farbe: weiss, ~RAL 9003
- Finish: strukturiert

Empfohlenes Einbetoniergehäuse von  
AGRO AG / Kaiser: 920 858 359  
Frontring: 920 896 409

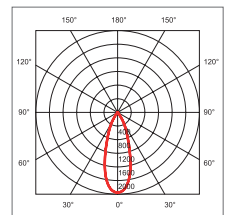
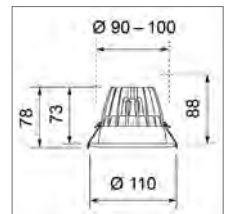

13 W

1080 lm, 1180 lm

3000 K, 4000 K

CRI 90



Abstrahlwinkel: 36°

50'000h L70

350 mA

U<sub>F</sub> 35 – 38 V

Farbtemperatur	Lichtstrom	Art.-Nr.	CHF
3000 K	1080 lm	25817-066-70	109.00
4000 K	1180 lm	25817-066-40	109.00

Empfohlene Treiber	Seite	Art.-Nr.	CHF
 20 W, 350 mA	396	043-350-20	40.00
 18 W, 350 mA	399	043-350-18	59.00
 25 W, 260 – 700 mA	403	043-001-025	74.00

Zubehör	Art.-Nr.	CHF
Reflektor, 50°	25817-041-97	19.00



## Zenta II LED Ø 125 mm | Einbau-Downlight

entblendet, effizient, schön

UGR  
< 19

CRI  
90



### Informationen

- hochwertige und entblendete Aluminium-reflektortechnik
- IP44 von unten bei geschlossener Decke
- UGR <19
- Farbe: weiss, ~RAL 9003
- Finish: strukturiert

Empfohlenes Einbetoniergehäuse  
(nicht für Sichtbeton geeignet)  
von AGRO AG / Kaiser: 920 858 399  
Frontring: 920 896 589

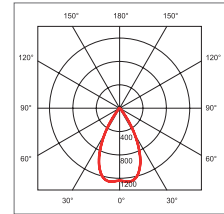
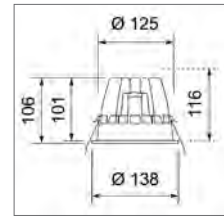

17.5 W, 25 W

1600 – 2270 lm

3000 K, 4000 K

CRI 90

Abstrahlwinkel: 50°



50'000h L70

500 mA, 700 mA

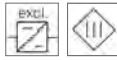
U<sub>F</sub> 35 – 38 V



Farbtemperatur	17.5 W, 500 mA	25 W, 700 mA	EEK	Art.-Nr.	CHF
3000 K	1600 lm	2000 lm	F	25817-067-70	159.00
4000 K	1700 lm	2270 lm	E	25817-067-40	159.00

Empfohlene Treiber	Seite	Art.-Nr.	CHF
 20 W, 500 mA	396	043-500-20	40.00
 40 W, 700 mA	396	043-700-42	54.00
 25 W, 260 – 700 mA	403	043-001-025	74.00

## Zenta II LED Ø 150 mm | Einbau-Downlight

entblendet, effizient, schön

UGR  
< 19

CRI  
90



### Informationen

- hochwertige und entblendete Aluminium-reflektortechnik
- IP44 von unten bei geschlossener Decke
- UGR <19
- Farbe: weiss, ~RAL 9003
- Finish: strukturiert

Empfohlenes Einbetoniergehäuse  
(nicht für Sichtbeton geeignet)  
von AGRO AG / Kaiser: 920 858 399  
Frontring: 920 896 589  
Zwischenrahmen: 920 896 699  
Wandeinbausatz: 920 879 539

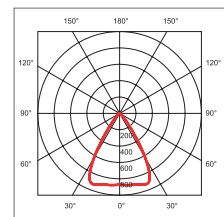
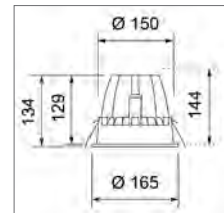

34 W

2800 lm, 3000 lm

3000 K, 4000 K

CRI 90

Abstrahlwinkel: 70°



50'000h L70

900 mA

U<sub>F</sub> 35 – 38 V



Farbtemperatur	Lichtstrom	EEK	Art.-Nr.	CHF
3000 K	2800 lm	F	25817-068-70	189.00
4000 K	3000 lm	E	25817-068-40	189.00

Empfohlene Treiber	Seite	Art.-Nr.	CHF
 40 W, 900 mA	396	043-900-42	64.00
 45 W, 350 – 1050 mA	404	043-001-045	109.00

Zubehör	Art.-Nr.	CHF
Frontplatte, Ø 150 mm, für Sichtbeton	27025-003-94	auf Anfrage

**Zenta II LED**  Ø 190 – 220 mm | **Einbau-Downlight**

entblendet, effizient, schön

**UGR**  
**< 19****CRI**  
**90****Informationen**

- hochwertige und entblendete Aluminium-reflektortechnik
- IP44 von unten bei geschlossener Decke
- UGR <19
- Farbe: weiss, ~RAL 9003
- Finish: strukturiert

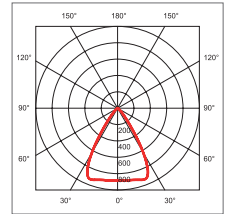
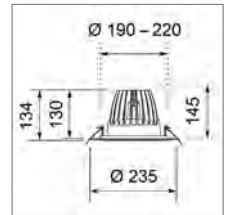

Empfohlenes Einbetoniergehäuse von  
AGRO AG / Kaiser: 920 858 399  
Frontring: 920 896 629  
Zwischenrahmen: 920 896 699  
Wandeinbausatz: 920 879 539

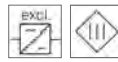

34 W
2800 lm, 3000 lm
3000 K, 4000 K
CRI 90
Abstrahlwinkel: 70°
50'000h L70
900 mA
U <sub>F</sub> 35 – 38 V



Farbtemperatur	Lichtstrom	EEK	Art.-Nr.	CHF
3000 K	2800 lm	F	130-350-70	• 249.00
4000 K	3000 lm	E	130-350-40	• 249.00

Empfohlene Treiber	Seite	Art.-Nr.	CHF
 40 W, 900 mA	396	043-900-42	64.00
 45 W, 350 – 1050 mA	404	043-001-045	109.00

**Zenta II Tunable White LED**  Ø 150 mm | **Einbau-Downlight**

dynamische Farbtemperatur

**UGR**  
**< 19****CRI**  
**90****Informationen**

- stufenlos regulierbare Farbtemperatur von Kalt- bis Warmweiss
- hochwertige und entblendete Aluminium-reflektortechnik
- IP44 von unten bei geschlossener Decke
- UGR <19
- max. 900 mA kombiniert auf 2 Eingänge
- Farbe: weiss, ~RAL 9003
- Finish: strukturiert

Empfohlenes Einbetoniergehäuse (nicht für Sichtbeton geeignet) von AGRO AG / Kaiser: 920 858 399  
Frontring: 920 896 589 / Zwischenrahmen: 920 896 699  
Wandeinbausatz: 920 879 539

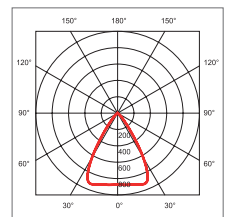
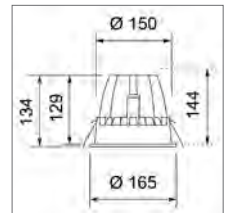

32 W
2400–2700 lm
2700–6500 K
CRI 90
Abstrahlwinkel: 70°
50'000h L70
900 mA
U <sub>F</sub> 31 – 38 V



Variante	Art.-Nr.	CHF
	25817-070-70	244.00

Empfohlene Treiber	Seite	Art.-Nr.	CHF
 50 W, 250 – 1500 mA, DT8, TW	405	25716-024-99	159.50

Zubehör	Art.-Nr.	CHF
Frontplatte, Ø 150 mm, für Sichtbeton	27025-003-94	auf Anfrage





### Pico LED Ø 40 mm | Einbau-Downlight

CRI 90

Dezentes Ambiente



#### Informationen

- Licht aus dem «Loch» – nicht sichtbar woher das Licht kommt
- Sehr gut entblendet
- hochwertige Materialien
- Farbe: weiss, ~RAL 9003
- Rahmen auf Wunsch lackierbar
- IP44 von unten bei geschlossener Decke

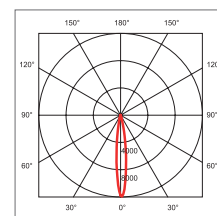
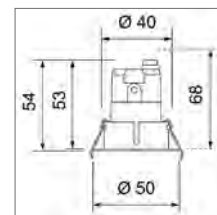

Empfohlenes Einbetoniergehäuse (nicht für Sichtbeton geeignet)  
 von AGRO AG / Kaiser: 920 858 329  
 Frontring: 920 896 109

3 W
100 lm, 120 lm
2700 K, 3000 K, 4000 K
CRI 90
Abstrahlwinkel: 12°
50'000h L70
700 mA
U <sub>F</sub> 2.7 – 3.2 V



Farbtemperatur	Lichtstrom	Art.-Nr.	CHF
2700 K	100 lm	130-203-20	52.00
3000 K	100 lm	130-203-70	52.00
4000 K	120 lm	130-203-40	52.00

Empfohlene Treiber	Seite	Art.-Nr.	CHF
 4 W, 700 mA, IP65	397	043-700-04	30.00
  10 W, 500 – 700 mA, rund, ab 2 Leuchten	402	200-019-010	74.00

### Pico LED Ø 68 mm | Einbau-Downlight

CRI 90

Dezentes Ambiente



#### Informationen

- Licht aus dem «Loch» – nicht sichtbar woher das Licht kommt
- Sehr gut entblendet
- hochwertige Materialien
- Farbe: weiss, ~RAL 9003
- Rahmen auf Wunsch lackierbar
- IP44 von unten bei geschlossener Decke

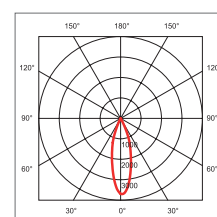
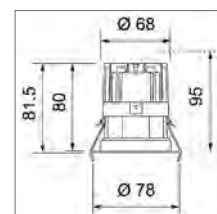





Empfohlenes Einbetoniergehäuse von  
 AGRO AG / Kaiser: 920 858 329  
 Frontring: 920 896 209

13 W
700 lm, 730 lm
2700 K, 3000 K, 4000 K
CRI 90
Abstrahlwinkel: 25°
50'000h L70
350 mA
U <sub>F</sub> 32 – 36 V



Farbtemperatur	Lichtstrom	EEK	Art.-Nr.	CHF
2700 K	700 lm	F	130-204-20	94.00
3000 K	700 lm	E	130-204-70	94.00
4000 K	730 lm	F	130-204-40	94.00

Empfohlene Treiber	Seite	Art.-Nr.	CHF
 20 W, 350 mA	396	043-350-20	40.00
 18 W, 350 mA	399	043-350-18	59.00
  25 W, 260 – 700 mA	403	043-001-025	74.00

Zubehör	Art.-Nr.	CHF
Deckeneinbauring, schwarz, matt, ~RAL 9005	130-204-99	31.00





## Mira II LED Ø 68 mm | Einbau-Downlight

CRI 90

Richtbare Qualität



### Informationen

- 55° schwenkbar
- 355° drehbar
- einfache Leuchtenpositionierung
- geeignet für Beleuchtung von Wänden und Regalen
- hoher Lichtkomfort und Wirtschaftlichkeit

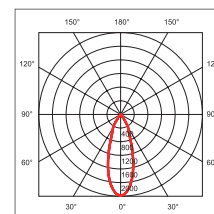
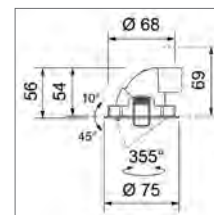

Empfohlenes Einbetoniergehäuse von  
AGRO AG / Kaiser: 920 858 329  
Frontring: 920 896 209

6.1 W
480 lm, 500 lm
2700 K, 3000 K
CRI 90
Abstrahlwinkel: 36°
50'000h L70
350 mA
U <sub>F</sub> 15.5 – 18.5 V



Farbtemperatur	Farbe	Lichtstrom	Art.-Nr.	CHF
2700 K	weiss, matt, ~RAL 9016	480 lm	130-207-20	84.00
3000 K	weiss, matt, ~RAL 9016	500 lm	130-207-70	84.00
3000 K	schwarz, matt, ~RAL 9004	500 lm	130-208-70	84.00

Empfohlene Treiber	Seite	Art.-Nr.	CHF
20 W, 350 mA	396	043-350-20	40.00
9 W, 350 mA	398	043-350-12	47.00
12 W, 180 – 500 mA	403	043-001-012	69.00
10 W, 260 – 350 mA, rund	402	200-018-010	74.00

## Mira II LED Ø 75 mm | Einbau-Downlight

CRI 90

NEW

Richtbare Qualität



### Informationen

- 60° schwenkbar
- 355° drehbar
- einfache Leuchtenpositionierung
- geeignet für Beleuchtung von Wänden und Regalen
- hoher Lichtkomfort und Wirtschaftlichkeit

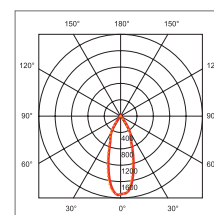
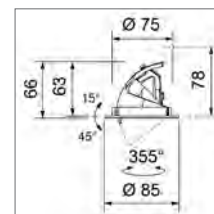

Empfohlenes Einbetoniergehäuse von  
AGRO AG / Kaiser: 920 858 329  
Frontring: 920 896 219

8.3 W
850 lm
3000 K
CRI 90
Abstrahlwinkel: 36°
50'000h L70
260 mA
U <sub>F</sub> 32 – 34 V



Farbe	Art.-Nr.	CHF
weiss, strukturiert, ~RAL 9003	130-209-70	94.00
schwarz, strukturiert, ~RAL 9005	130-210-70	94.00

Empfohlene Treiber	Seite	Art.-Nr.	CHF
9 W, 260 mA	398	043-260-09	47.00
12 W, 180 – 500 mA	403	043-001-012	69.00

Zubehör	Art.-Nr.	CHF
Reflektor, 50°	130-209-90	16.00

## Mira II LED Ø 100 mm | Einbau-Downlight

Richtbare Qualität

CRI  
90

NEW



### Informationen

- 60° schwenkbar
- 355° drehbar
- einfache Leuchtenpositionierung
- geeignet für Beleuchtung von Wänden und Regalen
- hoher Lichtkomfort und Wirtschaftlichkeit

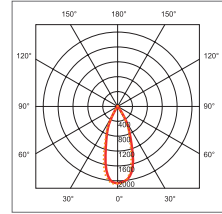
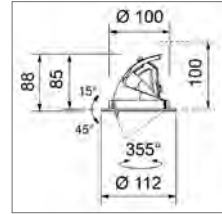

Empfohlenes Einbetoniergehäuse von  
AGRO AG / Kaiser: 920 858 359  
Frontring: 920 896 409

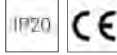
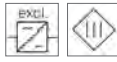

11.6 W
1200 lm
3000 K
CRI 90
Abstrahlwinkel: 36°
50'000h L70
350 mA
U <sub>F</sub> 32 – 34 V



Farbe	Art.-Nr.	CHF
weiss, strukturiert, ~RAL 9003	130-211-70	129.00
schwarz, strukturiert, ~RAL 9005	130-212-70	129.00

Empfohlene Treiber	Seite	Art.-Nr.	CHF
 20 W, 350 mA	396	043-350-20	40.00
 12 W, 350 mA	398	043-350-13	48.00
 12 W, 180 – 500 mA	403	043-001-012	69.00

Zubehör	Art.-Nr.	CHF
Reflektor, 20°	25817-041-98	19.00
Reflektor, 50°	25817-041-97	19.00

## Mira II LED Ø 125 mm | Einbau-Downlight

Richtbare Qualität

CRI  
90

NEW



### Informationen

- 60° schwenkbar
- 355° drehbar
- einfache Leuchtenpositionierung
- geeignet für Beleuchtung von Wänden und Regalen
- hoher Lichtkomfort und Wirtschaftlichkeit
- Farbe: weiss, ~RAL 9003
- Finish: strukturiert

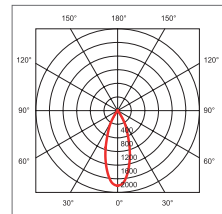
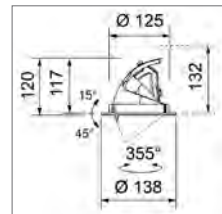

Empfohlenes Einbetoniergehäuse von  
AGRO AG / Kaiser: 920 858 359  
Frontring: 920 896 429  
Zwischenrahmen: 920 896 969



16.5 W
1900 lm
3000 K
CRI 90
Abstrahlwinkel: 38°
50'000h L70
500 mA
U <sub>F</sub> 32 – 34 V



Variante	Art.-Nr.	CHF
	130-213-70	149.00

Empfohlene Treiber	Seite	Art.-Nr.	CHF
 20 W, 500 mA	396	043-500-20	40.00
 22 W, 500 mA	399	043-500-22	59.00
 25 W, 260 – 700 mA	403	043-001-025	74.00

Zubehör	Art.-Nr.	CHF
Reflektor, 20°	25817-042-98	24.00
Reflektor, 70°	25817-039-99	24.00



**Mira II LED**  Ø 150 mm | **Einbau-Downlight**

Richtbare Qualität

CRI  
90

NEW

**Informationen**

- 60° schwenkbar
- 355° drehbar
- einfache Leuchtenpositionierung
- geeignet für Beleuchtung von Wänden und Regalen
- hoher Lichtkomfort und Wirtschaftlichkeit
- Farbe: weiss, ~RAL 9003
- Finish: strukturiert

Empfohlenes Einbetoniergehäuse (nicht für Sichtbeton geeignet) von AGRO AG / Kaiser: 920 858 399

Frontring: 920 896 589

Zwischenrahmen: 920 896 699

Wandeinbausatz: 920 879 539

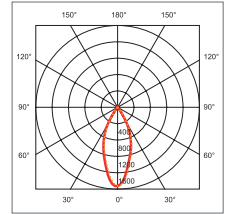
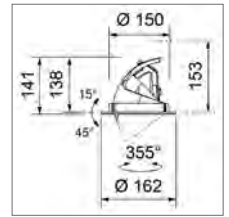

23.2 W

2550 lm, 2700 lm

3000 K, 4000 K

CRI 90



Abstrahlwinkel: 38°

50'000h L70

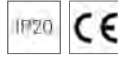
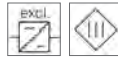
700 mA

U<sub>F</sub> 32 – 34 V

Farbtemperatur	Lichtstrom	Art.-Nr.	CHF
3000 K	2550 lm	130-215-70	169.00
4000 K	2700 lm	130-215-40	169.00

Empfohlene Treiber	Seite	Art.-Nr.	CHF
 40 W, 700 mA	396	043-700-42	54.00
 40 W, 700 mA	400	200-006-002	64.00
 25 W, 260 – 700 mA	403	043-001-025	74.00

Zubehör	Art.-Nr.	CHF
Frontplatte, Ø 150 mm, für Sichtbeton	27025-003-94	auf Anfrage
Reflektor, 20°	25817-042-98	24.00
Reflektor, 70°	25817-039-99	24.00





**RIDL 7 GU10 | Leuchtmittel**

GU10 in Bestform

**CRI  
90****Informationen**

- perfekt dimmbar
- passend für fast alle GU10 Downlights
- integriertes und berechnetes Kühlmanagement
- ersetzt ein 50 Watt Halogen-Leuchtmittel
- entblendetes Leuchtmittel
- homogene Lichtverteilung

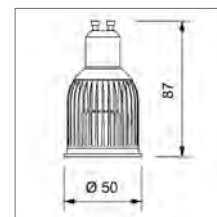

7.6 W

510 lm, 540 lm

2700 K, 3000 K

CRI 90

Abstrahlwinkel: 20°, 38°

40'000h L70 B10

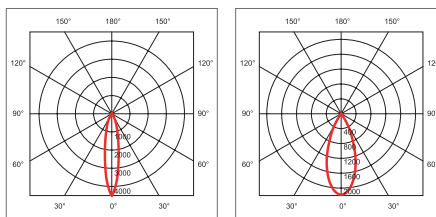

Variante	Abstrahlwinkel	Farbtemperatur	Art.-Nr.	CHF
R/C	20°	2700 K	130-720-21	52.00
R/C	20°	3000 K	130-720-71	52.00
R/C	38°	2700 K	130-738-21	52.00
R/C	38°	3000 K	130-738-71	52.00

Zubehör	Art.-Nr.	CHF
Schutzglas	RI-111-907-98	10.60
Reflektor, gold, 20°	130-890-90	22.00
Reflektor, gold, 38°	130-890-91	22.00

**RIDL 8 II | Leuchtmittel**

Brilliantes Licht

CRI  
90

NEW

**Informationen**

- ersetzt ein 50 Watt Halogen-Leuchtmittel
- passt in alle Halogen Downlight-Fassungen
- integriertes und berechnetes Kühlmanagement
- entblendetes Leuchtmittel
- mit steckbarem Anschlusskabel
- inkl. Schutzglas

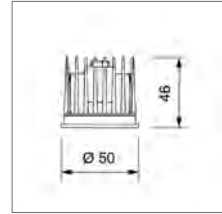

6.1 W

510 lm, 540 lm, 580 lm

2700 K, 3000 K, 4000 K

CRI 90

Abstrahlwinkel: 20°, 38°

35'000h L80 B10

350 mA

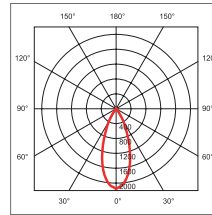
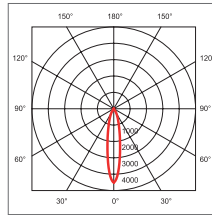
U<sub>e</sub> 15.5 – 18.5 V

Abstrahlwinkel	Farbtemperatur	Art.-Nr.	CHF
20°	2700 K	130-850-20	36.00
20°	3000 K	130-850-70	36.00
38°	2700 K	130-851-20	36.00
38°	3000 K	130-851-70	36.00
38°	4000 K	130-851-40	36.00

Zubehör	Art.-Nr.	CHF
Reflektor, gold, 20°	130-890-90	22.00
Reflektor, gold, 38°	130-890-91	22.00

Empfohlene Treiber	Seite	Art.-Nr.	CHF
9 W, 350 mA	398	043-350-12	47.00
12 W, 180 – 500 mA	403	043-001-012	69.00
10 W, 260 – 350 mA, rund	402	200-018-010	74.00

**RIDL 8 Dim to Warm | Leuchtmittel**

für echtes Wohlfühlambiente



0.2 – 6.3 W

40 – 510 lm

2000 – 2800 K

CRI 80

Abstrahlwinkel: 38°

35'000h L70

350 mA

U<sub>F</sub> 11 – 18 V**Informationen**

- Farbtemperatur von 2000 bis 2800 K durch Dimmung einstellbar
- passt in alle Halogen Downlight-Fassungen
- integriertes und berechnetes Kühlmanagement
- entblendetes Leuchtmittel
- mit steckbarem Anschlusskabel
- nur in Kombination mit Treiber mit Amplitudenmodulation (AM)

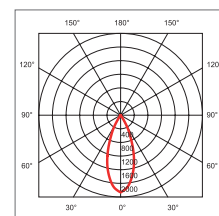
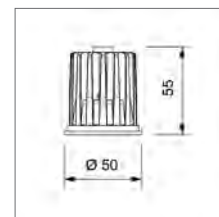

Farbtemperatur	Art.-Nr.	CHF
2000 – 2800 K	130-838-80	47.00

Zubehör	Art.-Nr.	CHF
Schutzglas	RI-111-907-98	10.60
Reflektor, gold, 20°	130-890-90	22.00
Reflektor, gold, 38°	130-890-91	22.00

Empfohlene Treiber	Seite	Art.-Nr.	CHF
9 W, 350 mA	398	043-350-12	47.00
10 W, 260 – 350 mA, rund	402	200-018-010	74.00





**RIDL 9 | Leuchtmittel**

Brillanz neu definiert

**CRI  
90****Informationen**

- ersetzt ein 50 Watt Niedervolt-Halogen-Leuchtmittel
- entblendetes Leuchtmittel
- mit steckbarem Anschlusskabel
- inkl. Schutzglas

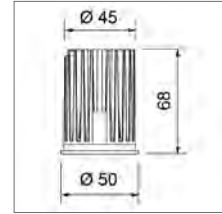

9 W

740 lm, 770 lm, 810 lm

2700 K, 3000 K, 4000 K

CRI 90

Abstrahlwinkel: 38°, 60°

30'000h L70 B10

500 mA

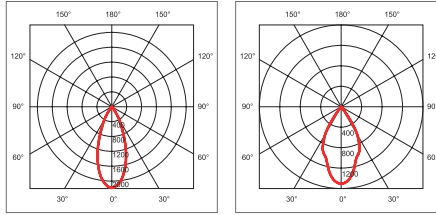
U<sub>e</sub> 15.5 – 18.5 V

Abstrahlwinkel	Farbtemperatur	Art.-Nr.	CHF
38°	2700 K	130-843-20	47.00
38°	3000 K	130-843-70	47.00
38°	4000 K	130-843-40	47.00
60°	2700 K	130-844-20	47.00
60°	3000 K	130-844-70	47.00
60°	4000 K	130-844-40	47.00

Zubehör	Art.-Nr.	CHF
Reflektor, gold, 20°	130-890-90	22.00
Reflektor, gold, 38°	130-890-91	22.00

Empfohlene Treiber	Seite	Art.-Nr.	CHF
 12 W, 500 mA	399	043-500-12	48.00
 12 W, 180 – 500 mA	403	043-001-012	69.00
 10 W, 500 – 700 mA, rund	402	200-019-010	74.00

**RIDL 9 Vivid | Leuchtmittel**

lebendige Farben mit Tiefe

**CRI  
90**

9 W
770 lm
3000 K
CRI 90
Abstrahlwinkel: 38°
30'000h L70 B10
500 mA
U <sub>F</sub> 15.5 – 18.5 V

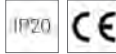

**Informationen**

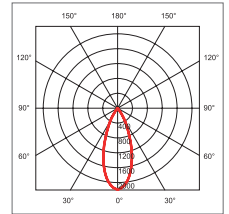
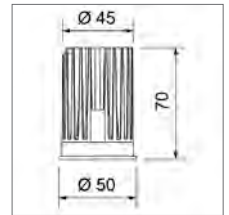
- beste Farbsättigung über das gesamte Spektrum
- pures Weiss
- ideal für Boutiquen, Shops und Restaurants
- entblendetes Leuchtmittel
- mit steckbarem Anschlusskabel
- inkl. Schutzglas



Variante	Art.-Nr.	CHF
	130-845-70	52.00

Zubehör	Art.-Nr.	CHF
Reflektor, 60°	130-890-99	16.00

Empfohlene Treiber	Seite	Art.-Nr.	CHF
 12 W, 500 mA	399	043-500-12	48.00
 12 W, 180 – 500 mA	403	043-001-012	69.00
 10 W, 500 – 700 mA, rund	402	200-019-010	74.00

**RIDL 13 | Leuchtmittel**

Brillant und kraftvoll

**CRI  
90****Informationen**

- entblendetes Leuchtmittel
- mit steckbarem Anschlusskabel

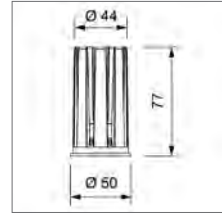

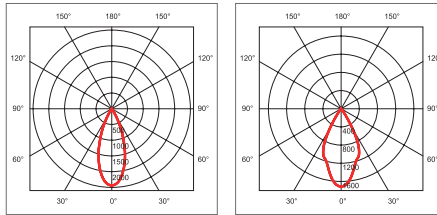

12 W
1130 lm, 1200 lm, 1300 lm
2700 K, 3000 K, 4000 K
CRI 90
Abstrahlwinkel: 38°, 60°
30'000h L70 B20
350 mA
U <sub>e</sub> 31 – 37 V



Abstrahlwinkel	Farbtemperatur	EEK	Art.-Nr.	CHF
38°	2700 K	F	130-841-20	59.00
38°	3000 K	F	130-841-70	59.00
38°	4000 K	E	130-841-40	59.00
60°	2700 K	F	130-842-20	59.00
60°	3000 K	F	130-842-70	59.00
60°	4000 K	E	130-842-40	59.00

Zubehör	Art.-Nr.	CHF
Schutzglas	RI-111-907-98	10.60
Reflektor, 20°	130-890-96	16.00
Reflektor, gold, 20°	130-890-90	22.00
Reflektor, gold, 38°	130-890-91	22.00

Empfohlene Treiber	Seite	Art.-Nr.	CHF
 18 W, 350 mA	399	043-350-18	59.00
 25 W, 260 – 700 mA	403	043-001-025	74.00

**RIDL 13 Tunable White | Leuchtmittel**

dynamische Farbtemperatur

**CRI  
90****Informationen**

- stufenlos regulierbare Farbtemperatur von Kalt- bis Warmweiss
- entblendetes Leuchtmittel
- mit steckbarem Anschlusskabel
- max. 700 mA kombiniert auf 2 Eingänge
- inkl. Schutzglas

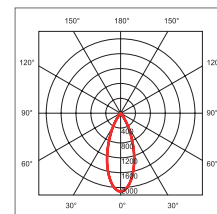
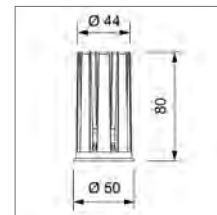

12.5 W

1000 – 1160 lm

2700 – 6500 K

CRI 90

Abstrahlwinkel: 38°

50'000h L80 B50

700 mA

U<sub>F</sub> 16 – 19 V

Variante

Art.-Nr.

CHF

130-841-90

79.00

Zubehör

Art.-Nr.

CHF

Reflektor, 60°

130-890-99

16.00

Empfohlene Treiber

Seite

Art.-Nr.

CHF

25 W, 260 – 700 mA, DT8, TW

404

043-002-025

89.00



## Unex Lamp GU10 | Leuchtmittel

Qualitäts LED-Spot

CRI  
90

NEW



### Informationen

- perfekt dimmbar
- passend für GU10 Lampenfassung
- ersetzt ein 50 Watt Halogen-Leuchtmittel
- Linsenoptik

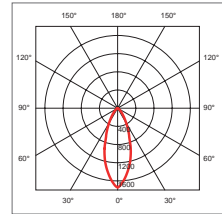

6 W

450 lm, 470 lm

2700 K, 3000 K

CRI 90

Abstrahlwinkel: 38°

25'000h L70



230V



Variante	Farbtemperatur	Lichtstrom	Art.-Nr.	CHF
↙ R.C	2700 K	450 lm	130-106-20	12.90
↘ R.C	3000 K	470 lm	130-106-70	12.90

## Unex Lamp E27 | Leuchtmittel

wie eine Glühlampe

CRI  
90

NEW



### Informationen

- passend für E27 Lampenfassung
- homogene Lichtverteilung
- ersetzt eine 75 W Glühbirne
- dimmbar

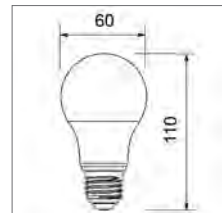

9 W

800 lm

2700 K

CRI 90

Abstrahlwinkel: 220°

25'000h L70



230V



Variante	Farbtemperatur	Art.-Nr.	CHF
↙ R.C	2700 K	130-107-20	13.90

## Philips Classic LED E27 | Leuchtmittel

wie eine Glühlampe



10.5 W  
1521 lm  
2700 K  
CRI 80  
Abstrahlwinkel: 320°  
15'000h



### Informationen

- passend für E27 Lampenfassung
- homogene Lichtverteilung
- ersetzt eine 100 W Glühbirne

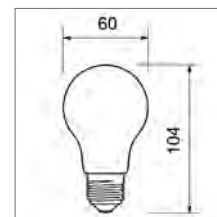

Variante	Farbtemperatur	Art.-Nr.	CHF
🔌	2700 K	130-105-20	14.30

## GU10 | Fassung



### Informationen

- Keramikfassung
- schnelle Installation ohne Werkzeug
- Leuchtmittel lässt sich dank langem Anschlusskabel problemlos ausrichten

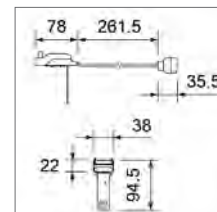

Variante	Art.-Nr.	CHF
	130-415-00	5.20



Deckeneinbauring  
**Swing 68**







## Swing 68 Ø 68 mm | Deckeneinbauring

verschmilzt mit der Decke



### Informationen

- hochwertiger Deckeneinbauring aus Aluminium
- Aussering leicht abgeschrägt
- Leuchtmittelwechsel von unten ohne Ringdemontage
- max. 13 W (LED)
- 60° schwenkbar (2 x 30°)
- Leuchtmittel gut entblendet (zurückversetzt)
- eine Haltefeder sichert das Leuchtmittel

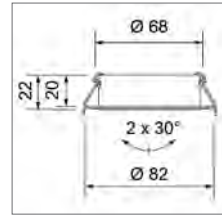

Empfohlene Einbetoniergehäuse von AGRO AG / Kaiser

GU10 Version: 920 858 319

Frontring: 920 896 209

Zwischenrahmen: 920 896 949 (RIDL 7 GU10)

Treiber Version: 920 858 329

Frontring: 920 896 209

### mit Spannfedern

Farbe/Finish	Art.-Nr.	CHF
weiss, strukturiert, ~RAL 9003	130-400-01	14.30
schwarz, strukturiert, ~RAL 9004	130-400-02	14.30
alu-gebürstet	130-400-03	14.30
alu-glänzend	130-400-04	14.30
gold, eloxiert	130-400-05	14.30
<b>NEW</b> bronze, gebürstet	130-400-06	18.60

### mit Blattfedern







Farbe/Finish	Art.-Nr.	CHF
weiss, strukturiert, ~RAL 9003	130-401-01	14.30
schwarz, strukturiert, ~RAL 9004	130-401-02	14.30
alu-gebürstet	130-401-03	14.30
alu-glänzend	130-401-04	14.30
gold, eloxiert	130-401-05	14.30

### Zubehör

Art.-Nr.	CHF	
GU10 Fassung	130-415-00	5.20

### Ersatzteil

Art.-Nr.	CHF	
<b>NEW</b> Spannfeder, 1 Stück	130-400-99	1.30

Leuchtmittlempfehlung	Lichtsteuerung	Einbautiefe	Seite
RIDL 7 GU10		124 mm	189
RIDL 8 II		67 mm	190
RIDL 8, Dim to Warm		76 mm	191
RIDL 9		89 mm	192, 193
RIDL 13		98 mm	194
RIDL 13 Tunable White		101 mm	195
Unex Lamp GU10		91 mm	196

## Swing 68 Plan Ø 68 mm | Deckeneinbauring

pur in seiner Form



### Informationen

- hochwertiger Deckeneinbauring aus Aluminium
- Leuchtmittelwechsel von unten ohne Ringdemontage
- max. 13 W (LED)
- 60° schwenkbar (2 x 30°)
- Leuchtmittel gut entblendet (zurückversetzt)
- eine Haltefeder sichert das Leuchtmittel

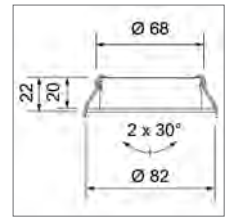

Empfohlene Einbetoniergehäuse von AGRO AG / Kaiser

GU10 Version: 920 858 319

Frontring: 920 896 209

Zwischenrahmen: 920 896 949 (RIDL 7 GU10)

Treiber Version: 920 858 329

Frontring: 920 896 209

### mit Spannfedern

Farbe/Finish	Art.-Nr.	CHF
weiss, strukturiert, ~RAL 9003	130-403-01	14.30
schwarz, strukturiert, ~RAL 9004	130-403-02	14.30
alu-gebürstet	130-403-03	14.30
alu-glänzend	130-403-04	14.30
gold, eloxiert	130-403-05	14.30

### mit Blattfedern

Farbe/Finish	Art.-Nr.	CHF
weiss, strukturiert, ~RAL 9003	130-404-01	14.30
schwarz, strukturiert, ~RAL 9004	130-404-02	14.30
alu-gebürstet	130-404-03	14.30
alu-glänzend	130-404-04	14.30
gold, eloxiert	130-404-05	14.30

### Zubehör

	Art.-Nr.	CHF
GU10 Fassung	130-415-00	5.20

### Ersatzteil

	Art.-Nr.	CHF
<b>NEW</b> Spannfeder, 1 Stück	130-400-99	1.30

Leuchtmittlempfehlung	Lichtsteuerung	Einbautiefe	Seite
RIDL 7 GU10		124 mm	189
RIDL 8 II		67 mm	190
RIDL 8, Dim to Warm		76 mm	191
RIDL 9		89 mm	192, 193
RIDL 13		98 mm	194
RIDL 13 Tunable White		101 mm	195
Unex Lamp GU10		91 mm	196

## Swing 80 Ø 68 – 80 mm | Deckeneinbauring

verschmilzt mit der Decke



### Informationen

- hochwertiger Deckeneinbauring aus Aluminium
- Aussering leicht abgeschrägt
- Leuchtmittelwechsel von unten ohne Ringdemontage
- max. 13 W (LED)
- 60° schwenkbar (2 x 30°)
- Leuchtmittel gut entblendet (zurückversetzt)
- eine Haltefeder sichert das Leuchtmittel

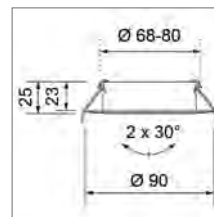

Empfohlene Einbetoniergehäuse von AGRO AG / Kaiser

GU10 Version: 920 858 319

Frontring: 920 896 229

Zwischenrahmen: 920 896 949 (RIDL 7 GU10)

Treiber Version: 920 858 329

Frontring: 920 896 229

### mit Spannfedern

















Farbe/Finish	Art.-Nr.	CHF
weiss, strukturiert, ~RAL 9003	130-405-01	16.70
schwarz, strukturiert, ~RAL 9004	130-405-02	16.70
alu-gebürstet	130-405-03	16.70
alu-glänzend	130-405-04	16.70
gold, eloxiert	130-405-05	16.70
<b>NEW</b> bronze, gebürstet	130-405-06	21.00

### mit Blattfedern

Farbe/Finish	Art.-Nr.	CHF
weiss, strukturiert, ~RAL 9003	130-406-01	16.70
schwarz, strukturiert, ~RAL 9004	130-406-02	16.70
alu-gebürstet	130-406-03	16.70
alu-glänzend	130-406-04	16.70
gold, eloxiert	130-406-05	16.70

### Zubehör

Zubehör	Art.-Nr.	CHF
GU10 Fassung	130-415-00	5.20

Leuchtmittlempfehlung	Lichtsteuerung	Einbautiefe	Seite
RIDL 7 GU10		124 mm	189
RIDL 8 II	  	67 mm	190
RIDL 8, Dim to Warm	  	76 mm	191
RIDL 9	  	89 mm	192, 193
RIDL 13	  	98 mm	194
RIDL 13 Tunable White	 	101 mm	195
Unex Lamp GU10		91 mm	196

## Swing 80 Plan Ø 68 – 80 mm | Deckeneinbauring

pur in seiner Form



### Informationen

- hochwertiger Deckeneinbauring aus Aluminium
- Leuchtmittelwechsel von unten ohne Ringdemontage
- max. 13 W (LED)
- 60° schwenkbar (2 x 30°)
- Leuchtmittel gut entblendet (zurückversetzt)
- eine Haltefeder sichert das Leuchtmittel

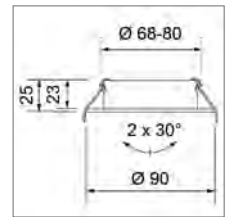

Empfohlene Einbetoniergehäuse von AGRO AG / Kaiser

GU10 Version: 920 858 319

Frontring: 920 896 229

Zwischenrahmen: 920 896 949 (RIDL 7 GU10)

Treiber Version: 920 858 329

Frontring: 920 896 229

### mit Spannfedern

Farbe/Finish	Art.-Nr.	CHF
weiss, strukturiert, ~RAL 9003	130-407-01	16.70
schwarz, strukturiert, ~RAL 9004	130-407-02	16.70
alu-gebürstet	130-407-03	16.70

### mit Blattfedern

Farbe/Finish	Art.-Nr.	CHF
weiss, strukturiert, ~RAL 9003	130-408-01	16.70
schwarz, strukturiert, ~RAL 9004	130-408-02	16.70
alu-gebürstet	130-408-03	16.70

### Zubehör

	Art.-Nr.	CHF
GU10 Fassung	130-415-00	5.20

Leuchtmittelempfehlung	Lichtsteuerung	Einbautiefe	Seite
RIDL 7 GU10		124 mm	189
RIDL 8 II		67 mm	190
RIDL 8, Dim to Warm		76 mm	191
RIDL 9		89 mm	192, 193
RIDL 13		98 mm	194
RIDL 13 Tunable White		101 mm	195
Unex Lamp GU10		91 mm	196



## Twist 80 Plan Ø 80 mm | Deckeneinbauring

bewährtes Design in neuer Qualität



### Informationen

- hochwertiger Deckeneinbauring aus Aluminium
- Leuchtmittelwechsel von unten ohne Ringdemontage
- max. 13 W (LED)
- 60° schwenkbar (2 x 30°)
- 350° drehbar
- Leuchtmittel gut entblendet (zurückversetzt)
- eine Haltefeder sichert das Leuchtmittel
- Klickverschluss-System

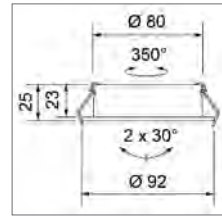

Empfohlene Einbetoniergehäuse von AGRO AG / Kaiser

GU10 Version: 920 858 319

Frontring: 920 896 229

Zwischenrahmen: 920 896 949 (RIDL 7 GU10)

Treiber Version: 920 858 329

Frontring: 920 896 229

### mit Spannfedern

















Farbe/Finish	Art.-Nr.	CHF
weiss, strukturiert, ~RAL 9003	130-409-01	18.90
schwarz, strukturiert, ~RAL 9004	130-409-02	18.90
alu-gebürstet	130-409-03	18.90

### mit Blattfedern

Farbe/Finish	Art.-Nr.	CHF
weiss, strukturiert, ~RAL 9003	130-410-01	18.90
schwarz, strukturiert, ~RAL 9004	130-410-02	18.90
alu-gebürstet	130-410-03	18.90

### Zubehör

	Art.-Nr.	CHF
GU10 Fassung	130-415-00	5.20

Leuchtmittlempfehlung	Lichtsteuerung	Einbautiefe	Seite
RIDL 7 GU10		126 mm	189
RIDL 8 II	  	69 mm	190
RIDL 8, Dim to Warm	  	78 mm	191
RIDL 9	  	91 mm	192, 193
RIDL 13	  	100 mm	194
RIDL 13 Tunable White	 	103 mm	195
Unex Lamp GU10		93 mm	196

## Twist 80 Square Plan Ø 80 mm | Deckeneinbauring

bewährtes Design in neuer Qualität



### Informationen

- hochwertiger Deckeneinbauring aus Aluminium
- Leuchtmittelwechsel von unten ohne Ringdemontage
- max. 13 W (LED)
- 60° schwenkbar (2 x 30°)
- 350° drehbar
- Leuchtmittel gut entblendet (zurückversetzt)
- eine Haltefeder sichert das Leuchtmittel
- Klickverschluss-System

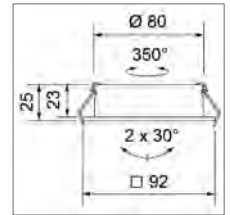

Empfohlene Einbetoniergehäuse von AGRO AG / Kaiser

GU10 Version: 920 858 319

Frontring: 920 896 229

Zwischenrahmen: 920 896 949 (RIDL 7 GU10)

Treiber Version: 920 858 329

Frontring: 920 896 229

### mit Spannfedern







Farbe/Finish	Art.-Nr.	CHF
weiss, strukturiert, ~RAL 9003	130-411-01	18.90
schwarz, strukturiert, ~RAL 9004	130-411-02	18.90
alu-gebürstet	130-411-03	18.90

### mit Blattfedern

Farbe/Finish	Art.-Nr.	CHF
weiss, strukturiert, ~RAL 9003	130-412-01	18.90
schwarz, strukturiert, ~RAL 9004	130-412-02	18.90
alu-gebürstet	130-412-03	18.90

### Zubehör

	Art.-Nr.	CHF
GU10 Fassung	130-415-00	5.20

Leuchtmittlempfehlung	Lichtsteuerung	Einbautiefe	Seite
RIDL 7 GU10		126 mm	189
RIDL 8 II		69 mm	190
RIDL 8, Dim to Warm		78 mm	191
RIDL 9		91 mm	192, 193
RIDL 13		100 mm	194
RIDL 13 Tunable White		103 mm	195
Unex Lamp GU10		93 mm	196

## Twist 100 Plan Ø 90 – 100 mm | Deckeneinbauring

bewährtes Design in neuer Grösse



### Informationen

- hochwertiger Deckeneinbauring aus Aluminium
- Leuchtmittelwechsel von unten ohne Ringdemontage
- max. 13 W (LED)
- 60° schwenkbar (2 x 30°)
- Leuchtmittel gut entblendet (zurückversetzt)
- eine Haltefeder sichert das Leuchtmittel
- mit vormontierten Spannfedern
- Blattfedern als Zubehör beiliegend

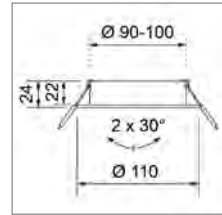

Empfohlene Einbetoniergehäuse von AGRO AG / Kaiser

GU10 Version: 920 858 319

Frontring: 920 896 269







Zwischenrahmen: 920 896 949 (RIDL 7 GU10)

Treiber Version: 920 858 329

Frontring: 920 896 269

Farbe/Finish	Art.-Nr.	CHF
weiss, strukturiert, ~RAL 9003	130-414-01	22.40
schwarz, strukturiert, ~RAL 9004	130-414-02	22.40
alu-gebürstet	130-414-03	22.40

Zubehör	Art.-Nr.	CHF
GU10 Fassung	130-415-00	5.20

Leuchtmittlempfehlung	Lichtsteuerung	Einbautiefe	Seite
RIDL 7 GU10		124 mm	189
RIDL 8 II		67 mm	190
RIDL 8, Dim to Warm		76 mm	191
RIDL 9		89 mm	192, 193
RIDL 13		98 mm	194
RIDL 13 Tunable White		101 mm	195
Unex Lamp GU10		91 mm	196

## Twist 2X Square Plan 164 x 80 mm | Deckeneinbauring

bewährtes Design in neuer Grösse



### Informationen

- hochwertiger Deckeneinbauring aus Aluminium
- Leuchtmittelwechsel von unten ohne Ringdemontage
- max. 2 x 13 W (LED)
- 60° schwenkbar (2 x 30°)
- 350° drehbar
- Leuchtmittel gut entblendet (zurückversetzt)
- eine Haltefeder sichert das Leuchtmittel
- Klickverschluss-System
- mit vormontierten Spannfedern

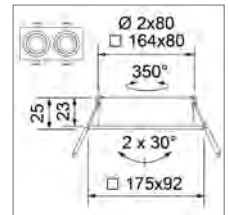

Empfohlene Einbetoniergehäuse von AGRO AG / Kaiser  
(nicht für Sichtbeton geeignet)

GU10 Version: 920 858 379

Frontring: 920 896 589







Zwischenrahmen: 920 896 689 (RIDL 7 GU10)

Treiber Version: 920 858 399

Frontring: 920 896 589

Farbe/Finish	Art.-Nr.	CHF
weiss, strukturiert, ~RAL 9003	130-413-01	33.60
schwarz, strukturiert, ~RAL 9004	130-413-02	33.60
alu-gebürstet	130-413-03	33.60

Zubehör	Art.-Nr.	CHF
GU10 Fassung	130-415-00	5.20
Blattfeder-Set	130-416-00	2.60
<b>NEW</b> Frontplatte, 164 x 80 mm, für Sichtbeton	27025-003-91	auf Anfrage

Leuchtmittlempfehlung	Lichtsteuerung	Einbautiefe	Seite
RIDL 7 GU10		126 mm	189
RIDL 8 II		69 mm	190
RIDL 8, Dim to Warm		78 mm	191
RIDL 9		91 mm	192, 193
RIDL 13		100 mm	194
RIDL 13 Tunable White		103 mm	195
Unex Lamp GU10		93 mm	196



## Concave Ø 68 mm | Deckeneinbauring

zurückversetzt für ein ruhiges Deckenbild



### Informationen

- Leuchtmittel wird eingeschraubt
- nur in Kombination mit RIDL Leuchtmittel
- max. 13 W (LED)
- 40° schwenkbar (2 x 20°)

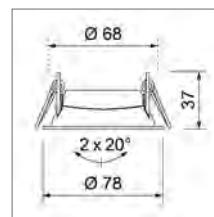

Empfohlene Einbetoniergehäuse von AGRO AG / Kaiser

GU10 Version: 920 858 319

Frontring: 920 896 209







Zwischenrahmen: 920 896 949

Treiber Version: 920 858 329

Frontring: 920 896 209

Farbe	Art.-Nr.	CHF
weiss, matt, ~RAL 9016	130-200-50	22.00

Zubehör	Art.-Nr.	CHF
GU10 Fassung	130-415-00	5.20

Leuchtmittlempfehlung	Lichtsteuerung	Einbautiefe	Seite
RIDL 7 GU10		132 mm	189
RIDL 8 II		75 mm	190
RIDL 8, Dim to Warm		84 mm	191
RIDL 9		97 mm	192, 193
RIDL 13		106 mm	194
RIDL 13 Tunable White		109 mm	195

## Concave Ø 75 mm | Deckeneinbauring

zurückversetzt für ein ruhiges Deckenbild



### Informationen

- Leuchtmittel wird eingeklipst
- max. 13 W (LED)
- 60° schwenkbar (2 x 30°)

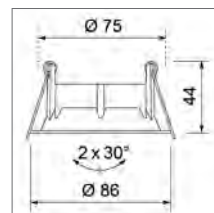

Empfohlene Einbetoniergehäuse von AGRO AG / Kaiser

GU10 Version: 920 858 319

Frontring: 920 896 219







Zwischenrahmen: 920 896 949 (RIDL 7 GU10)

Treiber Version: 920 858 329

Frontring: 920 896 219

Farbe	Art.-Nr.	CHF
weiss, matt, ~RAL 9016	130-201-00	27.00

Zubehör	Art.-Nr.	CHF
GU10 Fassung	130-415-00	5.20

Leuchtmittlempfehlung	Lichtsteuerung	Einbautiefe	Seite
RIDL 7 GU10		134 mm	189
RIDL 8 II		77 mm	190
RIDL 8, Dim to Warm		86 mm	191
RIDL 9		99 mm	192, 193
RIDL 13		108 mm	194
RIDL 13 Tunable White		111 mm	195
Unex Lamp GU10		101 mm	196

**Concave**  Ø 80 mm | **Deckeneinbauring**

zurückversetzt für ein ruhiges Deckenbild

**Informationen**

- Leuchtmittelwechsel von unten ohne Ringdemontage
- Bajonett-Verschluss
- max. 13 W (LED)
- 60° schwenkbar (2 x 30°)

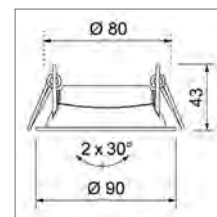

Empfohlene Einbetoniergehäuse von AGRO AG / Kaiser

GU10 Version: 920 858 319

Frontring: 920 896 229

Zwischenrahmen: 920 896 959 (RIDL 7 GU10)







Treiber Version: 920 858 329

Frontring: 920 896 229

Zwischenrahmen: 920 896 949 (RIDL 13 Tunable White)

Farbe	Art.-Nr.	CHF
weiss, matt, ~RAL 9016	130-201-50	32.00
schwarz, matt, ~RAL 9004	130-201-60	32.00

Zubehör	Art.-Nr.	CHF
GU10 Fassung	130-415-00	5.20

Leuchtmittlempfehlung	Lichtsteuerung	Einbautiefe	Seite
RIDL 7 GU10		140 mm	189
RIDL 8 II		83 mm	190
RIDL 8, Dim to Warm		92 mm	191
RIDL 9		105 mm	192, 193
RIDL 13		114 mm	194
RIDL 13 Tunable White		117 mm	195
Unex Lamp GU10		107 mm	196

## Mood Ø 68 mm | Deckeneinbauring

für alle Deckenszenarien



### Informationen

- Leuchtmittelwechsel von unten ohne Ringdemontage
- einfache und schnelle Installation
- max. 13 W (LED)
- 25° schwenkbar
- Deko-Rand in 5 Farben erhältlich, passend für jedes Interior

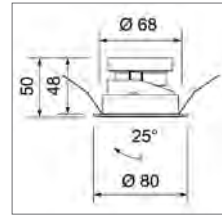

Empfohlene Einbetoniergehäuse von AGRO AG / Kaiser

**GU10 Version:** 920 858 319

Frontring: 920 896 209

Zwischenrahmen: 920 896 949 (Unex Lamp GU10)

Zwischenrahmen: 920 896 959 (RIDL 7 GU10)

**Treiber Version:** 920 858 329







Frontring: 920 896 209

Zwischenrahmen: 920 896 949 (RIDL 9, RIDL 13)



Farbe	Art.-Nr.	CHF
weiss, strukturiert, ~RAL 9003, Deko-Rand weiss	130-220-50	41.90
weiss, strukturiert, ~RAL 9003, Deko-Rand schwarz	130-220-51	41.90
weiss, strukturiert, ~RAL 9003, Deko-Rand chrom	130-220-52	41.90
weiss, strukturiert, ~RAL 9003, Deko-Rand gold	130-220-53	41.90
weiss, strukturiert, ~RAL 9003, Deko-Rand champagner	130-220-54	41.90
schwarz, strukturiert, ~RAL 9004, Deko-Rand weiss	130-220-60	41.90
schwarz, strukturiert, ~RAL 9004, Deko-Rand schwarz	130-220-61	41.90
schwarz, strukturiert, ~RAL 9004, Deko-Rand chrom	130-220-62	41.90
schwarz, strukturiert, ~RAL 9004, Deko-Rand gold	130-220-63	41.90
schwarz, strukturiert, ~RAL 9004, Deko-Rand champagner	130-220-64	41.90

Zubehör	Art.-Nr.	CHF
GU10 Fassung	130-415-00	5.20

Leuchtmittelpfehlung	Lichtsteuerung	Einbautiefe	Seite
RIDL 7 GU10		155 mm	189
RIDL 8 II		98 mm	190
RIDL 8, Dim to Warm		107 mm	191
RIDL 9		120 mm	192, 193
RIDL 13		129 mm	194
RIDL 13 Tunable White		132 mm	195
Unex Lamp GU10		122 mm	196

## Mood Trimless Ø 68 mm | Deckeneinbauring

nahtlos integriert

NEW



### Informationen

- Leuchtmittelwechsel von unten
- einfache und schnelle Installation
- inkl. Schutzdeckel
- max. 13 W (LED)
- Deko-Rand in 5 Farben erhältlich, passend für jedes Interior

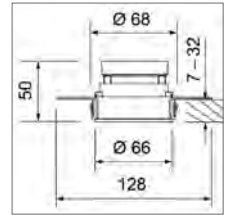

Empfohlene Einbetoniergehäuse von AGRO AG / Kaiser

GU10 Version: 920 858 319

Frontring: 920 896 209

Zwischenrahmen: 920 896 949 (Unex Lamp GU10)

Zwischenrahmen: 920 896 959 (RIDL 7 GU10)

Treiber Version: 920 858 329







Frontring: 920 896 209

Zwischenrahmen: 920 896 949 (RIDL 9, RIDL 13)



Farbe	Art.-Nr.	CHF
weiss, strukturiert, ~RAL 9003, Deko-Rand weiss	130-221-50	52.90
weiss, strukturiert, ~RAL 9003, Deko-Rand schwarz	130-221-51	52.90
weiss, strukturiert, ~RAL 9003, Deko-Rand chrom	130-221-52	52.90
weiss, strukturiert, ~RAL 9003, Deko-Rand gold	130-221-53	52.90
weiss, strukturiert, ~RAL 9003, Deko-Rand champagner	130-221-54	52.90
schwarz, strukturiert, ~RAL 9004, Deko-Rand weiss	130-221-60	52.90
schwarz, strukturiert, ~RAL 9004, Deko-Rand schwarz	130-221-61	52.90
schwarz, strukturiert, ~RAL 9004, Deko-Rand chrom	130-221-62	52.90
schwarz, strukturiert, ~RAL 9004, Deko-Rand gold	130-221-63	52.90
schwarz, strukturiert, ~RAL 9004, Deko-Rand champagner	130-221-64	52.90

Zubehör	Art.-Nr.	CHF
GU10 Fassung	130-415-00	5.20

Leuchtmittlempfehlung	Lichtsteuerung	Einbautiefe	Seite
RIDL 7 GU10		155 mm	189
RIDL 8 II		98 mm	190
RIDL 8, Dim to Warm		107 mm	191
RIDL 9		120 mm	192, 193
RIDL 13		129 mm	194
RIDL 13 Tunable White		132 mm	195
Unex Lamp GU10		122 mm	196





**Disc**  Ø 68 mm | **Deckeneinbauring**

IP44 für Nasszellen

**Informationen**

- max. 7 W (LED)
- inkl. GU10 Keramikfassung

Empfohlene Einbetoniergehäuse von AGRO AG / Kaiser

GU10 Version: 920 858 319

Frontring: 920 896 209





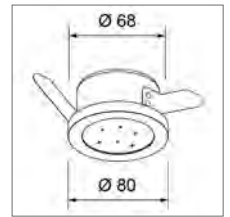

Zwischenrahmen: 920 896 959 (RIDL 7 GU10)

Treiber Version: 920 858 329

Frontring: 920 896 209



Finish	Art.-Nr.	CHF
alu-gebürstet	9321-014-98	41.90

Leuchtmittlempfehlung	Lichtsteuerung	Einbautiefe	Seite
RIDL 7 GU10		144 mm	189
RIDL 8 II	 	87 mm	190
RIDL 8, Dim to Warm	 	96 mm	191
Unex Lamp GU10		111 mm	196

**Disc**  Ø 68 mm, schwenkbar | **Deckeneinbauring**

IP44 für Nasszellen

**Informationen**

- 30° schwenkbar (2 x 15°)
- max. 7 W (LED)
- inkl. GU10 Keramikfassung

Empfohlene Einbetoniergehäuse von AGRO AG / Kaiser

GU10 Version: 920 858 319

Frontring: 920 896 209





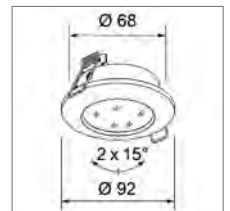

Zwischenrahmen: 920 896 949 (RIDL 7 GU10)

Treiber Version: 920 858 329

Frontring: 920 896 209



Finish	Art.-Nr.	CHF
alu-gebürstet	9321-015-98	41.90

Leuchtmittlempfehlung	Lichtsteuerung	Einbautiefe	Seite
RIDL 7 GU10		126 mm	189
RIDL 8 II	 	69 mm	190
RIDL 8, Dim to Warm	 	78 mm	191
Unex Lamp GU10		93 mm	196

## Twist Round GU10 | Aufbau-Downlight

bewährtes Design in neuer Qualität

NEW



### Informationen

- hochwertiges Aufbau-Downlight aus Aluminium
- inkl. GU10 Keramikfassung
- ohne Leuchtmittel GU10
- max. 7 W (LED)
- 60° schwenkbar (2 x 30°)
- Leuchtmittel gut entblendet (zurückversetzt)
- eine Haltefeder sichert das Leuchtmittel

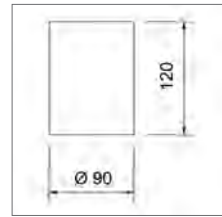

passend zu

Einbau-Downlight Twist, ab S. 146

Deckeneinbauring Twist, ab S. 204



Farbe	Art.-Nr.	CHF
weiss, strukturiert, ~RAL 9003	160-170-50	59.90
schwarz, strukturiert, ~RAL 9004	160-172-50	59.90
alu-gebürstet	160-171-50	59.90

Leuchtmittlempfehlung	Lichtsteuerung	Seite
Unex Lamp GU10	RC	196

## Twist Square GU10 | Aufbau-Downlight

bewährtes Design in neuer Qualität

NEW



### Informationen

- hochwertiges Aufbau-Downlight aus Aluminium
- inkl. GU10 Keramikfassung
- ohne Leuchtmittel GU10
- max. 7 W (LED)
- 60° schwenkbar (2 x 30°)
- Leuchtmittel gut entblendet (zurückversetzt)
- eine Haltefeder sichert das Leuchtmittel

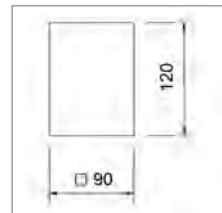

passend zu

Einbau-Downlight Twist, ab S. 146

Deckeneinbauring Twist, ab S. 204

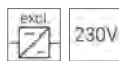

Farbe	Art.-Nr.	CHF
weiss, strukturiert, ~RAL 9003	160-173-50	64.90
schwarz, strukturiert, ~RAL 9004	160-175-50	64.90
alu-gebürstet	160-174-50	64.90

Leuchtmittlempfehlung	Lichtsteuerung	Seite
Unex Lamp GU10	RC	196

## Cilindro LED Ø 90 mm | Aufbau-Downlight

Kompakte Bauform



11 W, 15 W

900 lm, 1300 lm

3000 K

CRI 80

Abstrahlwinkel: 36°

50'000h L80

350 mA, 500 mA

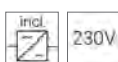
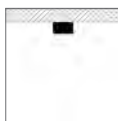

### Informationen

- ohne sichtbare Schrauben
- einfache Montage
- Leuchte aus Aluminium
- Farbe: weiss, ~RAL 9003
- Finish: strukturiert

passend zu

Aufbau-Downlight Cilindro Outdoor LED, S. 325

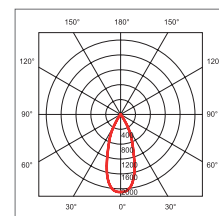
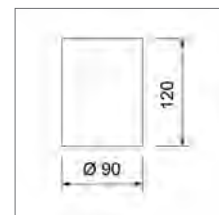

Variante	Leistung	Lichtstrom	Bestromung	EEK	Art.-Nr.	CHF
	11 W	900 lm	500 mA	F	25817-062-72	169.00
	15 W	1300 lm	350 mA	E	25817-061-72	199.00

### Zubehör

	Art.-Nr.	CHF
Reflektor, 20°	25817-041-98	19.00
Reflektor, 50°	25817-041-97	19.00

## Cilindro LED Ø 118 mm | Aufbau-Downlight

Kompakte Bauform



28 W, 28.5 W

2800 lm, 3000 lm

3000 K, 4000 K

CRI 80

Abstrahlwinkel: 40°

50'000h L80

700 mA

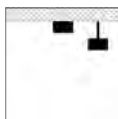

### Informationen

- ohne sichtbare Schrauben
- einfache Montage
- Leuchte aus Aluminium
- Farbe: weiss, ~RAL 9003
- Finish: strukturiert

passend zu

Aufbau-Downlight Cilindro Outdoor LED, S. 325

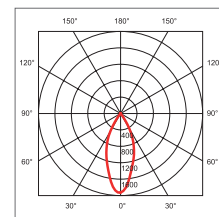
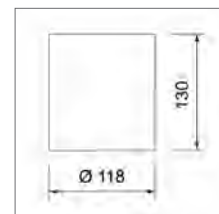

	Variante	Leistung	Lichtstrom	Farbtemperatur	EEK	Art.-Nr.	CHF
<b>NEW</b>		28 W	2800 lm	3000 K	E	25817-039-74	269.00
		28 W	3000 lm	4000 K	D	25817-039-43	269.00
<b>NEW</b>		28.5 W	2800 lm	3000 K	E	25817-063-74	• 369.00
		28.5 W	3000 lm	4000 K	D	25817-063-43	• 369.00

### Zubehör

	Art.-Nr.	CHF
Reflektor, 20°	25817-042-98	24.00
Reflektor, 70°	25817-039-99	24.00
Seilabhängung Set, L = 2500 mm	290-030-00	73.90







## Flat LED Modul 600 | Deckeneinbauleuchte

entblendet und effizient



### Informationen

- homogene Ausleuchtung
- UGR <19 dank mikroprismatischem Plexiglas
- für Einbau in Deckensysteme geeignet
- Deckenausschnitt in Kombination mit Spannfeder-Set: 570 – 580 x 570 – 580 mm
- Farbe: weiss, ~RAL 9016

inklusive Treiber

- 200-007-001, S. 400
- 043-001-045, S. 404

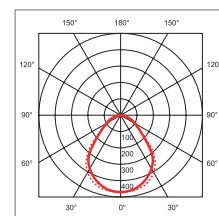
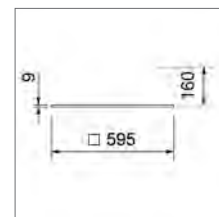

34 W, 34.5 W

3800 lm, 4100 lm

3000 K, 4000 K

CRI 80

Abstrahlwinkel: 80°

50'000h L70

900 mA

U<sub>F</sub> 33 – 38 V

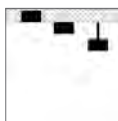

**NEW**  
**NEW**

Variante	Farbtemperatur	Leistung	Lichtstrom	Art.-Nr.	CHF
R/C	3000 K	34 W	3800 lm	160-059-70	189.00
R/C	4000 K	34 W	4100 lm	160-059-40	189.00
DALI 2	3000 K	34.5 W	3800 lm	160-060-70	229.00
DALI 2	4000 K	34.5 W	4100 lm	160-060-40	229.00

Zubehör (siehe auch Seite 222/223)	Art.-Nr.	CHF
Seilabhangung	160-015-52	51.90
Baldachin, inkl. Seilabhangung	160-014-51	84.00
Aufbaurahmen	160-016-51	99.00
Befestigungsfeder	160-013-96	43.90
Spannfeder-Set	160-013-95	41.90

## Flat LED Modul 625 | Deckeneinbauleuchte

entblendet und effizient



### Informationen

- homogene Ausleuchtung
- UGR <19 dank mikroprismatischem Plexiglas
- für Einbau in Deckensysteme geeignet
- Deckenausschnitt in Kombination mit Spannfeder-Set: 590 – 605 x 590 – 605 mm
- Farbe: weiss, ~RAL 9016

inklusive Treiber

- 200-007-001, S. 400
- 043-001-045, S. 404

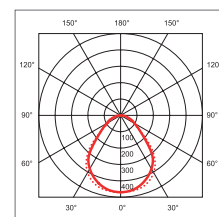
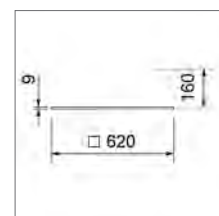

34 W, 34.5 W

3800 lm, 4100 lm

3000 K, 4000 K

CRI 80

Abstrahlwinkel: 80°

50'000h L70

900 mA

U<sub>F</sub> 33 – 38 V

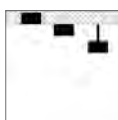

**NEW**  
**NEW**

Variante	Farbtemperatur	Leistung	Lichtstrom	Art.-Nr.	CHF
R/C	3000 K	34 W	3800 lm	160-061-70	189.00
R/C	4000 K	34 W	4100 lm	160-061-40	189.00
DALI 2	3000 K	34.5 W	3800 lm	160-062-70	229.00
DALI 2	4000 K	34.5 W	4100 lm	160-062-40	229.00

Zubehör (siehe auch Seite 222/223)	Art.-Nr.	CHF
Seilabhangung	160-015-52	51.90
Baldachin, inkl. Seilabhangung	160-014-51	84.00
Aufbaurahmen	160-017-50	99.00
Befestigungsfeder	160-013-96	43.90
Befestigungsbugel	160-013-97	41.90
Spannfeder-Set	160-013-95	41.90





**Flat Tunable White LED Modul 600 | Deckeneinbauleuchte**

dynamische Farbtemperatur

**Informationen**

- stufenlos regulierbare Farbtemperatur von Kalt- bis Warmweiss
- homogene Ausleuchtung
- UGR <19 dank mikroprismatischem Plexiglas
- für Einbau in Deckensysteme geeignet
- max. 900 mA kombiniert auf 2 Eingänge
- DALI 2 DT8 oder Tasterdimmung
- Farbe: weiss, ~RAL 9016

inklusive Treiber

25716-024-99, S. 405

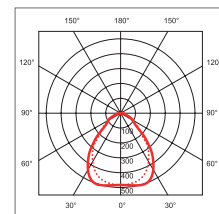
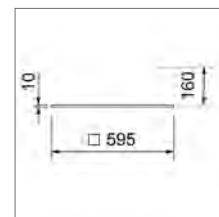

36 W

3500 – 4100 lm

2700 – 6500 K

CRI 80

Abstrahlwinkel: 80°

50'000h L70

900 mA

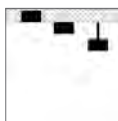
U<sub>F</sub> 33 – 38 V**Variante**

Art.-Nr.

CHF

160-060-90

299.00

**Zubehör (siehe auch Seite 222/223)**

Art.-Nr.

CHF

Seilabhangung

160-015-52

51.90

Aufbaurahmen

160-016-51

99.00

Befestigungsfeder

160-013-98

43.90

**Flat Tunable White LED Modul 625 | Deckeneinbauleuchte**

dynamische Farbtemperatur

**Informationen**

- stufenlos regulierbare Farbtemperatur von Kalt- bis Warmweiss
- homogene Ausleuchtung
- UGR <19 dank mikroprismatischem Plexiglas
- für Einbau in Deckensysteme geeignet
- max. 900 mA kombiniert auf 2 Eingänge
- DALI 2 DT8 oder Tasterdimmung
- Farbe: weiss, ~RAL 9016

inklusive Treiber

25716-024-99, S. 405

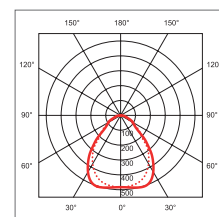
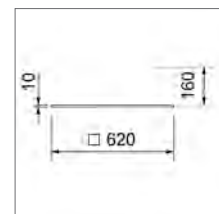

36 W

3500 – 4100 lm

2700 – 6500 K

CRI 80

Abstrahlwinkel: 80°

50'000h L70

900 mA

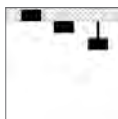
U<sub>F</sub> 33 – 38 V**Variante**

Art.-Nr.

CHF

160-062-90

299.00

**Zubehör (siehe auch Seite 222/223)**

Art.-Nr.

CHF

Seilabhangung

160-015-52

51.90

Aufbaurahmen

160-017-50

99.00

Befestigungsfeder

160-013-98

43.90

Befestigungsbugel

160-013-97

41.90





## Flat Short LED | Deckeneinbauleuchte

entblendet und effizient



### Informationen

- homogene Ausleuchtung
- UGR <19 dank mikroprismatischem Plexiglas
- für Einbau in Deckensysteme geeignet
- Deckenausschnitt in Kombination mit Spannfeder-Set: 270 – 280 x 570 – 580 mm
- Farbe: weiss, ~RAL 9016

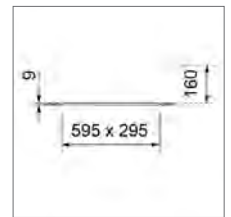

inklusive Treiber

- ▶ R/C 043-500-22, S. 399
- ▶ DALI 2 043-001-025, S. 403

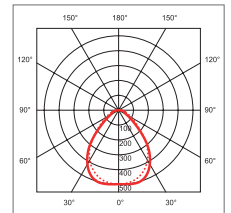

19.5 W
1900 lm, 2000 lm
3000 K, 4000 K
CRI 80
Abstrahlwinkel: 80°
50'000h L70
500 mA
U <sub>F</sub> 32 – 36 V

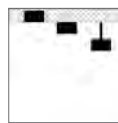

Variante	Farbtemperatur	Lichtstrom	Art.-Nr.	CHF
▶ R/C	3000 K	1900 lm	160-064-70	129.00
▶ R/C	4000 K	2000 lm	160-064-40	129.00
▶ DALI 2	3000 K	1900 lm	160-065-70	159.00
▶ DALI 2	4000 K	2000 lm	160-065-40	159.00

Zubehör (siehe auch Seite 222/223)	Art.-Nr.	CHF
Seilabhängung	160-015-52	51.90
Baldachin, inkl. Seilabhängung	160-014-51	84.00
Aufbaurahmen	160-063-91	69.00
Befestigungsfeder	160-013-96	43.90
Spannfeder-Set	160-013-95	41.90

## Flat Long LED | Deckeneinbauleuchte

entblendet und effizient



### Informationen

- homogene Ausleuchtung
- UGR <19 dank mikroprismatischem Plexiglas
- für Einbau in Deckensysteme geeignet
- Deckenausschnitt in Kombination mit Spannfeder-Set: 270 – 280 x 1170 – 1180 mm
- Farbe: weiss, ~RAL 9016

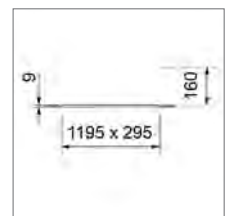

inklusive Treiber

- ▶ R/C 200-007-001, S. 400
- ▶ DALI 2 043-001-045, S. 404

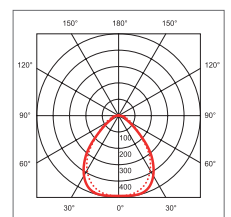

33.5 W, 34 W
3700 lm, 3900 lm
3000 K, 4000 K
CRI 80
Abstrahlwinkel: 80°
50'000h L70
900 mA
U <sub>F</sub> 32 – 36 V

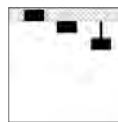

Variante	Farbtemperatur	Leistung	Lichtstrom	Art.-Nr.	CHF
<b>NEW</b> ▶ R/C	3000 K	33.5 W	3700 lm	160-057-70	189.00
<b>NEW</b> ▶ R/C	4000 K	33.5 W	3900 lm	160-057-40	189.00
▶ DALI 2	3000 K	34 W	3700 lm	160-058-70	229.00
▶ DALI 2	4000 K	34 W	3900 lm	160-058-40	229.00

Zubehör (siehe auch Seite 222/223)	Art.-Nr.	CHF
Seilabhängung	160-015-52	51.90
Baldachin, inkl. Seilabhängung	160-014-51	84.00
Aufbaurahmen	160-056-91	99.00
Befestigungsfeder	160-013-96	43.90
Spannfeder-Set	160-013-95	41.90

## Zubehör Flat

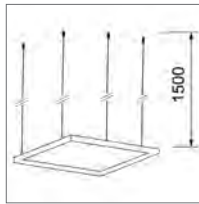
**Seilabhangung**

4 Seile, Hohre verstellbar, fur Flat LED, Flat Tunable White LED, Flat Short LED, Flat Long LED

Lange	Art.-Nr.	CHF
1500 mm	160-015-52	51.90

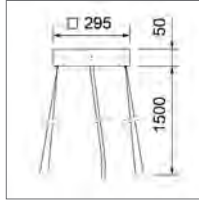
**Baldachin, inkl. Seilabhangung**

4 Seile, 1 transparentes Kabel (2 m), Hohre verstellbar, fur Flat LED, Flat Short LED, Flat Long LED

Lange	Art.-Nr.	CHF
1500 mm	160-014-51	84.00

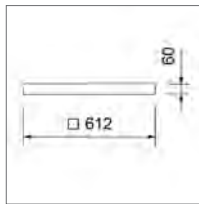
**Aufbaurahmen**

fur Flat LED (Modul 600), Flat Tunable White LED (Modul 600)

Farbe	Art.-Nr.	CHF
weiss, ~RAL 9016	160-016-51	99.00

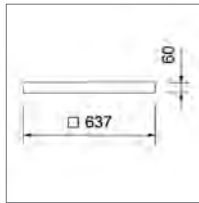
**Aufbaurahmen**

fur Flat LED (Modul 625), Flat Tunable White LED (Modul 625)

Farbe	Art.-Nr.	CHF
weiss, ~RAL 9016	160-017-50	99.00

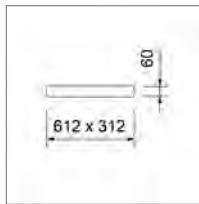
**Aufbaurahmen**

fur Flat Short LED

Farbe	Art.-Nr.	CHF
weiss, ~RAL 9016	160-063-91	69.00

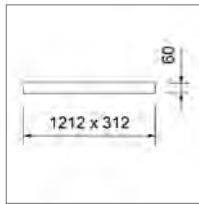
**Aufbaurahmen**

fur Flat Long LED

Farbe	Art.-Nr.	CHF
weiss, ~RAL 9016	160-056-91	99.00

## Zubehör Flat

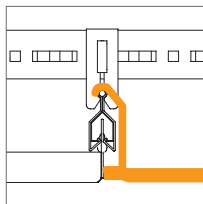
**Befestigungsfeder**

4 Stück, für Gema-Armstrong Q-Clip, für Flat LED, Flat Short LED, Flat Long LED

Variante	Art.-Nr.	CHF
	160-013-96	43.90

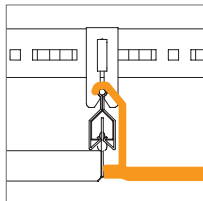
**Befestigungsfeder**

4 Stück, für Gema-Armstrong Q-Clip, für Flat Tunable White LED

Variante	Art.-Nr.	CHF
	160-013-98	43.90

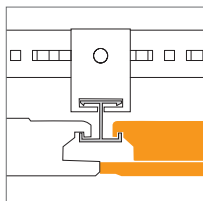
**Befestigungsbügel**

2 Stück, für Gema-Armstrong Unterkonstruktion mit H28 Profil, für Flat LED (Modul 625), Flat Tunable White LED (Modul 625)

Variante	Art.-Nr.	CHF
	160-013-97	41.90

**Spannfeder-Set**

4 Stück, für Einbau in Hohldecken geeignet, für Flat LED, Flat Short LED, Flat Long LED

Variante	Art.-Nr.	CHF
	160-013-95	41.90





## X LED | Wandeinbauleuchte

CRI  
90

NEW



## Informationen

- schönes Lichtbild
- Leuchte aus Aluminium, gebürstet
- Die Leuchte muss in das Einbaugehäuse 160-091-99 oder in ein Einbetoniergehäuse installiert werden

inklusive Treiber

 043-500-04, S. 397

Empfohlene Einbetoniergehäuse von  
AGRO AG / Kaiser (nicht für Sichtbeton geeignet):  
920 858 319

Frontring: 920 896 109

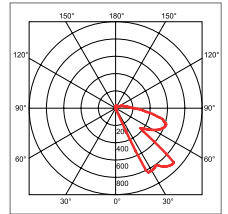
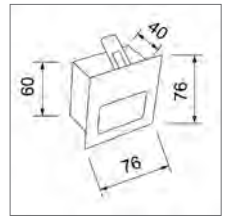

2.2 W

70 lm

3000 K

CRI 90

50'000h L70

500 mA

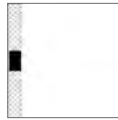
U<sub>F</sub> 2.7 – 3 V

## Variante



Art.-Nr.

160-091-70

CHF

74.00

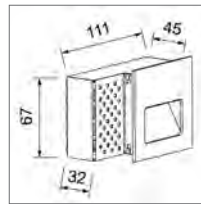

## Einbaugehäuse

geeignet für Gips- und Backsteinwände

## Variante

Art.-Nr.

160-091-99

CHF

19.90

NEW

## Frontplatte

65 x 65 mm, für Sichtbeton

## Variante

Art.-Nr.

27025-003-98

CHF

69.00

## Box Asym LED | Wandeinbauleuchte

Top in Einbau und Sichtbeton



1.2 W
20 lm
3000 K
CRI 80
Abstrahlwinkel: 90°
50'000h L70
350 mA
U <sub>e</sub> 2.8 – 3.4 V

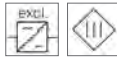

### Informationen

- IP44 von vorne
- schönes Lichtbild
- hochwertige Materialien
- einfache Montage
- geeignet für Sichtbeton
- DALI dimmbar (seriell bis 8 Stk.)
- Lochausschnitt bei Verwendung ohne Einbaugehäuse: 77 x 77 mm
- Farbe: weiss, ~RAL 9003
- Finish: strukturiert

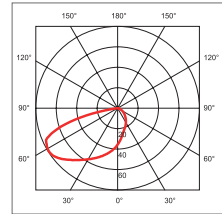
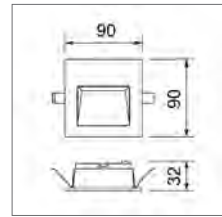

Farbtemperatur	Art.-Nr.	CHF
3000 K	160-032-71	109.00

Empfohlene Treiber	Seite	Art.-Nr.	CHF
3 W, 350 mA	396	25798-350-03	27.00
10 W, 260 – 350 mA, rund, ab 2 Leuchten	402	200-018-010	74.00

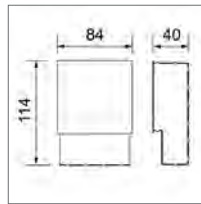

### Einbaugehäuse

geeignet für Gips- und Backsteinwände, Platz für Ein/Aus-Treiber

Variante	Art.-Nr.	CHF
	160-031-98	19.90

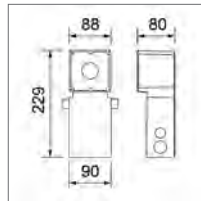

### Einbetoniergehäuse

geeignet für Sichtbeton, Platz für DALI-Treiber

Variante	Art.-Nr.	CHF
	160-031-99	51.90

## Box LED | Wandeinbauleuchte

Top in Einbau und Sichtbeton



1.2 W
90 lm
3000 K
CRI 80
Abstrahlwinkel: 90°
50'000h L70
350 mA
U <sub>F</sub> 2.8 – 3.4 V

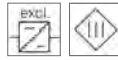
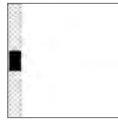

### Informationen

- IP44 von vorne
- schönes Lichtbild
- hochwertige Materialien
- einfache Montage
- geeignet für Sichtbeton
- DALI dimmbar (seriell bis 8 Stk.)
- Lochausschnitt bei Verwendung ohne Einbaugeschäse: 77 x 77 mm
- Farbe: weiss, ~RAL 9003
- Finish: strukturiert

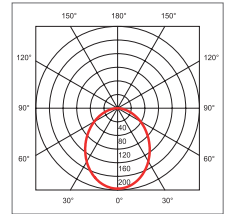
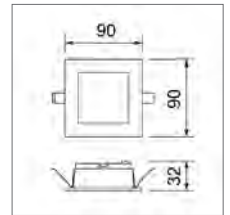

Farbtemperatur	Art.-Nr.	CHF
3000 K	160-031-71	99.00

Empfohlene Treiber	Seite	Art.-Nr.	CHF
3 W, 350 mA	396	25798-350-03	27.00
10 W, 260 – 350 mA, rund, ab 2 Leuchten	402	200-018-010	74.00

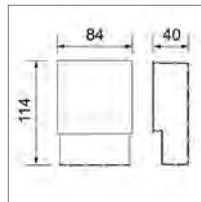

### Einbaugeschäse

geeignet für Gips- und Backsteinwände, Platz für Ein/Aus-Treiber

Variante	Art.-Nr.	CHF
	160-031-98	19.90

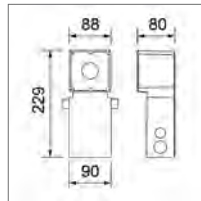

### Einbetoniergeschäse

geeignet für Sichtbeton, Platz für DALI-Treiber

Variante	Art.-Nr.	CHF
	160-031-99	51.90





**Delight II LED Ø 280 mm | Decken- und Wandaufbauleuchte**

schöne Designleuchte



14 W

1300 lm, 1400 lm

3000/4000 K switchable

CRI 80

Abstrahlwinkel: 100°

50'000h L70

350 mA

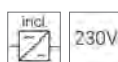
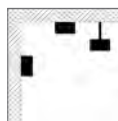
**Informationen**

- hohes Lumenpaket mit homogener Ausleuchtung
- mit Direkt-/Indirektlicht
- von 3000 auf 4000 Kelvin umschaltbar
- formschöner Alurahmen
- Farbe: weiss, ~RAL 9003
- Finish: strukturiert

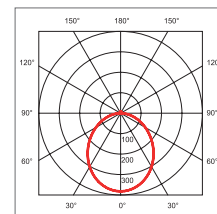
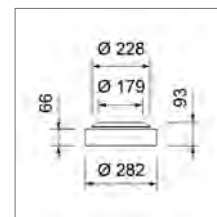

Variante	3000 K	4000 K	Art.-Nr.	CHF
	1300 lm	1400 lm	160-043-70	289.00

Zubehör	Art.-Nr.	CHF
Baldachin, inkl. Seilabhängung, 2500 mm	160-006-51	95.50

**Delight II LED Ø 380 mm | Decken- und Wandaufbauleuchte**

schöne Designleuchte



13.5 W

1490 lm, 1580 lm

3000/4000 K switchable

CRI 80

Abstrahlwinkel: 100°

50'000h L70

350 mA

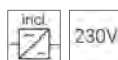
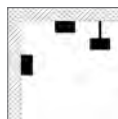
**Informationen**

- hohes Lumenpaket mit homogener Ausleuchtung
- UGR <22
- mit Direkt-/Indirektlicht
- das Indirektlicht kann mittels mitgelieferter Abdeckplatte unterbunden werden
- von 3000 auf 4000 Kelvin umschaltbar
- formschöner Alurahmen
- Farbe: weiss, ~RAL 9003
- Finish: strukturiert

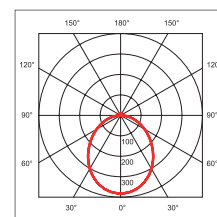
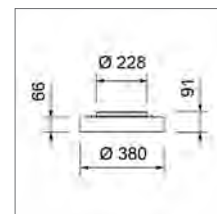

Variante	3000 K	4000 K	Art.-Nr.	CHF
	1490 lm	1580 lm	160-040-70	369.00

Zubehör	Art.-Nr.	CHF
Baldachin, inkl. Seilabhängung, 2500 mm	160-006-51	95.50



**Delight II LED Ø 600 mm | Decken- und Wandaufbauleuchte**

schöne Designleuchte

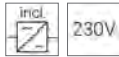
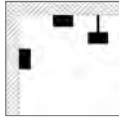

38 W  
3950 lm, 4260 lm  
3000/4000 K switchable  
CRI 80  
Abstrahlwinkel: 110°  
50'000h L70  
1000 mA

**Informationen**

- hohes Lumenpaket mit homogener Ausleuchtung
- UGR <22
- mit Direkt-/Indirektlicht
- das Indirektlicht kann mittels mitgelieferter Abdeckplatte unterbunden werden
- von 3000 auf 4000 Kelvin umschaltbar
- formschöner Alurahmen
- Farbe: weiss, ~RAL 9003
- Finish: strukturiert

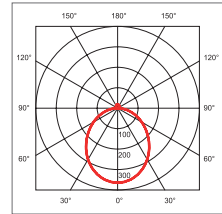
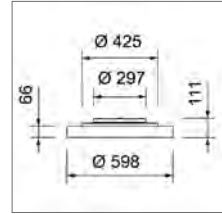

Variante	3000 K	4000 K	Art.-Nr.	CHF
	3950 lm	4260 lm	160-041-70	789.00

Optional	Art.-Nr.	CHF
----------	----------	-----

**NEW** Notlichtelement, vollautomatischer Selbsttest, 3 h UD-043-103-00 • 299.00

**NEW** Notlichtelement, vollautomatischer Selbsttest, 3 h UD-043-103-01 • 299.00

Zubehör	Art.-Nr.	CHF
Baldachin, inkl. Seilabhängung, 2500 mm	160-006-51	95.50

**Delight II LED Ø 900 mm | Decken- und Wandaufbauleuchte**

schöne Designleuchte

**NEW**

102 W  
10750 lm, 11400 lm  
3000/4000 K switchable  
CRI 80  
Abstrahlwinkel: 110°  
50'000h L70  
1400 mA

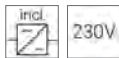
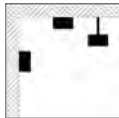
**Informationen**

- hohes Lumenpaket mit homogener Ausleuchtung
- UGR <22
- mit Direkt-/Indirektlicht
- das Indirektlicht kann mittels mitgelieferter Abdeckplatte unterbunden werden
- von 3000 auf 4000 Kelvin umschaltbar
- formschöner Alurahmen
- Farbe: weiss, ~RAL 9003
- Finish: strukturiert

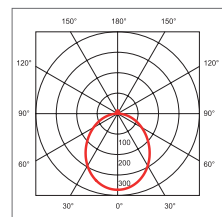
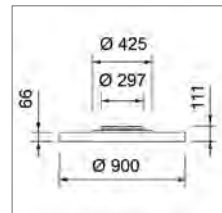

Variante	3000 K	4000 K	Art.-Nr.	CHF
	10750 lm	11400 lm	160-042-70	1599.00

Zubehör	Art.-Nr.	CHF
Baldachin, inkl. Seilabhängung, 2500 mm	160-006-51	95.50

**Delight LED | Baldachin**

inkl. Seilabhängung

**NEW****Informationen**

- 5-polige Anschlussklemme
- transparentes Kabel (3 m)
- Farbe: weiss, ~RAL 9003
- Finish: strukturiert

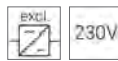
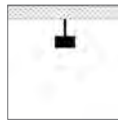
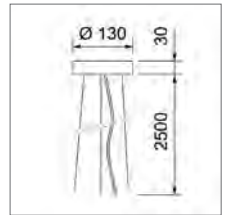

Pendellänge	Art.-Nr.	CHF
2500 mm	160-006-51	95.50





## Crono LED | Decken- und Wandaufbauleuchte

Top Technik in klassischem Design



14 W

1400 lm – 1600 lm

3000/4000 K switchable

CRI 80

Abstrahlwinkel: 120°

50'000h L70

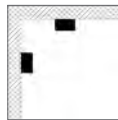

350 mA

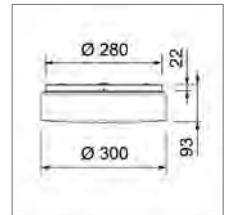

### Informationen

- randloses Design
- von 3000 auf 4000 Kelvin umschaltbar
- hohe Lichtausbeute mit mehr als 100 lm/W
- Phasenabschnitt Variante DC tauglich
- HF-Sensor-Variante:
  - Erkennungsweite 8 – 9 m
  - Erfassungswinkel 120°
  - Sensor Parameter einstellbar
  - Korridor-Funktion
- Farbe: weiss, ~RAL 9016



Variante	Art.-Nr.	CHF
 RC	160-035-70	84.00
 HF	160-036-70	139.00

Ersatzteil	Art.-Nr.	CHF
Diffusor, PMMA, opal	160-036-99	29.00

## Diamond LED Ø 300 mm | Decken- und Wandaufbauleuchte

Top Technik in klassischem Design



14.5 W  
1400 lm – 1600 lm  
3000/4000 K switchable  
CRI 80  
Abstrahlwinkel: 120°  
50'000h L70  
350 mA

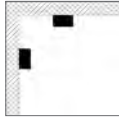

### Informationen

- randloses Design
- von 3000 auf 4000 Kelvin umschaltbar
- hohe Lichtausbeute mit mehr als 100 lm/W
- Farbe: weiss, ~RAL 9016
- Phasenabschnitt Variante DC tauglich
- HF-Sensor-Variante:
  - Erkennungsweite 8 – 9 m
  - Erfassungswinkel 120°
  - Sensor Parameter einstellbar
  - Korridor-Funktion

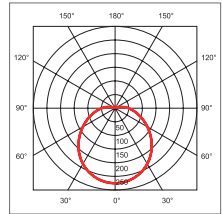
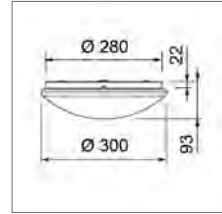

Variante	3000 K	4000 K	Art.-Nr.	CHF
 R.C.	1500 lm	1600 lm	160-021-72	84.00
 HF	1400 lm	1450 lm	160-022-70	139.00

Ersatzteil	Art.-Nr.	CHF
Diffusor, PMMA, opal	160-021-99	24.00

## Diamond LED Ø 350 mm | Decken- und Wandaufbauleuchte

Top Technik in klassischem Design



17 W, 18.5 W  
1800 lm – 2230 lm  
3000/4000 K switchable  
CRI 80  
Abstrahlwinkel: 120°  
50'000h L70  
500 mA

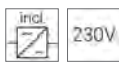
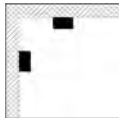

### Informationen

- randloses Design
- von 3000 auf 4000 Kelvin umschaltbar
- hohe Lichtausbeute mit mehr als 100 lm/W
- Farbe: weiss, ~RAL 9016
- Phasenabschnitt Variante DC tauglich
- HF-Sensor-Variante:
  - Erkennungsweite 8 – 9 m
  - Erfassungswinkel 120°
  - Sensor Parameter einstellbar
  - Korridor-Funktion

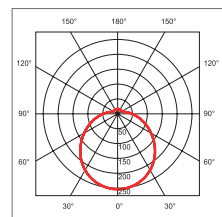
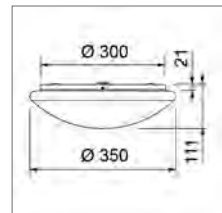

Variante	Leistung	3000 K	4000 K	Art.-Nr.	CHF
 R.C.	18.5 W	2100 lm	2230 lm	160-024-72	94.00
 DALI 2	18.5 W	2100 lm	2230 lm	160-026-72	• 199.00
 HF	17 W	1800 lm	1900 lm	160-025-70	149.00

Ersatzteil	Art.-Nr.	CHF
Diffusor, PMMA, opal	160-024-99	27.00

## Diamond LED Ø 350 mm, E27 | Decken- und Wandaufbauleuchte

Top Technik in klassischem Design



### Informationen

- randloses Design
- Lampenfassung E27
- max. 1 x 15 W (LED)
- Farbe: weiss, ~RAL 9016

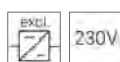
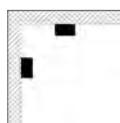
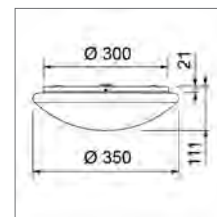

Variante	Art.-Nr.	CHF
	160-024-00	42.00

Leuchtmittelempfehlung	Lichtsteuerung	Seite
Philips Classic LED		197

Ersatzteil	Art.-Nr.	CHF
Diffusor, PMMA, opal	160-024-99	27.00

## Diamond LED Ø 400 mm | Decken- und Wandaufbauleuchte

Top Technik in klassischem Design



### Informationen

- randloses Design
- von 3000 auf 4000 Kelvin umschaltbar
- hohe Lichtausbeute mit mehr als 100 lm/W
- Farbe: weiss, ~RAL 9016
- Phasenabschnitt Variante DC tauglich
- HF-Sensor-Variante:
  - Erkennungsweite 8 – 9 m
  - Erfassungswinkel 120°
  - Sensor Parameter einstellbar
  - Korridor-Funktion
- Not-Variante: 3h Brenndauer und Selbsttest

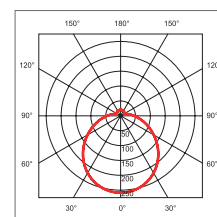
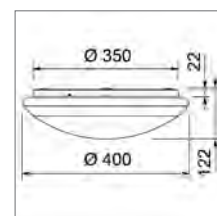

20 W – 23 W
2100 lm – 2550 lm
3000/4000 K switchable
CRI 80
Abstrahlwinkel: 120°
50'000h L70
500 mA

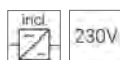
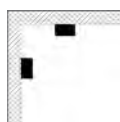

Variante	Leistung	3000 K	4000 K	EEK	Art.-Nr.	CHF
	21.5 W	2400 lm	2550 lm	C	160-027-72	104.00
	21.5 W	2400 lm	2550 lm	D	160-037-72	209.00
	20 W	2100 lm	2200 lm	C	160-028-70	159.00
	22 W	2400 lm	2550 lm	C	160-029-72	299.00

Ersatzteil	Art.-Nr.	CHF
Diffusor, PMMA, opal	160-027-99	29.00
Akku-Pack, LiFePO4 3.2V 4.5Ah, ta max. 60°	211-001-000	54.00





## Lago LED Ø 220 mm | Decken- und Wandaufbauleuchte

NEW

harmonisch in Licht und Design



### Informationen

- geringe Aufbauhöhe
- randloses Design
- von 3000 auf 4000 Kelvin umschaltbar
- hohe Lichtausbeute mit 100 lm/W
- einfache und schnelle Installation
- Farbe: weiss, ~RAL 9016

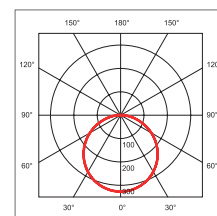

11 W  
1100 lm, 1150 lm  
3000/4000 K switchable  
CRI 80  
Abstrahlwinkel: 120°  
50'000h L70



Variante	3000 K	4000 K	Art.-Nr.	CHF
	1100 lm	1150 lm	160-110-70	89.00

## Lago LED Ø 275 mm | Decken- und Wandaufbauleuchte

NEW

harmonisch in Licht und Design



### Informationen

- geringe Aufbauhöhe
- randloses Design
- von 3000 auf 4000 Kelvin umschaltbar
- hohe Lichtausbeute mit 100 lm/W
- einfache und schnelle Installation
- Farbe: weiss, ~RAL 9016
- HF-Sensor-Variante:
  - Erkennungsweite 5 – 7 m
  - Erfassungswinkel 140°
  - Sensor Parameter einstellbar

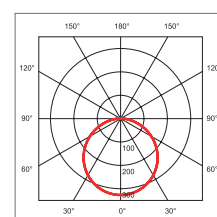

16.5 W, 17.5 W  
1700 lm, 1800 lm, 1900 lm  
3000/4000 K switchable  
CRI 80  
Abstrahlwinkel: 120°  
50'000h L70



Variante	Leistung	3000 K	4000 K	Art.-Nr.	CHF
	16.5 W	1700 lm	1800 lm	160-111-70	119.00
	17.5 W	1800 lm	1900 lm	160-112-70	159.00
	17.5 W	1800 lm	1900 lm	160-113-70	149.00



## Lago LED Ø 275 mm, Not-Variante | Decken- und Wandaufbauleuchte

NEW

harmonisch in Licht und Design



### Informationen

- geringe Aufbauhöhe
- randloses Design
- von 3000 auf 4000 Kelvin umschaltbar
- hohe Lichtausbeute mit 100 lm/W
- Auto Test und Manueller Test
- Einzelbatterie für 3h Brenndauer (Lichtstrom 20 – 25 %)
- Kontroll-LED integriert

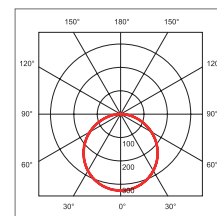
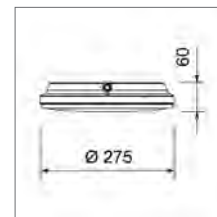

19 W  
1800 lm, 1900 lm  
3000/4000 K switchable  
CRI 80  
Abstrahlwinkel: 120°  
50'000h L70



Variante	Leistung	3000 K	4000 K	Art.-Nr.	CHF
	19 W	1800 lm	1900 lm	160-114-70	199.00

## Lago LED Ø 350 mm | Decken- und Wandaufbauleuchte

NEW

harmonisch in Licht und Design

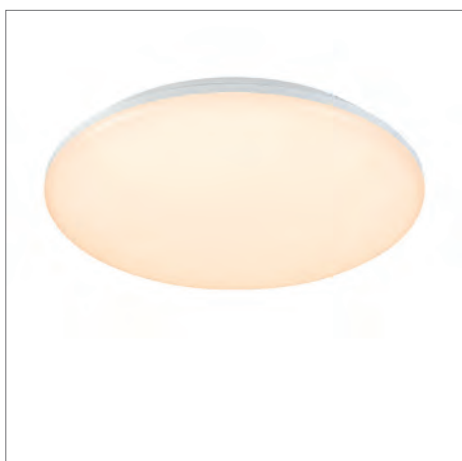

### Informationen

- geringe Aufbauhöhe
- randloses Design
- von 3000 auf 4000 Kelvin umschaltbar
- hohe Lichtausbeute mit 110 lm/W
- einfache und schnelle Installation
- Farbe: weiss, ~RAL 9016
- HF-Sensor-Variante:
  - Erkennungsweite 5 – 7 m
  - Erfassungswinkel 140°
  - Sensor Parameter einstellbar

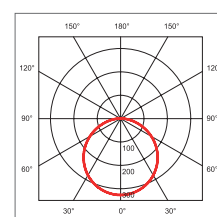
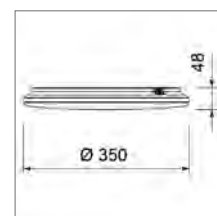

23.5 W, 24.5 W  
2500 lm, 2600 lm, 2700 lm  
3000/4000 K switchable  
CRI 80  
Abstrahlwinkel: 120°  
50'000h L70



Variante	Leistung	3000 K	4000 K	Art.-Nr.	CHF
	23.5 W	2500 lm	2600 lm	160-115-70	159.00
	24.5 W	2600 lm	2700 lm	160-116-70	199.00
	24.5 W	2600 lm	2700 lm	160-117-70	189.00





**Cloud LED Ø 200 mm | Decken- und Wandaufbauleuchte**

flach, effizient, schön



9 W

900 lm

3000 K

CRI 80

Abstrahlwinkel: 120°

40'000h L70

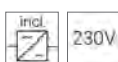
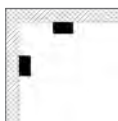
**Informationen**

- geringe Aufbauhöhe
- rückseitige Kabelzuführung oder Aufputz
- Farbe: weiss

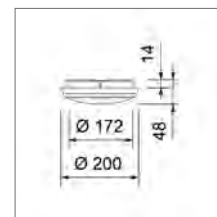
**Variante**

Art.-Nr.

CHF



30246-001-72

69.00

**Cloud LED Ø 250 mm | Decken- und Wandaufbauleuchte**

flach, effizient, schön



11.5 W

1150 lm

3000 K

CRI 80

Abstrahlwinkel: 120°

40'000h L70

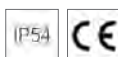
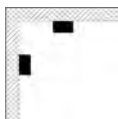
**Informationen**

- geringe Aufbauhöhe
- rückseitige Kabelzuführung oder Aufputz
- HF-Sensor-Variante:
  - Erkennungsweite 5 – 7 m
  - Erfassungswinkel 140°
  - Sensor Parameter einstellbar
- Not-Variante:
  - mit Einzelbatterie für Bereitschaftsbetrieb
  - 3h Brenndauer (Lichtstrom 20 – 25 %)
  - Kontroll-LED integriert
- Farbe: weiss

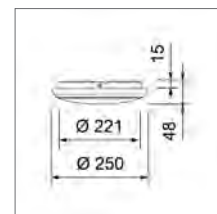
**Variante**

IP Schutzart

Art.-Nr.

CHF



IP54

30246-005-71

79.00



IP20

30246-030-71

129.00



IP20

30246-031-71

149.00

**Deko-Ring**

Edelstahl, gebürstet

**Variante**

Art.-Nr.

CHF

30246-250-01

19.90

## Cloud LED Ø 300 mm | Decken- und Wandaufbauleuchte

flach, effizient, schön



14 W  
1450 lm, 1500 lm  
3000 K, 4000 K  
CRI 80  
Abstrahlwinkel: 120°  
40'000h L70

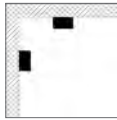

### Informationen

- geringe Aufbauhöhe
- rückseitige Kabelzuführung oder Aufputz
- Farbe: weiss

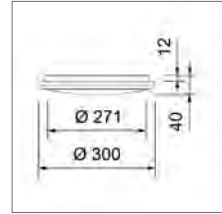

Variante	Farbtemperatur	Lichtstrom	EEK	Art.-Nr.	CHF
	3000 K	1450 lm	D	30246-002-71	99.00
	4000 K	1500 lm	C	30246-002-41	99.00



### Deko-Ring

Edelstahl, gebürstet

Variante	Art.-Nr.	CHF
	30246-300-01	19.90

## Cloud LED Ø 300 mm | Decken- und Wandaufbauleuchte

Sensor- und Not-Varianten



14 W  
1450 lm, 1500 lm  
3000 K, 4000 K  
CRI 80  
Abstrahlwinkel: 120°  
40'000h L70

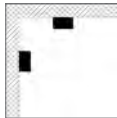

### Informationen

- geringe Aufbauhöhe
- rückseitige Kabelzuführung oder Aufputz
- HF-Sensor-Variante:
  - Erkennungsweite 5 – 7 m
  - Erfassungswinkel 140°
  - Sensor Parameter einstellbar
- Not-Variante:
  - mit Einzelbatterie für Bereitschaftsbetrieb
  - 3h Brenndauer (Lichtstrom 20 – 25 %)
  - Kontroll-LED integriert
- Farbe: weiss

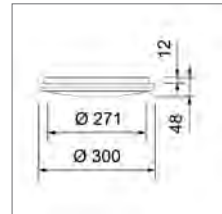

Variante	Farbtemperatur	Lichtstrom	IP Schutzart	EEK	Art.-Nr.	CHF
	3000 K	1450 lm	IP20	D	30246-020-71	149.00
	3000 K	1450 lm	IP54	D	30246-021-71	179.00
	4000 K	1500 lm	IP54	C	30246-021-41	179.00
	3000 K	1450 lm	IP20	D	30246-022-71	199.00

**Cloud LED Ø 350 mm | Decken- und Wandaufbauleuchte**

flach, effizient, schön

**Informationen**

- geringe Aufbauhöhe
- rückseitige Kabelzuführung oder Aufputz
- Farbe: weiss

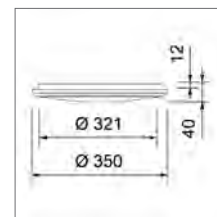

20 W

2000 lm

3000 K

CRI 80

Abstrahlwinkel: 120°

40'000h L70

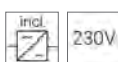
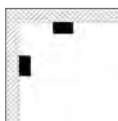

Variante

Art.-Nr.

CHF



30246-003-71

139.00

**Cloud LED Ø 400 mm | Decken- und Wandaufbauleuchte**

flach, effizient, schön

**Informationen**

- geringe Aufbauhöhe
- rückseitige Kabelzuführung oder Aufputz
- Farbe: weiss

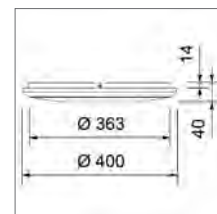

23 W

2300 lm

3000 K

CRI 80

Abstrahlwinkel: 120°

40'000h L70

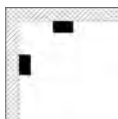

Variante

Art.-Nr.

CHF



30246-004-71

169.00



## Takeo Round LED Ø 115 mm | Decken- und Wandaufbauleuchte

NEW

Klare Form in Aluminium

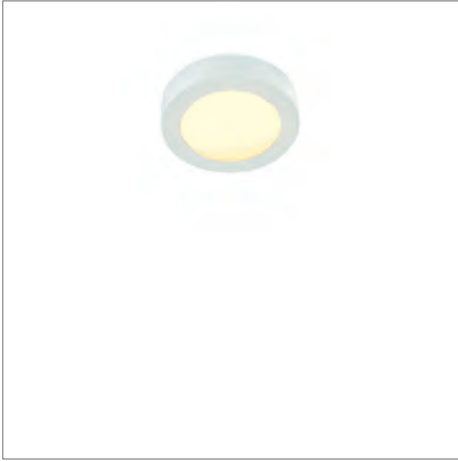

### Informationen

- geringe Aufbauhöhe
- homogenes Licht
- Farbe: weiss

passend zu  
Einbau-Downlight Takeo Round LED, S. 168

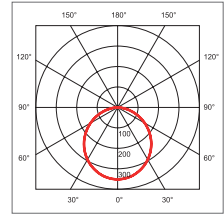
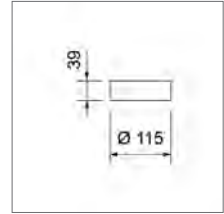

7 W
550 lm
3000 K
CRI 80
Abstrahlwinkel: 110°
50'000h L70
500 mA
U <sub>F</sub> 11 – 13 V

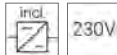
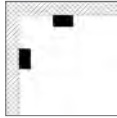

### Variante



### Art.-Nr.

### CHF

23943-001-71	149.00
23943-018-72	• 254.00

## Takeo Round LED Ø 180 mm | Decken- und Wandaufbauleuchte

NEW

Klare Form in Aluminium



### Informationen

- geringe Aufbauhöhe
- homogenes Licht
- Farbe: weiss

passend zu  
Einbau-Downlight Takeo Round LED, S. 168

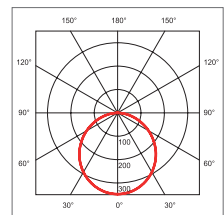
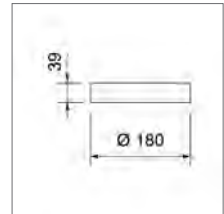

10 W
840 lm
3000 K
CRI 80
Abstrahlwinkel: 110°
50'000h L70
500 mA
U <sub>F</sub> 14 – 19 V

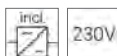
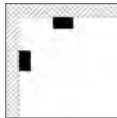

### Variante



### Art.-Nr.

### CHF

23943-002-71	169.00
23943-019-71	• 254.00
23943-020-72	• 274.00

**Takeo Round LED Ø 240 mm | Decken- und Wandaufbauleuchte****NEW**

Klare Form in Aluminium

**Informationen**

- geringe Aufbauhöhe
- homogenes Licht
- Farbe: weiss

passend zu

Einbau-Downlight Takeo Round LED, S. 168

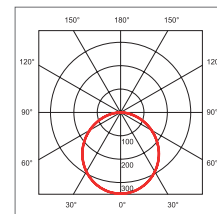
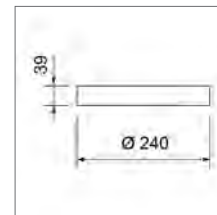

13 W

1200 lm

3000 K

CRI 80

Abstrahlwinkel: 110°

50'000h L70

500 mA

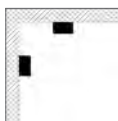
U<sub>F</sub> 23 – 25 V**Variante**

Art.-Nr.

CHF



23943-003-71

209.00



23943-022-71

• 319.00



23943-024-71

• 399.00

**Takeo Round LED Ø 300 mm | Decken- und Wandaufbauleuchte****NEW**

Klare Form in Aluminium

**Informationen**

- geringe Aufbauhöhe
- homogenes Licht
- Farbe: weiss

passend zu

Einbau-Downlight Takeo Round LED, S. 168

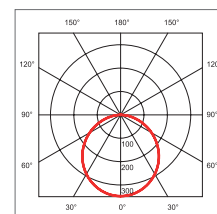
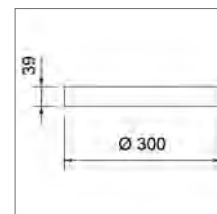

28 W

2500 lm

3000 K

CRI 80

Abstrahlwinkel: 110°

50'000h L70

700 mA

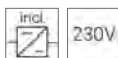
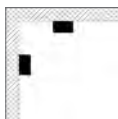
U<sub>F</sub> 35 – 37 V**Variante**

Art.-Nr.

CHF



23943-004-71

319.00



23943-028-71

• 399.00



23943-030-71

• 429.00



23943-032-71

• 499.00

## Takeo Square LED □ 108 mm | Decken- und Wandaufbauleuchte

NEW

Klare Form in Aluminium



### Informationen

- geringe Aufbauhöhe
- homogenes Licht
- Farbe: weiss

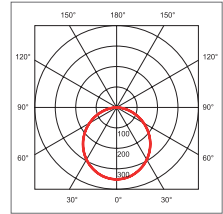
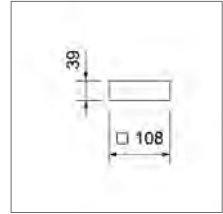

7 W  
430 lm  
3000 K  
CRI 80  
Abstrahlwinkel: 110°  
50'000h L70  
500 mA  
U<sub>F</sub> 11 – 13 V

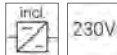
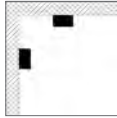

### Variante



### Art.-Nr.

### CHF

23943-005-71 149.00  
23943-017-72 • 254.00

## Takeo Square LED □ 168 mm | Decken- und Wandaufbauleuchte

NEW

Klare Form in Aluminium



### Informationen

- geringe Aufbauhöhe
- homogenes Licht
- Farbe: weiss

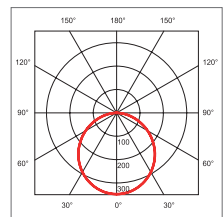
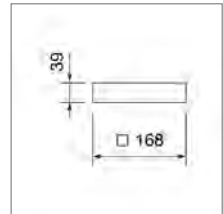

13 W  
960 lm  
3000 K  
CRI 80  
Abstrahlwinkel: 110°  
50'000h L70  
500 mA  
U<sub>F</sub> 23 – 25 V

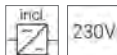
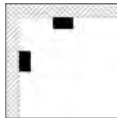

### Variante



### Art.-Nr.

### CHF

23943-006-71 209.00  
23943-021-71 • 319.00  
23943-023-71 • 399.00

## Takeo Square LED □ 220 mm | Decken- und Wandaufbauleuchte

Klare Form in Aluminium



### Informationen

- geringe Aufbauhöhe
- homogenes Licht
- Farbe: weiss

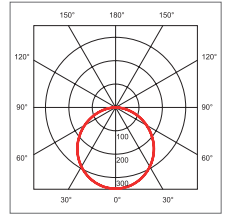
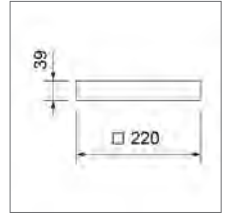

22 W

1490 lm

3000 K

CRI 80

Abstrahlwinkel: 110°

50'000h L70

700 mA

U<sub>F</sub> 23 – 25 V

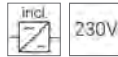
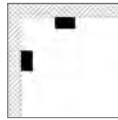

### Variante



Art.-Nr.

CHF

23943-007-70 264.00

23943-025-70 • 374.00

23943-026-70 • 459.00

## Takeo Square LED □ 300 mm | Decken- und Wandaufbauleuchte

Klare Form in Aluminium



### Informationen

- geringe Aufbauhöhe
- homogenes Licht
- Farbe: weiss

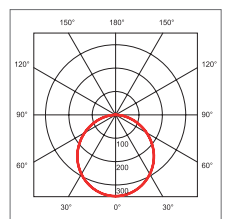
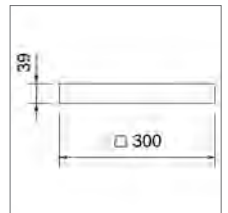

30 W

1960 lm

3000 K

CRI 80

Abstrahlwinkel: 110°

50'000h L70

1000 mA

U<sub>F</sub> 23 – 25 V

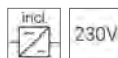
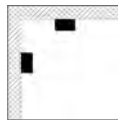

### Variante

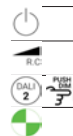

Art.-Nr.

CHF

23943-008-70 319.00

23943-027-70 • 399.00

23943-029-70 • 429.00

23943-031-70 • 499.00





**Culina LED | Decken- und Wandaufbauleuchte**

die schlichte Grundbeleuchtung

**NEW**

19 – 40 W

2100 – 4400 lm

3000/4000 K switchable

CRI 80

Abstrahlwinkel: 120°

50'000h L70

500 – 1000 mA

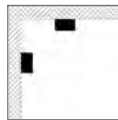
**Informationen**

- variables Lumenpaket
- von 3000 auf 4000 Kelvin umschaltbar
- universell einsetzbar
- Einspeisung stirnseitig oder von oben
- einfache Montage
- Ersatz für Leuchten mit konventionellen Leuchtstoffröhren

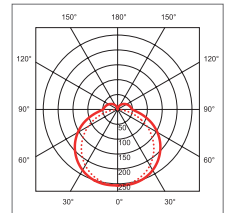
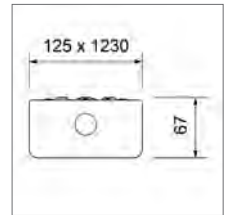

Variante



Art.-Nr.

160-055-70

CHF

149.00

**DIP Switch Position**

$I_{out}$	P	Lumen	1	2
500 mA	19 W	2100 – 2200 lm	-	-
700 mA	27 W	2900 – 3000 lm	ON	-
800 mA	31 W	3300 – 3400 lm	-	ON
1000 mA	40 W	4200 – 4400 lm	ON	ON

## Modul 8 | Decken- und Wandaufbauleuchte

Design in Aluminium



### Informationen

- klare und schöne Linie
- homogenes Licht
- einfache Montage
- 1-10V auf Anfrage
- andere Längen auf Anfrage
- Aufpreis Farben (RAL/NCS) bis 1.5 m: 49.90 CHF (>1.5 m auf Anfrage)

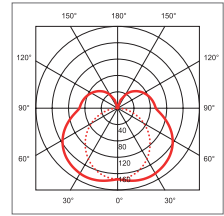
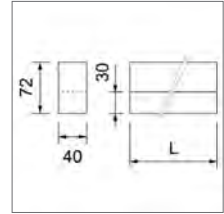

12 W, 18 W, 27 W, 36 W, 45 W  
 900 – 3250 lm  
 3000 K  
 CRI 90  
 Abstrahlwinkel: 160°  
 50'000h L70

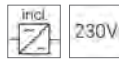
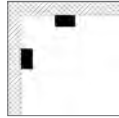

Variante	Länge	Leistung	Lichtstrom	Art.-Nr.	CHF
1	400 mm	12 W	900 lm	161-010-70	• 329.00
2	600 mm	18 W	1300 lm	161-011-71	• 379.00
3	900 mm	27 W	1950 lm	161-012-71	• 465.00
4	1200 mm	36 W	2600 lm	161-013-71	• 515.00
5	1500 mm	45 W	3250 lm	161-014-71	• 535.00

Optional für 1200/1500 mm Art.-Nr. CHF

<b>NEW</b>	Notlichtelement, vollautomatischer Selbsttest, 3 h	UD-211-002-200	• 299.00
------------	--	----------------	----------



## Modul 8 Flat | Decken- und Wandaufbauleuchte

Design in Aluminium



12 W, 18 W, 27 W, 36 W, 45 W  
 900 – 3250 lm  
 3000 K  
 CRI 90  
 Abstrahlwinkel: 160°  
 50°000h L70

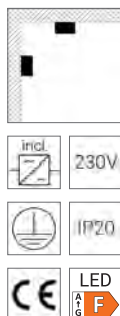

### Informationen

- klare und schöne Linie
- homogenes Licht
- einfache Montage
- 1-10V auf Anfrage
- andere Längen auf Anfrage
- Aufpreis Farben (RAL/NCS) bis 1.5 m:  
67.00 CHF (>1.5 m auf Anfrage)

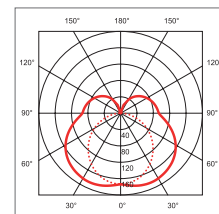
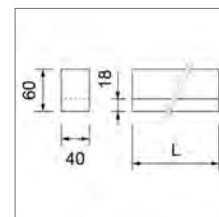

Variante	Länge	Leistung	Lichtstrom	Art.-Nr.	CHF
	400 mm	12 W	900 lm	161-015-70	• 329.00
	600 mm	18 W	1300 lm	161-016-71	• 379.00
	900 mm	27 W	1950 lm	161-017-71	• 465.00
	1200 mm	36 W	2600 lm	161-018-71	• 515.00
	1500 mm	45 W	3250 lm	161-019-71	• 535.00

Optional für 1200/1500 mm	Art.-Nr.	CHF
<b>NEW</b> Notlichtelement, vollautomatischer Selbsttest, 3 h	UD-211-002-200	• 299.00

## Modul 8 Round | Decken- und Wandaufbauleuchte

Design in Aluminium



12 W, 18 W, 27 W, 36 W, 45 W  
 900 – 3250 lm  
 3000 K  
 CRI 90  
 Abstrahlwinkel: 160°  
 50°000h L70

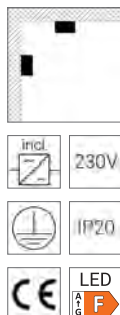

### Informationen

- klare und schöne Linie
- homogenes Licht
- einfache Montage
- 1-10V auf Anfrage
- andere Längen auf Anfrage
- Aufpreis Farben (RAL/NCS) bis 1.5 m:  
49.90 CHF (>1.5 m auf Anfrage)

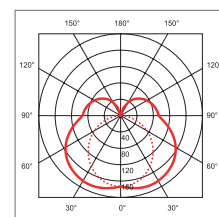
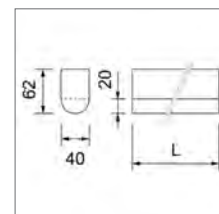

Variante	Länge	Leistung	Lichtstrom	Art.-Nr.	CHF
	400 mm	12 W	900 lm	161-034-70	• 329.00
	600 mm	18 W	1300 lm	161-035-70	• 379.00
	900 mm	27 W	1950 lm	161-036-70	• 465.00
	1200 mm	36 W	2600 lm	161-037-70	• 515.00
	1500 mm	45 W	3250 lm	161-038-70	• 535.00

Optional für 1200/1500 mm	Art.-Nr.	CHF
<b>NEW</b> Notlichtelement, vollautomatischer Selbsttest, 3 h	UD-211-002-200	• 299.00





# Modular | Decken- und Wandaufbauleuchte

schlanke Direkt/Indirekt-Beleuchtung



### Informationen

- klare und schöne Linie
- homogenes Licht
- 2-seitiger Lichtaustritt
- Kabeleinlass in der Mitte, Ø 8 mm
- 1-10V auf Anfrage
- andere Längen auf Anfrage
- Aufpreis Farben (RAL/NCS) bis 1.5 m: 67.00 CHF (>1.5 m auf Anfrage)

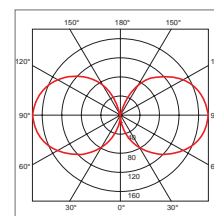
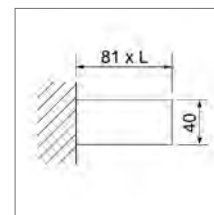

21 W, 33 W, 45 W, 58 W  
 2 x 800 – 2 x 2050 lm  
 3000 K  
 CRI 90  
 Abstrahlwinkel: 2 x 120°  
 50'000h L70

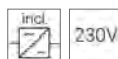
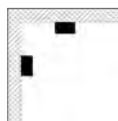

Variante	Länge	Leistung	Lichtstrom	Art.-Nr.	CHF
2	600 mm	21 W	2 x 800 lm	161-001-71	• 379.00
2	900 mm	33 W	2 x 1230 lm	161-002-71	• 465.00
2	1200 mm	45 W	2 x 1640 lm	161-003-71	• 515.00
2	1500 mm	58 W	2 x 2050 lm	161-004-71	• 599.00

Optional für 1200/1500 mm	Art.-Nr.	CHF
<b>NEW</b> 2 Notlichtelement, vollautomatischer Selbsttest, 3 h	UD-211-002-200	• 299.00





## Side | Decken- und Wandaufbauleuchte

Setz Sie und Ihren Spiegel passgenau in Szene



8 W, 11 W, 17 W, 23 W, 29 W  
540 – 2050 lm  
3000 K  
CRI 90  
Abstrahlwinkel: 160°  
50'000h L70

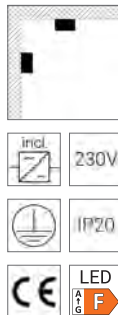

### Informationen

- schöne und eigenständige Form
- angenehme Lichtfarbe mit homogener Lichtverteilung
- Kabeleinlass in der Mitte, Ø 8 mm
- 1-10V auf Anfrage
- andere Längen auf Anfrage
- Aufpreis Farben (RAL/NCS) bis 1.5 m: 67.00 CHF (>1.5 m auf Anfrage)

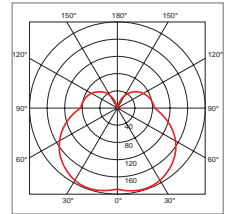
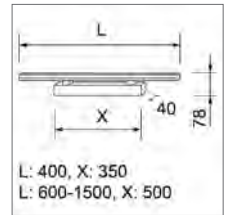

Variante	Länge	Leistung	Lichtstrom	Art.-Nr.	CHF
	400 mm	8 W	540 lm	161-020-71	• 329.00
	600 mm	11 W	820 lm	161-021-71	• 379.00
	900 mm	17 W	1230 lm	161-022-71	• 429.00
	1200 mm	23 W	1640 lm	161-023-71	• 485.00
	1500 mm	29 W	2050 lm	161-024-71	• 535.00

## Side Round | Decken- und Wandaufbauleuchte

Setz Sie und Ihren Spiegel passgenau in Szene



8 W, 11 W, 17 W, 23 W, 29 W  
570 – 2150 lm  
3000 K  
CRI 90  
Abstrahlwinkel: 160°  
50'000h L70

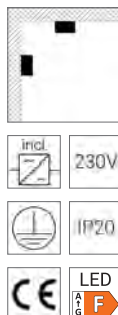

### Informationen

- schöne und eigenständige Form
- angenehme Lichtfarbe mit homogener Lichtverteilung
- Kabeleinlass in der Mitte, Ø 8 mm
- 1-10V auf Anfrage
- andere Längen auf Anfrage
- Aufpreis Farben (RAL/NCS) bis 1.5 m: 67.00 CHF (>1.5 m auf Anfrage)

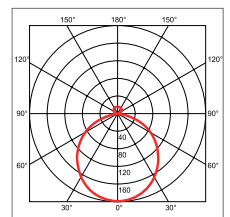

Variante	Länge	Leistung	Lichtstrom	Art.-Nr.	CHF
	400 mm	8 W	570 lm	161-039-70	• 329.00
	600 mm	11 W	860 lm	161-040-70	• 379.00
	900 mm	17 W	1290 lm	161-041-70	• 429.00
	1200 mm	23 W	1720 lm	161-042-70	• 485.00
	1500 mm	29 W	2150 lm	161-043-70	• 535.00





## Single LED | Decken- und Wandaufbauleuchte

Schlicht richtbar



### Informationen

- ohne Leuchtmittel GU10
- max. 1 x 10 W (LED)
- Farbe: weiss, ~RAL 9016

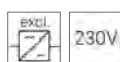
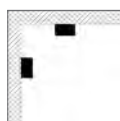
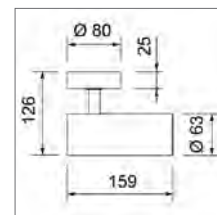

Variante	Art.-Nr.	CHF
	160-001-50	99.00

Leuchtmittlempfehlung	Lichtsteuerung	Seite
RIDL 7 GU10		189
Unex Lamp GU10		196

## Twin LED | Decken- und Wandaufbauleuchte

Schlicht richtbar



### Informationen

- ohne Leuchtmittel GU10
- max. 2 x 10 W (LED)
- Farbe: weiss, ~RAL 9016

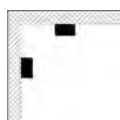
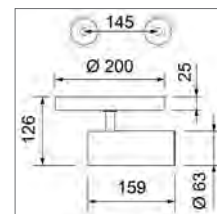

Variante	Art.-Nr.	CHF
	160-002-50	144.00

Leuchtmittlempfehlung	Lichtsteuerung	Seite
RIDL 7 GU10		189
Unex Lamp GU10		196



**Walo LED | Wandaufbauleuchte**

schlichte Eleganz

**NEW****Informationen**

- inkl. GU10 Keramikfassung
- ohne Leuchtmittel GU10
- max. 2 x 10 W (LED)
- Leuchtmittel gut entblendet (zurückversetzt)
- eine Haltefeder sichert das Leuchtmittel
- hochwertige Wandaufbauleuchte aus Aluminium

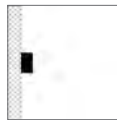
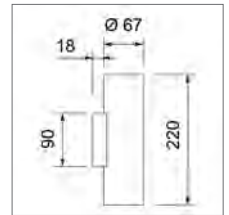

Variante	Art.-Nr.	CHF
weiss, strukturiert, ~RAL9003	160-092-50	99.00
schwarz, strukturiert, ~RAL9004	160-093-50	99.00
alu-gebürstet	160-094-50	99.00

Leuchtmittlempfehlung	Lichtsteuerung	Seite
Unex Lamp GU10		196





**Lim LED | Wandaufbauleuchte**

Klassisch schön

CRI  
90**Informationen**

- dekorativer Lichteffect
- Leuchte aus Aluminium

passend zu  
Wandaufbauleuchte Lim Outdoor, S. 349  
Pollerleuchte Lim LED, S. 379

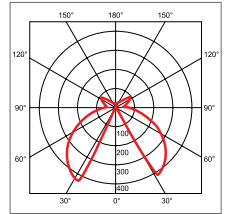
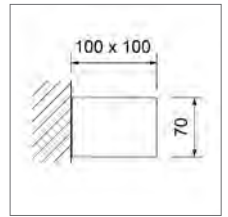

5 W, 6 W

400 lm, 450 lm

3000 K

CRI 90

Abstrahlwinkel: 110°

40'000h L70

500 mA

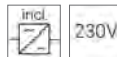

Variante	Leistung	Lichtstrom	Farbe/Finish	EEK	Art.-Nr.	CHF
↙ R/C	6 W	450 lm	weiss, strukturiert, ~RAL 9003	E	116-004-72	209.00
↙ R/C	5 W	400 lm	alu-glänzend	-	116-005-71	209.00

**Lim L LED | Wandaufbauleuchte**

Klare Linie

CRI  
90**Informationen**

- dekorativer Lichteffect
- Leuchte aus Aluminium

passend zu  
Wandaufbauleuchte Lim Outdoor, S. 349  
Pollerleuchte Lim LED, S. 379

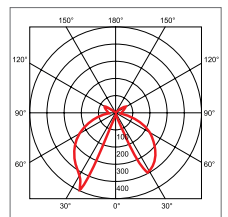
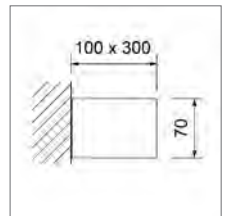

10 W, 10.5 W

640 lm, 930 lm

3000 K

CRI 90

Abstrahlwinkel: 120°

40'000h L70

500 mA

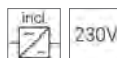

Variante	Leistung	Lichtstrom	Farbe/Finish	EEK	Art.-Nr.	CHF
↙ R/C	10.5 W	930 lm	weiss, ~RAL 9003	E	116-051-71	289.00
↙ R/C	10 W	640 lm	alu-glänzend	-	116-052-70	289.00





**Asimo LED | Wandaufbauleuchte**

klares Design mit Asymmetrie

**Informationen**

- schönes und flaches Design
- angenehmes Licht durch mikroprismatischer Diffusor
- asymmetrischer Lichtaustritt
- DALI / PushDim
- einfache Montage
- Farbe: weiss, ~RAL 9016
- Finish: strukturiert

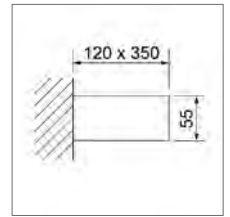

passend zu  
Stehleuchte Asimo LED, S. 279

20 W

1700 lm, 1850 lm

3000 K, 4000 K

CRI 80

50'000h L70

500 mA

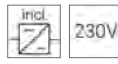
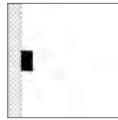

Variante	Farbtemperatur	Lichtstrom	Art.-Nr.	CHF
	3000 K	1700 lm	160-007-70	334.00
	4000 K	1850 lm	160-007-40	334.00

**Climb LED | Wandaufbauleuchte**

die Asymmetrie Waffe

**Informationen**

- klares Design
- asymmetrischer Lichtaustritt
- 30° schwenkbar (2 x 15°)
- einfache Montage
- Farbe: weiss, ~RAL 9003
- Finish: strukturiert

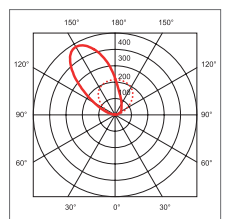
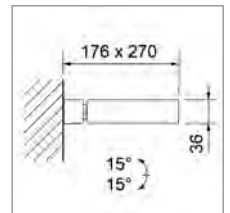

34 W

2950 lm, 3200 lm

3000 K, 4000 K

CRI 80

Abstrahlwinkel: 75°

50'000h L70

500 mA

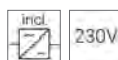
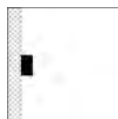

Variante	Farbtemperatur	Lichtstrom	EEK	Art.-Nr.	CHF
	3000 K	2950 lm	E	160-033-70	369.00
	4000 K	3200 lm	D	160-033-40	369.00





## Shi LED | Wandaufbauleuchte

CRI 90



### Informationen

- schöne und eigenständige Form
- Farben auf Wunsch

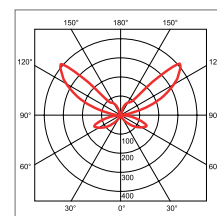
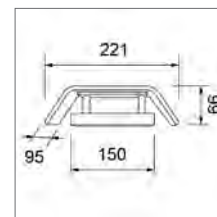

10 W  
620 lm  
3000 K  
CRI 90  
30'000h L70  
500 mA

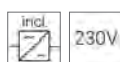
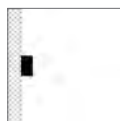

Variante	Farbe	Art.-Nr.	CHF
▲ R/C	weiss, ~RAL 9003	116-056-70	199.00
▲ R/C	alu-glänzend	116-057-70	199.00

## Trina LED | Wandaufbauleuchte

dezentres Kraftpaket



### Informationen

- minimalistisches Design mit starkem Lumenpaket
- Farbe: weiss, ~RAL 9016

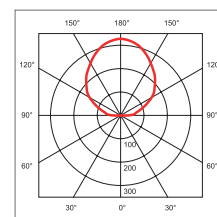
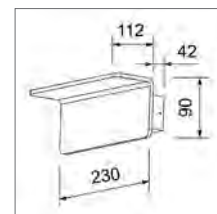

17 W  
1700 lm  
3000 K  
CRI 80  
Abstrahlwinkel: 120°  
40'000h L70

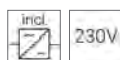
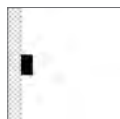

Variante	Art.-Nr.	CHF
▲ R/C	116-047-70	229.00





## Blade | Wandaufbauleuchte

Direkt/indirekt mit integriertem Treiber

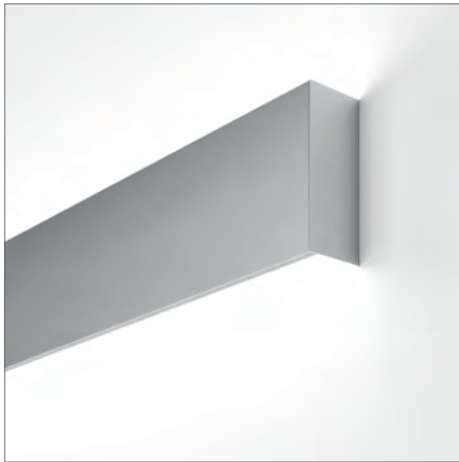

24 W, 36 W, 47 W  
1340 lm, 2000 lm, 2670 lm  
3000 K  
CRI 90  
Abstrahlwinkel: 120°  
50'000h L70

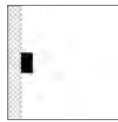

### Informationen

- 2-seitiger Lichtaustritt
- Treiber integriert
- für horizontale oder vertikale Montage
- 1-10V auf Anfrage
- andere Längen auf Anfrage
- Aufpreis Farben (RAL/NCS) bis 1.5 m:  
59.90 CHF (>1.5 m auf Anfrage)

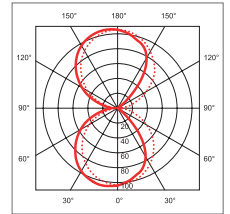
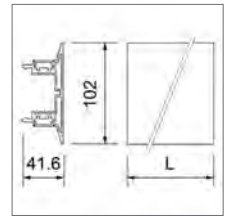

Variante	Länge	Leistung	Lichtstrom	Art.-Nr.	CHF
PUSH DIM	600 mm	24 W	2 x 670 lm	161-054-70	• 429.00
PUSH DIM	900 mm	36 W	2 x 1000 lm	161-055-70	• 499.00
PUSH DIM	1200 mm	47 W	2 x 1335 lm	161-056-70	• 549.00

Optional für 1200 mm	Art.-Nr.	CHF
<b>NEW</b> Notlichtelement, vollautomatischer Selbsttest, 3 h	UD-211-002-200	• 299.00



# Pendelleuchten

Es können neben reinen Pendelleuchten auch viele andere Produkte aus unserem Sortiment abgependelt werden. Hier ein Überblick.





Elegante Lichtlinien die im Raum zu schweben scheinen sind nicht nur ästhetisch sondern auch funktional. Durch Eckverbinder, Verbind- und variablen Seillängen bieten sie Möglichkeiten den Raum zu gestalten und bringen das Licht dorthin wo es gebraucht wird.



**Delight II LED**  
S. 229



**Cilindro LED**  
S. 215



**Line LED**  
S. 301



**Exit LED**  
S. 307



**Flat LED**  
S. 217



**Proof LED**  
S. 303

**Büro und Industrie:**

Neben klassischen Büroleuchten wie Flat LED oder Delight II LED können auch Leuchten für Garagen, Parkhäuser oder Werkstätte abgependelt werden.

Die gezeigte Darstellung dient als Inspiration und wurde graphisch optimiert. Das tatsächliche Produkt kann abweichen.



**Storage LED**  
S. 305





# Modern II LED | Pendelleuchte

Style am Seil



### Informationen

- Deko-Rand in 5 Farben erhältlich, passend für jedes Interior
- formschönes und modernes Design
- Leuchte und Baldachin aus Aluminium
- Treiber integriert

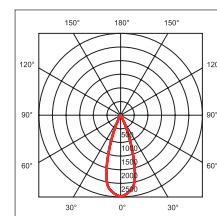
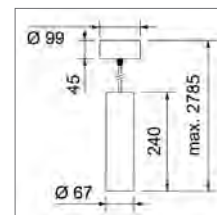

15 W
1300 lm
3000 K
CRI 90
Abstrahlwinkel: 36°
50'000h L80
350 mA

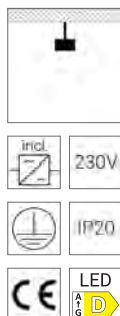

Variante	Farbe/Finish	Deko-Rand	Art.-Nr.	CHF
RC	weiss, strukturiert, ~RAL 9016	weiss	160-070-70	224.00
RC	weiss, strukturiert, ~RAL 9016	schwarz	160-071-70	224.00
RC	weiss, strukturiert, ~RAL 9016	chrom	160-072-70	224.00
RC	weiss, strukturiert, ~RAL 9016	gold	160-073-70	224.00
RC	weiss, strukturiert, ~RAL 9016	champagner	160-074-70	224.00
RC	schwarz, strukturiert, ~RAL 9004	weiss	160-075-70	224.00
RC	schwarz, strukturiert, ~RAL 9004	schwarz	160-076-70	224.00
RC	schwarz, strukturiert, ~RAL 9004	chrom	160-077-70	224.00
RC	schwarz, strukturiert, ~RAL 9004	gold	160-078-70	224.00
RC	schwarz, strukturiert, ~RAL 9004	champagner	160-079-70	224.00
<b>NEW</b> DALI 2	weiss, strukturiert, ~RAL 9016	weiss	160-080-70	279.00
<b>NEW</b> DALI 2	weiss, strukturiert, ~RAL 9016	schwarz	160-081-70	279.00
<b>NEW</b> DALI 2	weiss, strukturiert, ~RAL 9016	chrom	160-082-70	279.00
<b>NEW</b> DALI 2	weiss, strukturiert, ~RAL 9016	gold	160-083-70	279.00
<b>NEW</b> DALI 2	weiss, strukturiert, ~RAL 9016	champagner	160-084-70	279.00
<b>NEW</b> DALI 2	schwarz, strukturiert, ~RAL 9004	weiss	160-085-70	279.00
<b>NEW</b> DALI 2	schwarz, strukturiert, ~RAL 9004	schwarz	160-086-70	279.00
<b>NEW</b> DALI 2	schwarz, strukturiert, ~RAL 9004	chrom	160-087-70	279.00
<b>NEW</b> DALI 2	schwarz, strukturiert, ~RAL 9004	gold	160-088-70	279.00
<b>NEW</b> DALI 2	schwarz, strukturiert, ~RAL 9004	champagner	160-089-70	279.00

Zubehör	Art.-Nr.	CHF
Reflektor, 16°	160-070-09	16.00



## Duplex | Pendelleuchte

minimalistisch indirekt/direkt

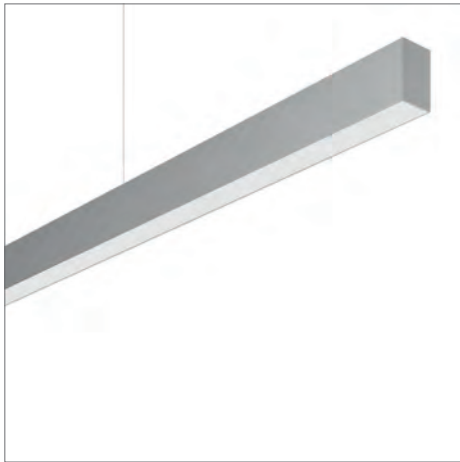

48 W  
3648 lm  
3000 K  
CRI 90  
Abstrahlwinkel: 120°  
50'000h L70

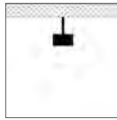

### Informationen

- mit Direkt-/Indirektlicht
- mit Touch-Dimmer, fertig montiert unter dem oberen Diffusor
- Ein/Ausschalten nur durch Touch-Dimmer
- einfache Montage mit Baldachin
- Länge Baldachin: 900 mm
- stufenloses Dimmen
- DC tauglich
- Finish: eloxiert
- andere Längen auf Anfrage
- Aufpreis Farben (RAL/NCS) bis 2 m: 139.00 CHF (>2 m auf Anfrage)

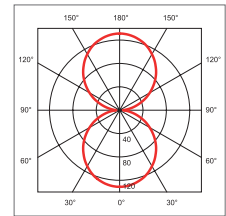
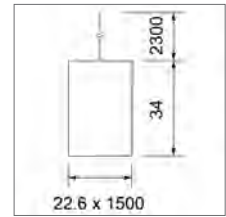

### Variante



Art.-Nr. CHF

161-045-70 • 689.00

## Modul 8 Flat | Pendelleuchte

klare und schöne Linie



29.5 / 36 W  
2855 / 3386 lm  
3000 K  
CRI 90  
Abstrahlwinkel: 160°  
60'000h L80

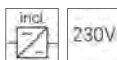
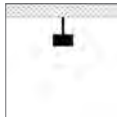

### Informationen

- homogenes Licht
- einfache Montage
- Treiber integriert
- 2 Leistungsstufen mit DIP Switch einstellbar - bis 1200 mA
- DC tauglich
- Farbe: weiss, ~RAL 9003
- Finish: pulverbeschichtet
- andere Längen auf Anfrage
- Aufpreis Farben (RAL/NCS) bis 2 m: 139.00 CHF (>2 m auf Anfrage)
- 4000 K auf Anfrage

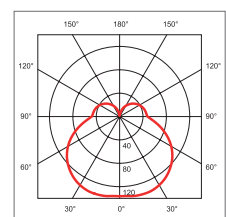
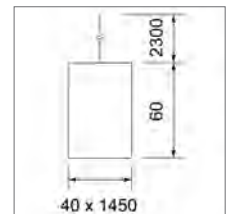

### Variante



Art.-Nr. CHF

161-047-70 • 639.00

### Optional

NEW



Notlichtelement, vollautomatischer Selbsttest, 3 h

Art.-Nr. CHF

UD-211-002-200 • 299.00

## Modular 60 Square | Pendelleuchte

markant alles integriert



### Informationen

- hochwertige quadratische Pendelleuchte
- Treiber integriert
- DC tauglich
- einfache Montage mit 4 Seilen
- Finish: eloxiert
- Aufpreis Farben (RAL/NCS) auf Anfrage

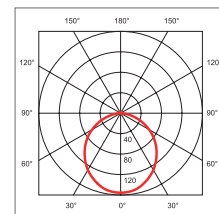
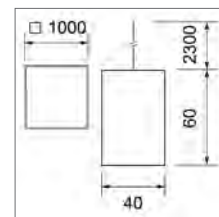

97 W  
4681 lm  
3000 K  
CRI 90  
Abstrahlwinkel: 120°  
50'000h L70

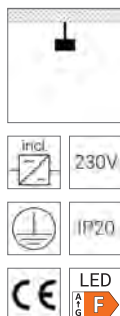

Variante	Art.-Nr.	CHF
	161-046-70	auf Anfrage

Optional	Art.-Nr.	CHF
<b>NEW</b> Notlichtelement, vollautomatischer Selbsttest, 3 h	UD-211-002-200	• 299.00

## Tube 35 | Pendelleuchte

schlanke Eleganz



### Informationen

- schöne und eigenständige Form
- einfache Montage mit Baldachin
- Länge Baldachin: 900 mm
- Stromführung im Seil integriert
- 200° Lichtaustritt
- Finish: eloxiert
- DC tauglich
- Aufpreis Farben (RAL/NCS) bis 2 m: 29.90 CHF (>2 m auf Anfrage)

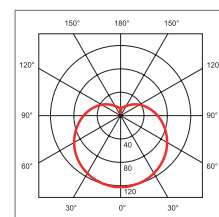
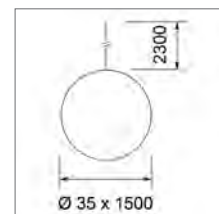

29 W  
2150 lm  
3000 K  
CRI 90  
Abstrahlwinkel: 200°  
50'000h L70

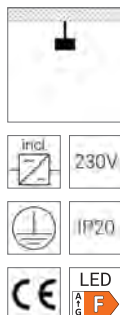

Variante	Art.-Nr.	CHF
	161-044-70	• 689.00



**Baldachin mit LED-Treiber**

inkl. Seilabhängung (2300 mm)

**Informationen**

- einfache Montage
- Stromführung im Seil integriert
- Kabeleinlass in der Mitte, Ø 8 mm
- DALI 2 / PushDim
- 1-10V auf Anfrage
- Finish: eloxiert
- andere Längen auf Anfrage
- Aufpreis Farben (RAL/NCS) bis 2 m: 49,90 CHF (>2 m auf Anfrage)

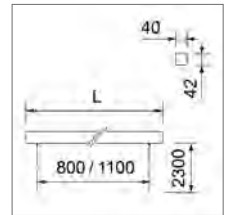

75 W, 140 W

30'000h

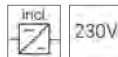

Variante	Länge	Leistung	Art.-Nr.	CHF
2	900 mm	75 W	161-101-10	394.90
2	1200 mm	140 W	161-101-11	427.00





**Float LED | Stehleuchte**

Elegant für den Büroalltag



78 W  
8400 lm  
4000 K  
CRI 80  
50'000h L70

**Informationen**

- moderne und effiziente Stehleuchte
- indirekt 75 %, direkt 25 %
- angenehmes Licht durch mikroprismatischer Diffusor
- Helligkeitssensor: immer das richtige Licht durch Konstantlichtregelung
- Präsenzsensor: Strom sparen
- Farbe: weiss, ~RAL 9016
- Finish: strukturiert

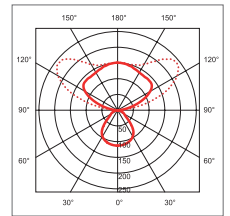
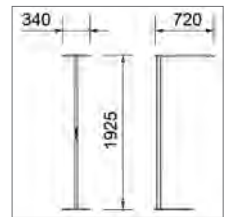
**Variante****Art.-Nr.**

160-090-40

**CHF**

949.00





## Asimo LED | Stehleuchte

Asymmetrie für einen gleichmässig ausgeleuchteten Tisch



### Informationen

- moderne und effiziente Stehleuchte
- indirekt 70 %, direkt 30 %
- angenehmes Licht durch mikroprismatischer Diffusor
- der asymmetrische Lichtaustritt lenkt das Licht genau auf die Arbeitsfläche
- Helligkeitssensor: immer das richtige Licht durch Konstantlichtregelung
- Strom sparen durch Präsenzsensoren
- Farbe: weiss, ~RAL 9016

passend zu  
Wandaufbauleuchte Asimo LED, S. 263

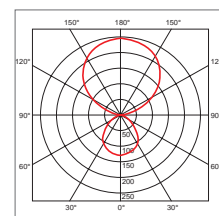
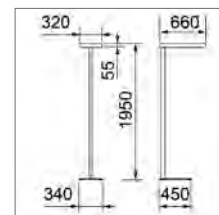

- 91 W
- 10100 lm
- 4000 K
- CRI 80
- 50'000h L70
- 600 mA

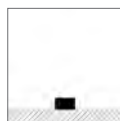

### Variante



### Art.-Nr.

160-009-41

### CHF

1489.00



# Unex One Stromschiene – Die Schlanke

Die Unex One ist die neue 1-Phasen Stromschiene. Egal ob in Wohnzimmer, Boutique oder Eingangshalle – sie gefällt. Sie besticht durch klare Linien und dezenten Auftritt.

## Erhältliche Farben



weiss, ~ RAL9003



schwarz, ~ RAL9005



**Unex  
One**

Alle passenden Leuchten sind mit diesem Piktogramm gekennzeichnet.



**RISIP Mini GU10 One**  
S. 288



**RISIP 12 W One**  
S. 290

# Unex Stromschiene – Eine für alles

Ob 3-Phasen- oder DALI-Stromschienen-Strahler: eine Schiene genügt. Einfacher geht es nicht. Selbst Ihre Lagerhaltung wird durch die geringere Typenvielfalt einfacher.

Ein Vorteil der Unex Stromschiene, den Sie nicht mehr missen möchten: Kein Biegen der Leiterkontakte mehr nach Zuschnitt der Stromschiene.

### Erhältliche Farben

weiss, ~ RAL9010     schwarz, ~ RAL9011

Kompatibilität	3-Phasen	DALI
GLOBAL Pro	■	
Lytespan 3	■	
EUTRAC	■	
Neuco	■	
Ivela	■	
Staff	■	
Norlux	■	
GLOBAL Trac Pulse		■



Alle passenden Leuchten sind mit diesem Piktogramm gekennzeichnet.



**RISP Mini GU10**  
3-Phasen  
S. 289



**RISP GU10**  
S. 289



**RISP 12 W**  
3-Phasen  
S. 291



**RISP 19 W**  
S. 291



**RISP 33 W**  
S. 292



**RISP 43 W**  
S. 295



**Modul 8**  
S. 296



**Modern II LED**  
S. 297

## Unex One | Stromschienen-System

1-Phasen Stromschiene, Aufbau/Pendel

Unex  
One **NEW**

### Aufbaustromschiene

kompatibel mit «One» Ausführungen der unex Stromschienen-Strahler

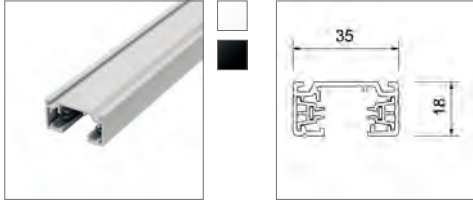

Länge	Farbe	Art.-Nr.	CHF
1000 mm	weiss, ~RAL 9003	141-103-100	26.90
2000 mm	weiss, ~RAL 9003	141-103-200	49.90
3000 mm	weiss, ~RAL 9003	141-103-300	72.90
1000 mm	schwarz, ~RAL 9005	141-104-100	26.90
2000 mm	schwarz, ~RAL 9005	141-104-200	49.90
3000 mm	schwarz, ~RAL 9005	141-104-300	72.90

Optional	Art.-Nr.	CHF
Stromschienen-Zuschnitt, Toleranz +/- 3 mm	Z-STROM-ZUS	9.90

### Endkappe

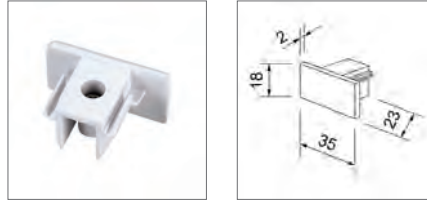

Variante	Art.-Nr.	CHF
weiss	141-107-000	1.90
schwarz	141-107-001	1.90

### Einschubanschlussstück

Erdung rechts

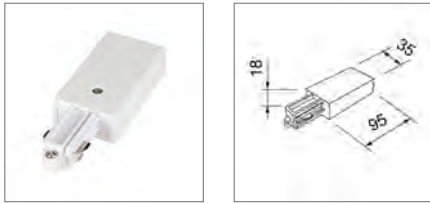

Variante	Art.-Nr.	CHF
weiss	141-105-000	8.90
schwarz	141-105-001	8.90

### Einschubanschlussstück

Erdung links

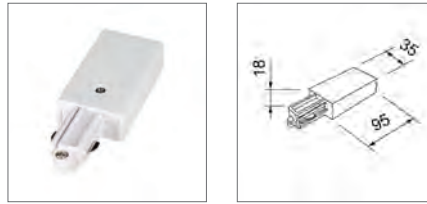

Variante	Art.-Nr.	CHF
weiss	141-106-000	8.90
schwarz	141-106-001	8.90

### Verbinder innenliegend

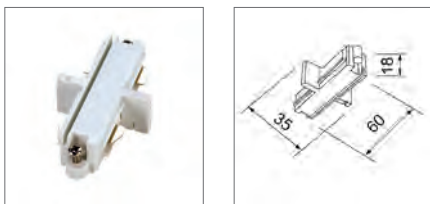

Variante	Art.-Nr.	CHF
weiss	141-111-000	7.60
schwarz	141-111-001	7.60

### Mittelverbinder

Einspeisung möglich

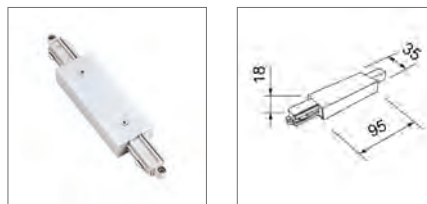

Variante	Art.-Nr.	CHF
weiss	141-108-000	19.90
schwarz	141-108-001	19.90

**L-Verbinder**

Erdung innen, Einspeisung möglich



Variante	Art.-Nr.	CHF
weiss	141-109-000	19.90
schwarz	141-109-001	19.90

**L-Verbinder**

Erdung aussen, Einspeisung möglich

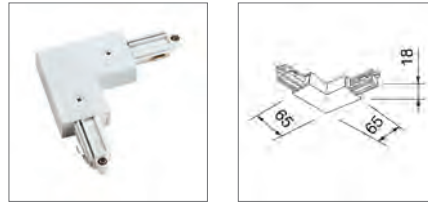

Variante	Art.-Nr.	CHF
weiss	141-110-000	19.90
schwarz	141-110-001	19.90

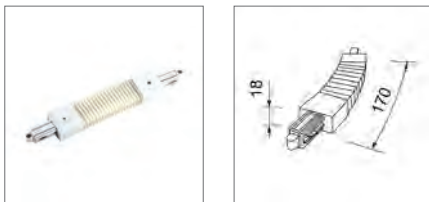
**Flexibler Verbinder**

Variante	Art.-Nr.	CHF
weiss	141-112-000	22.90
schwarz	141-112-001	22.90

**Seilabhängung**

mit 5 m Stahlseil

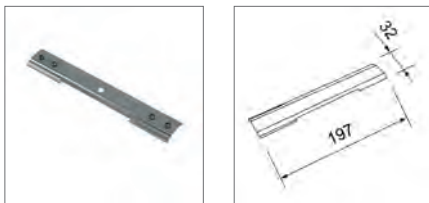

Variante	Art.-Nr.	CHF
	141-119-000	22.90

**Verbindungsabhängung**

Variante	Art.-Nr.	CHF
	141-120-000	7.90

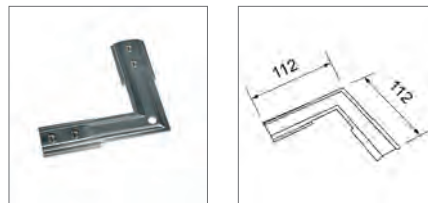
**L-Verbindungsabhängung**

Variante	Art.-Nr.	CHF
	141-121-000	8.90

**Abdeckstreifen**

Staub- und Berührungsschutz, Polycarbonat, 2000 mm

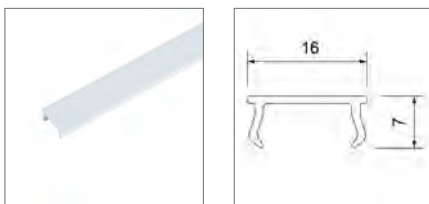

Variante	Art.-Nr.	CHF
weiss	141-129-200	5.90
schwarz	141-130-200	5.90

**Pendelleuchtenadapter**

Haken demontierbar

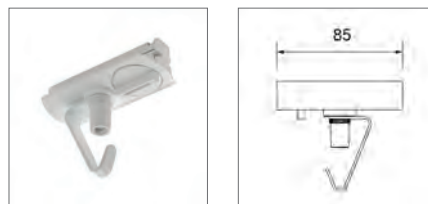

Variante	Art.-Nr.	CHF
weiss	141-127-000	14.90
schwarz	141-127-001	14.90



# Unex | Stromschienen-System

3-Phasen und DALI in einem schnell montiert

Unex  
3~

## Einbaustromschiene

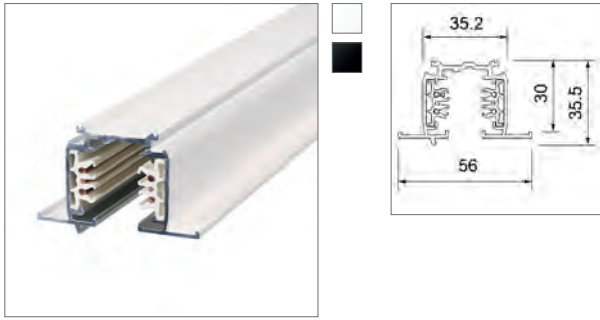

## Aufbaustromschiene

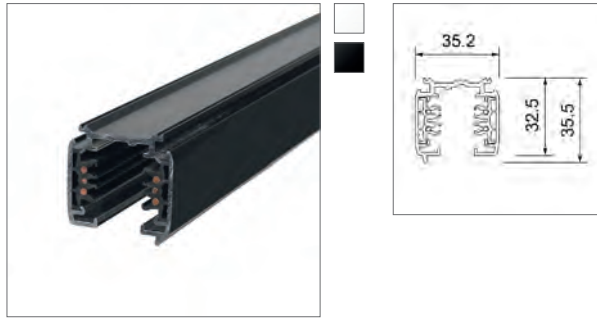

Länge	Farbe	Art.-Nr.	CHF
1000 mm	weiss, ~RAL 9010	141-001-100	39.00
2000 mm	weiss, ~RAL 9010	141-001-200	78.00
3000 mm	weiss, ~RAL 9010	141-001-300	114.00
4000 mm	weiss, ~RAL 9010	141-001-400	149.00
1000 mm	schwarz, ~RAL 9011	141-002-101	39.00
2000 mm	schwarz, ~RAL 9011	141-002-201	78.00
3000 mm	schwarz, ~RAL 9011	141-002-301	114.00
4000 mm	schwarz, ~RAL 9011	141-002-401	149.00

Länge	Farbe	Art.-Nr.	CHF
1000 mm	weiss, ~RAL 9010	141-003-100	31.00
2000 mm	weiss, ~RAL 9010	141-003-200	62.00
3000 mm	weiss, ~RAL 9010	141-003-300	92.00
4000 mm	weiss, ~RAL 9010	141-003-400	122.00
1000 mm	schwarz, ~RAL 9011	141-004-101	31.00
2000 mm	schwarz, ~RAL 9011	141-004-201	62.00
3000 mm	schwarz, ~RAL 9011	141-004-301	92.00
4000 mm	schwarz, ~RAL 9011	141-004-401	122.00

Optional	Art.-Nr.	CHF
Stromschienen-Zuschnitt, Toleranz +/- 3 mm	Z-STROM-ZUS	9.90

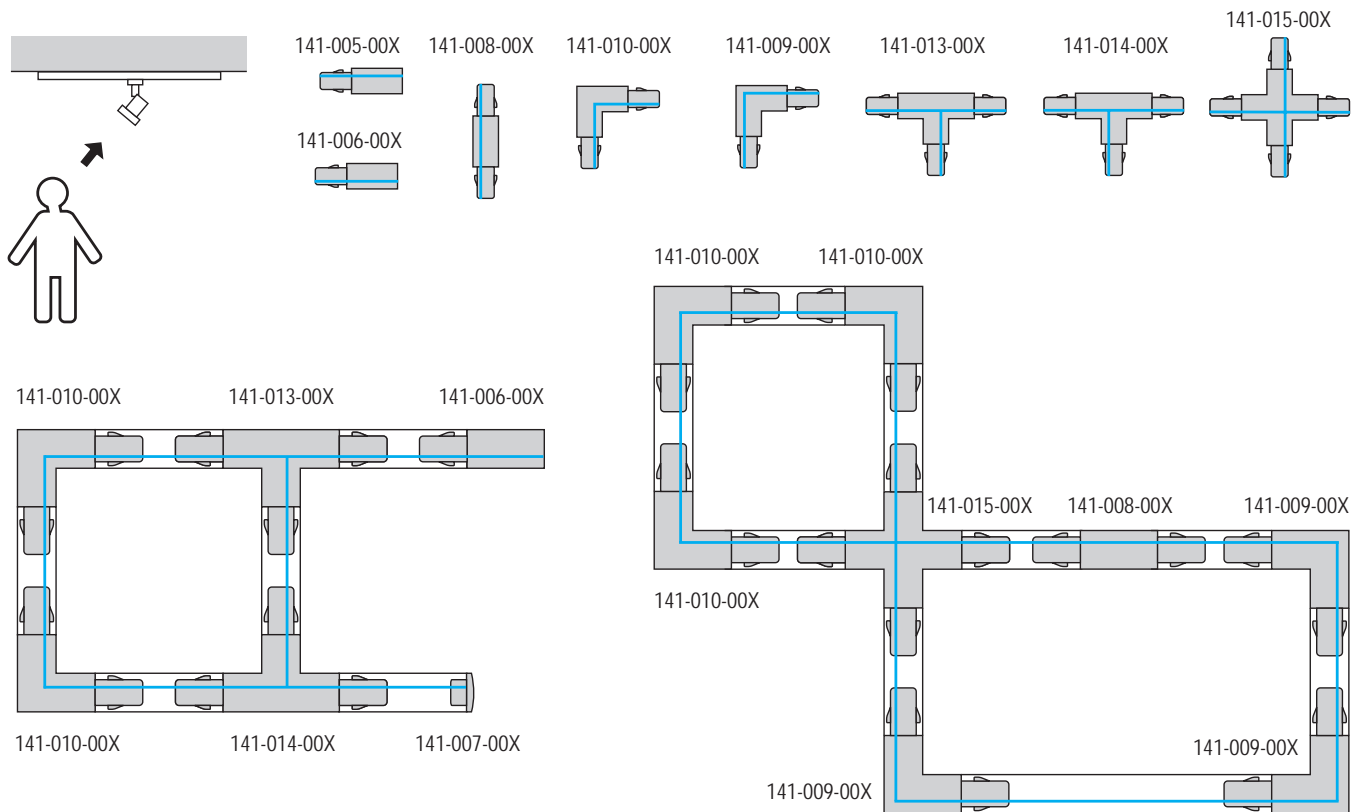

— = Neutralleiter

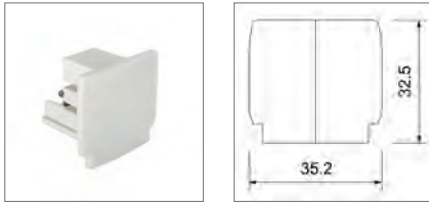
**Endkappe**

Variante	Art.-Nr.	CHF
weiss, ~RAL 9010	141-007-000	2.00
schwarz, ~RAL 9011	141-007-001	2.00

**Einschubanschlusstück**

3-Phasen und DALI, Erdung rechts

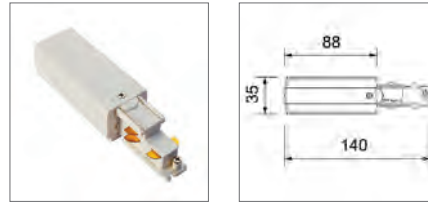

Variante	Art.-Nr.	CHF
weiss, ~RAL 9010	141-005-000	11.50
schwarz, ~RAL 9011	141-005-001	11.50

**Einschubanschlusstück**

3-Phasen und DALI, Erdung links

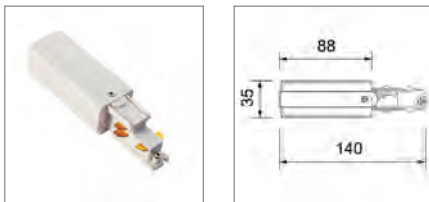

Variante	Art.-Nr.	CHF
weiss, ~RAL 9010	141-006-000	11.50
schwarz, ~RAL 9011	141-006-001	11.50

**Verbinder innenliegend**

3-Phasen und DALI

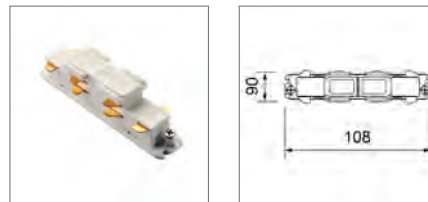

Variante	Art.-Nr.	CHF
weiss, ~RAL 9010	141-011-000	8.40
schwarz, ~RAL 9011	141-011-001	8.40

**Mittelverbinder**

3-Phasen und DALI, Einspeisung möglich

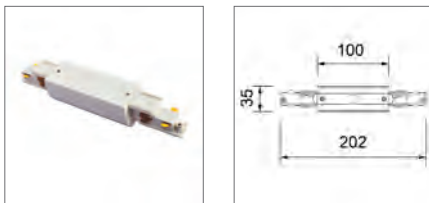

Variante	Art.-Nr.	CHF
weiss, ~RAL 9010	141-008-000	37.00
schwarz, ~RAL 9011	141-008-001	37.00

**L-Verbinder**

3-Phasen und DALI, Erdung innen

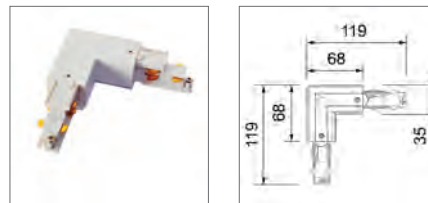

Variante	Art.-Nr.	CHF
weiss, ~RAL 9010	141-009-000	26.90
schwarz, ~RAL 9011	141-009-001	26.90

**L-Verbinder**

3-Phasen und DALI, Erdung aussen

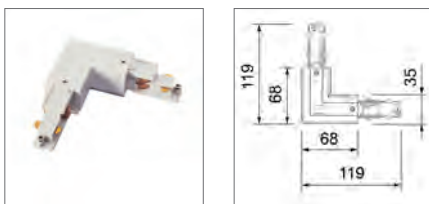

Variante	Art.-Nr.	CHF
weiss, ~RAL 9010	141-010-000	26.90
schwarz, ~RAL 9011	141-010-001	26.90

**Flexibler Verbinder**

3-Phasen und DALI

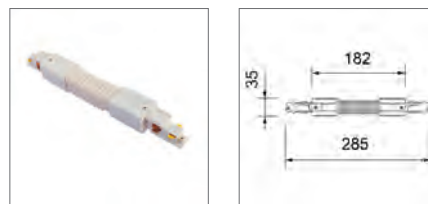

Variante	Art.-Nr.	CHF
weiss, ~RAL 9010	141-012-000	37.00
schwarz, ~RAL 9011	141-012-001	37.00

**X-Verbinder**

3-Phasen und DALI

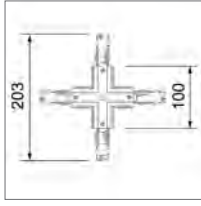

Variante	Art.-Nr.	CHF
weiss, ~RAL 9010	141-015-000	49.00
schwarz, ~RAL 9011	141-015-001	49.00

**T-Verbinder**

3-Phasen und DALI, Erdung rechts

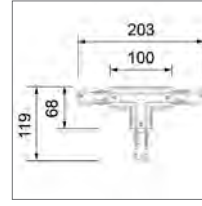

Variante	Art.-Nr.	CHF
weiss, ~RAL 9010	141-013-000	33.00
schwarz, ~RAL 9011	141-013-001	33.00

**T-Verbinder**

3-Phasen und DALI, Erdung rechts, Abzweigung Erdung links

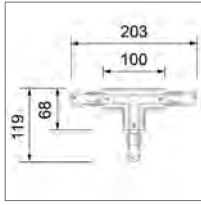

Variante	Art.-Nr.	CHF
weiss, ~RAL 9010	141-014-000	33.00
schwarz, ~RAL 9011	141-014-001	33.00

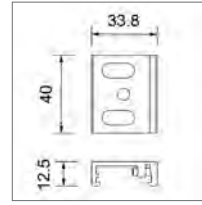
**Befestigungsklammer**

Variante	Art.-Nr.	CHF
weiss, ~RAL 9010	141-017-000	2.40
schwarz, ~RAL 9011	141-017-001	2.40

**Stangenabhängung**

mit 1 m Gewindestange

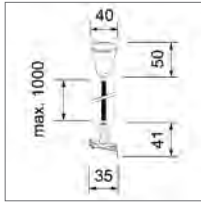

Variante	Art.-Nr.	CHF
weiss, ~RAL 9010	141-018-000	16.00
schwarz, ~RAL 9011	141-018-001	16.00

**Seilabhängung**

mit 5 m Stahlseil

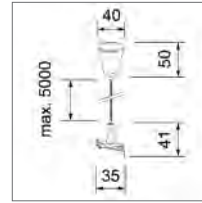

Variante	Art.-Nr.	CHF
weiss, ~RAL 9010	141-019-000	11.90
schwarz, ~RAL 9011	141-019-001	11.90

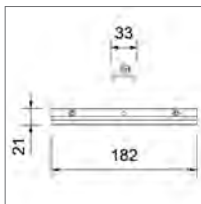
**Verbindungsabhängung**

Variante	Art.-Nr.	CHF
weiss, ~RAL 9010	141-020-000	7.30
schwarz, ~RAL 9011	141-020-001	7.30

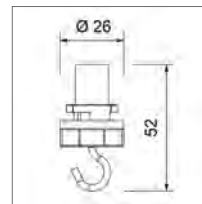
**Displayhaken**

Variante	Art.-Nr.	CHF
weiss, ~RAL 9010	141-021-000	2.50
schwarz, ~RAL 9011	141-021-001	2.50

**DALI-Adapter**

3-Phasen und DALI

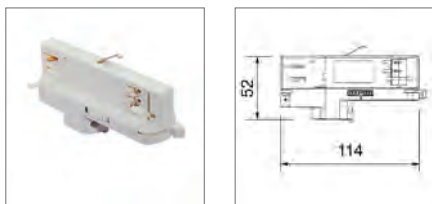

Variante	Art.-Nr.	CHF
weiss, ~RAL 9010	141-027-000	18.00
schwarz, ~RAL 9011	141-027-001	18.00

**Abdeckplatte**

für Einschubanschlussstück

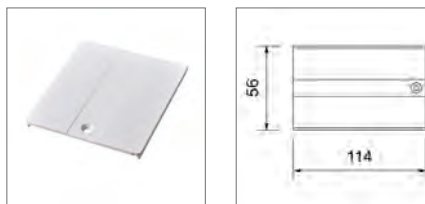

Variante	Art.-Nr.	CHF
weiss, ~RAL 9010	141-022-000	6.20
schwarz, ~RAL 9011	141-022-001	6.20

**Abdeckplatte**

für Mittelverbinder

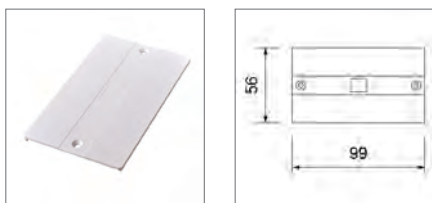

Variante	Art.-Nr.	CHF
weiss, ~RAL 9010	141-023-000	6.20
schwarz, ~RAL 9011	141-023-001	6.20

**Abdeckplatte**

für L-Verbinder

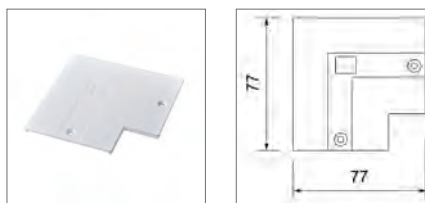

Variante	Art.-Nr.	CHF
weiss, ~RAL 9010	141-024-000	6.20
schwarz, ~RAL 9011	141-024-001	6.20

**Abdeckplatte**

für T-Verbinder

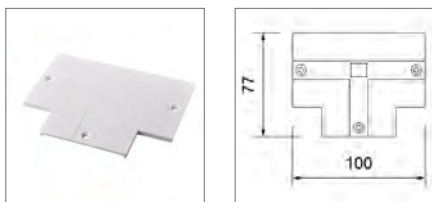

Variante	Art.-Nr.	CHF
weiss, ~RAL 9010	141-025-000	6.20
schwarz, ~RAL 9011	141-025-001	6.20

**Abdeckplatte**

für X-Verbinder

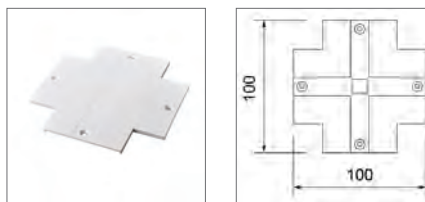

Variante	Art.-Nr.	CHF
weiss, ~RAL 9010	141-026-000	6.20
schwarz, ~RAL 9011	141-026-001	6.20

**Abdeckstreifen**

Staub- und Berührungsschutz, Polycarbonat



Variante	Art.-Nr.	CHF
1000 mm, weiss, ~RAL 9010	141-029-100	2.70
2000 mm, weiss, ~RAL 9010	141-029-200	4.90
3000 mm, weiss, ~RAL 9010	141-029-300	6.90
1000 mm, schwarz, ~RAL 9011	141-029-101	2.70
2000 mm, schwarz, ~RAL 9011	141-029-201	4.90
3000 mm, schwarz, ~RAL 9011	141-029-301	6.90

**Monopoint**

3-Phasen und DALI

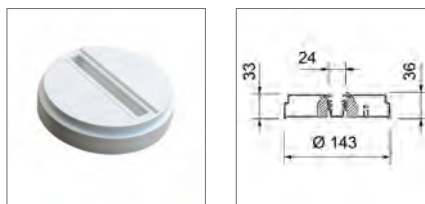

Variante	Art.-Nr.	CHF
weiss, ~RAL 9010	141-028-000	44.00
schwarz, ~RAL 9011	141-028-001	44.00



**RISP Mini GU10 One | Stromschienen-Strahler**

klein, wertig, praktisch

Unex  
One

NEW

**Informationen**

- ohne Leuchtmittel GU10
- max. 1 x 6 W (LED)
- Unex One Adapter (1-Phasen)
- 90° schwenkbar
- 350° drehbar
- Leuchte aus Aluminium
- Finish: strukturiert

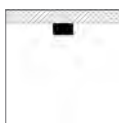
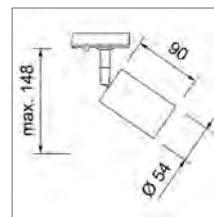

Farben	Art.-Nr.	CHF
weiss, ~RAL 9003	140-030-50	74.00
schwarz, ~RAL 9005	140-031-50	74.00

Leuchtmittlempfehlung	Lichtsteuerung	Seite
Unex Lamp GU10	RC	196

**RISP Mini GU10 1-Phasen | Stromschienen-Strahler**

klein, wertig, praktisch

**Informationen**

- ohne Leuchtmittel GU10
- max. 1 x 6 W (LED)
- Global Track Adapter GB66 (1-Phasen)
- 90° schwenkbar
- 350° drehbar
- Leuchte aus Aluminium
- Finish: strukturiert

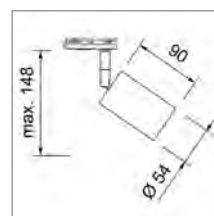

Farben	Art.-Nr.	CHF
weiss, ~RAL 9003	140-026-50	84.00
schwarz, ~RAL 9005	140-028-50	84.00

Leuchtmittlempfehlung	Lichtsteuerung	Seite
Unex Lamp GU10	RC	196

**RISP Mini GU10 3-Phasen | Stromschienen-Strahler**

klein, wertig, praktisch

Unex  
3~**Informationen**

- ohne Leuchtmittel GU10
- max. 1 x 6 W (LED)
- Global Track Adapter GA69 (3-Phasen)
- 90° schwenkbar
- 350° drehbar
- Leuchte aus Aluminium
- Finish: strukturiert

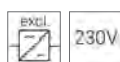
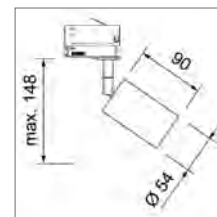

Farbe	Art.-Nr.	CHF
weiss, ~RAL 9003	140-027-50	84.00
schwarz, ~RAL 9005	140-029-50	84.00

Leuchtmittelempfehlung	Lichtsteuerung	Seite
Unex Lamp GU10		196

**RISP GU10 | Stromschienen-Strahler**

Strahler für RIDL 7 und GU10 Leuchtmittel

Unex  
3~**Informationen**

- ohne Leuchtmittel GU10
- max. 10 W (LED)
- Global Track-Adapter GA69 (3-Phasen)
- 95° schwenkbar
- 320° drehbar
- Leuchte aus Aluminium
- Finish: matt

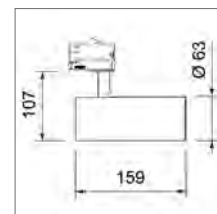

Farbe	Art.-Nr.	CHF
weiss, ~RAL 9016	140-004-51	99.00
schwarz, ~RAL 9004	140-014-51	99.00

Leuchtmittelempfehlung	Lichtsteuerung	Seite
RIDL 7 GU10		189
Unex Lamp GU10		196

Zubehör	Art.-Nr.	CHF
Frontring, schwarz, ~RAL 9004	140-040-90	8.50

**RISP 12 W One | Stromschienen-Strahler**

wunderschöne Lichtverteilung

Unex  
OneCRI  
90

NEW

**Informationen**

- Unex One Adapter (1-Phasen)
- 90° schwenkbar
- 350° drehbar
- Leuchte aus Aluminium
- Finish: strukturiert

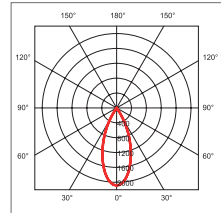
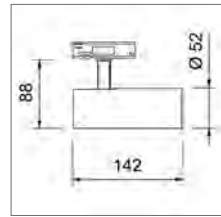

14 W
1070 lm, 1100 lm
2700 K, 3000 K
CRI 90
Abstrahlwinkel: 36°
50'000h L70
350 mA

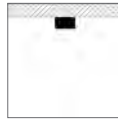

Variante	Farbe	Farbtemp.	Lichtstrom	Art.-Nr.	CHF
↙	weiss, ~RAL 9016	2700 K	1070 lm	140-036-20	139.00
↘	weiss, ~RAL 9016	3000 K	1100 lm	140-036-70	139.00
↙	schwarz, ~RAL 9004	2700 K	1070 lm	140-037-20	139.00
↘	schwarz, ~RAL 9004	3000 K	1100 lm	140-037-70	139.00

Zubehör	Art.-Nr.	CHF
Reflektor, 20°	130-890-96	16.00
Reflektor, 60°	130-890-99	16.00
Frontring, schwarz, ~RAL 9004	140-016-90	8.50

**RISP 12 W 1-Phasen | Stromschienen-Strahler**

wunderschöne Lichtverteilung

CRI  
90**Informationen**

- Global Track Adapter GB66 (1-Phasen)
- Leuchte aus Aluminium
- 95° schwenkbar
- 350° drehbar
- Finish: strukturiert

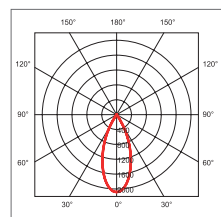
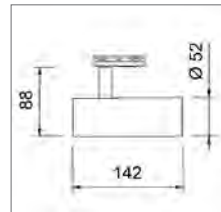

14 W
1070 lm, 1100 lm
2700 K, 3000 K
CRI 90
Abstrahlwinkel: 36°
50'000h L70
350 mA

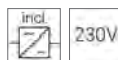

Variante	Farbe	Farbtemp.	Lichtstrom	Art.-Nr.	CHF
↙	weiss, ~RAL 9016	2700 K	1070 lm	140-015-21	149.00
↘	weiss, ~RAL 9016	3000 K	1100 lm	140-015-71	149.00
↙	schwarz, ~RAL 9004	2700 K	1070 lm	140-022-21	149.00
↘	schwarz, ~RAL 9004	3000 K	1100 lm	140-022-71	149.00

Zubehör	Art.-Nr.	CHF
Reflektor, 20°	130-890-96	16.00
Reflektor, 60°	130-890-99	16.00
Frontring, schwarz, ~RAL 9004	140-016-90	8.50

**RISP 12 W 3-Phasen | Stromschienen-Strahler**

wunderschöne Lichtverteilung

Unex  
3~CRI  
90**Informationen**

- Global Track Adapter GA69 (3-Phasen)
- Leuchte aus Aluminium
- 95° schwenkbar
- 350° drehbar
- Finish: strukturiert

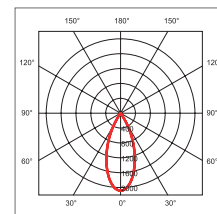
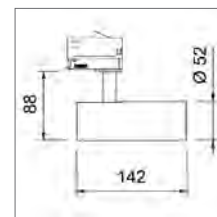

14 W

1070 lm, 1100 lm

2700 K, 3000 K

CRI 90

Abstrahlwinkel: 36°

50'000h L70

350 mA



Variante	Farbe	Farbtemp.	Lichtstrom	EEK	Art.-Nr.	CHF
▲ R.C	weiss, ~RAL 9016	2700 K	1070 lm	F	140-016-21	149.00
▲ R.C	weiss, ~RAL 9016	3000 K	1100 lm	F	140-016-71	149.00
▲ R.C	weiss, ~RAL 9016	4000 K	1200 lm	E	140-016-41	149.00
▲ R.C	schwarz, ~RAL 9004	2700 K	1070 lm	F	140-023-21	149.00
▲ R.C	schwarz, ~RAL 9004	3000 K	1100 lm	F	140-023-71	149.00
▲ R.C	schwarz, ~RAL 9004	4000 K	1200 lm	E	140-023-41	149.00

Zubehör	Art.-Nr.	CHF
Reflektor, 20°	130-890-96	16.00
Reflektor, 60°	130-890-99	16.00
Frontring, schwarz, ~RAL 9004	140-016-90	8.50

**RISP 19 W | Stromschienen-Strahler**

wunderschöne Lichtverteilung

Unex  
3~CRI  
90

NEW

**Informationen**

- Global Track Adapter GA69 (3-Phasen)
- Leuchte aus Aluminium
- 95° schwenkbar
- 350° drehbar
- Finish: strukturiert

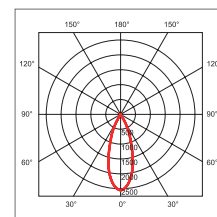
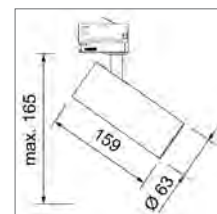

19 W

1450 lm, 1500 lm

2700 K, 3000 K

CRI 90

Abstrahlwinkel: 40°

35'000h L70

500 mA

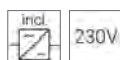

Variante	Farbe	Farbtemp.	Lichtstrom	Art.-Nr.	CHF
▲ R.C	weiss, ~RAL 9016	2700 K	1450 lm	140-040-21	199.00
▲ R.C	weiss, ~RAL 9016	3000 K	1500 lm	140-040-71	199.00
▲ R.C	schwarz, ~RAL 9004	2700 K	1450 lm	140-041-21	199.00
▲ R.C	schwarz, ~RAL 9004	3000 K	1500 lm	140-041-71	199.00

Zubehör	Art.-Nr.	CHF
Reflektor, 24°	140-041-99	19.00
Frontring, schwarz, ~RAL 9004	140-040-90	8.50



## RISP 33 W Phasenabschnitt | Strahlschienen-Strahler

Ihre Produkte im besten Licht

Unex  
3~

GAI  
100

CRI  
95

NEW



### Informationen

- CRI 95 / GAI 100 für beste Farbsättigung
- neueste LED-Chip Technologie
- Global Track Adapter GA69 (3-Phasen)
- 95° schwenkbar
- 350° drehbar
- Finish: strukturiert

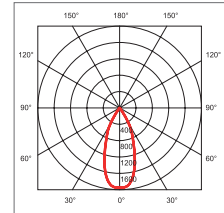
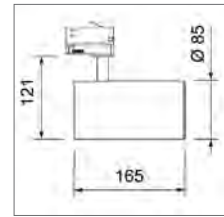

35 W

2800 lm, 2900 lm, 3100 lm

2700 K, 3000 K, 4000 K

CRI 95, GAI 100

Abstrahlwinkel: 40°

35'000h L70

900 mA



Variante	Farbe	Farbtemp.	Lichtstrom	EEK	Art.-Nr.	CHF
↙	weiss, ~RAL 9016	2700 K	2800 lm	F	140-017-22	299.00
↙	weiss, ~RAL 9016	3000 K	2900 lm	F	140-017-72	299.00
↙	weiss, ~RAL 9016	4000 K	3100 lm	E	140-017-42	299.00
↙	schwarz, ~RAL 9004	2700 K	2800 lm	F	140-018-22	299.00
↙	schwarz, ~RAL 9004	3000 K	2900 lm	F	140-018-72	299.00
↙	schwarz, ~RAL 9004	4000 K	3100 lm	E	140-018-42	299.00

Zubehör	Art.-Nr.	CHF
Wabenraster, Ø 75 mm, schwarz	130-340-90	12.90
Schutzglas, Ø 75 mm, klar	130-340-91	12.90
Reflektor, 24°	130-340-93	22.00
Reflektor, 60°	130-340-94	22.00
Frontring, schwarz, ~RAL 9004	140-017-90	9.50



**RISP 33 W DALI | Stromschienen-Strahler**

Ihre Produkte im besten Licht

**Informationen**

- CRI 95 / GAI 100 für beste Farbsättigung
- neueste LED-Chip Technologie
- Global Track Pulse Adapter GAC69 (3-Phasen und DALI)
- 95° schwenkbar
- 350° drehbar
- Finish: strukturiert

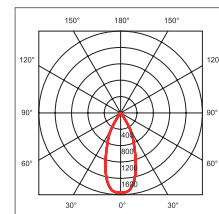
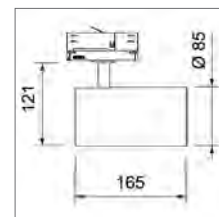

36 W

2800 lm, 2900 lm, 3100 lm

2700 K, 3000 K, 4000 K

CRI 95, GAI 100

Abstrahlwinkel: 40°

35'000h L70

900 mA

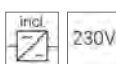
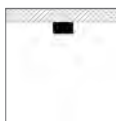

Variante Farbe	Farbtemp.	Lichtstrom	EEK	Art.-Nr.	CHF
weiss, ~RAL 9016	2700 K	2800 lm	F	140-012-22	349.00
weiss, ~RAL 9016	3000 K	2900 lm	F	140-012-72	349.00
weiss, ~RAL 9016	4000 K	3100 lm	E	140-012-42	349.00
schwarz, ~RAL 9004	2700 K	2800 lm	F	140-013-22	349.00
schwarz, ~RAL 9004	3000 K	2900 lm	F	140-013-72	349.00
schwarz, ~RAL 9004	4000 K	3100 lm	E	140-013-42	349.00

Zubehör	Art.-Nr	CHF
Wabenraster, Ø 75 mm, schwarz	130-340-90	12.90
Schutzglas, Ø 75 mm, klar	130-340-91	12.90
Reflektor, 24°	130-340-93	22.00
Reflektor, 60°	130-340-94	22.00
Frontring, schwarz, ~RAL 9004	140-017-90	9.50







**RISP 43 W 3000 K, CRI 95 | Stromschienen-Strahler**

Ihre Produkte im besten Licht

**Unex**  
3~ **GAI**  
100 **CRI**  
95**Informationen**

- CRI 95 / GAI 100 für beste Farbsättigung
- neueste LED-Chip Technologie
- Global Track Adapter GA69 (3-Phasen)
- 95° schwenkbar
- 350° drehbar
- Finish: strukturiert

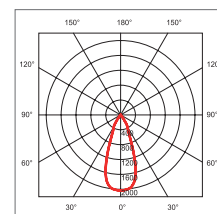
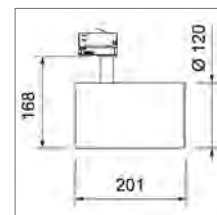

47 W

4000 lm

3000 K

CRI 95, GAI 100

Abstrahlwinkel: 40°

50'000h L80

1200 mA

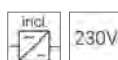
**Variante Farbe**

	Variante	Farbe	Art.-Nr.	CHF
⏻	weiss,	~RAL 9016	140-020-71	369.00
⏻	schwarz,	~RAL 9004	140-021-71	369.00

**Zubehör**

	Zubehör	Art.-Nr.	CHF
	Frontring, schwarz, ~RAL 9004	140-020-90	10.60

**RISP 43 W 4000 K, CRI 90 | Stromschienen-Strahler**

Ihre Produkte im besten Licht

**Unex**  
3~ **CRI**  
90**Informationen**

- neueste LED-Chip Technologie
- Global Track Adapter GA69 (3-Phasen)
- 95° schwenkbar
- 350° drehbar
- Finish: strukturiert

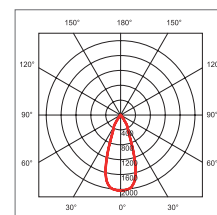
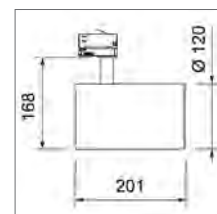

47 W

4700 lm

4000 K

CRI 90

Abstrahlwinkel: 40°

50'000h L80

1200 mA

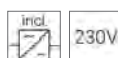
**Variante Farbe**

	Variante	Farbe	Art.-Nr.	CHF
⏻	weiss,	~RAL 9016	140-020-41	369.00
⏻	schwarz,	~RAL 9004	140-021-41	369.00

**Zubehör**

	Zubehör	Art.-Nr.	CHF
	Frontring, schwarz, ~RAL 9004	140-020-90	10.60



## Modul 8 | Stromschienen-Leuchte

Grundbeleuchtung nach Mass

Unex  
3~

CRI  
90



### Informationen

- klare und schöne Linie
- homogenes Licht
- mit DALI-/3-Phasen-Adapter für Unex Stromschiene

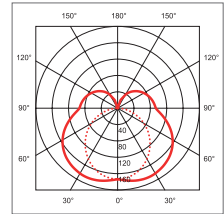
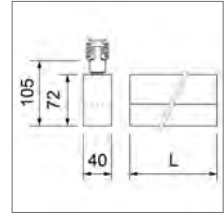

18 W, 27 W, 36 W, 45 W

1300 – 3400 lm

3000 K, 4000 K

CRI 90

Abstrahlwinkel: 160°

50'000h L70

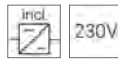

	Variante	Länge	Farbtemp.	Leistung	Lichtstrom	Art.-Nr.	CHF
	2	600 mm	3000 K	18 W	1300 lm	161-050-70	• 429.00
<b>NEW</b>	2	600 mm	4000 K	18 W	1400 lm	161-050-40	• 429.00
	2	900 mm	3000 K	27 W	1950 lm	161-051-70	• 479.00
<b>NEW</b>	2	900 mm	4000 K	27 W	2100 lm	161-051-40	• 479.00
	2	1200 mm	3000 K	36 W	2600 lm	161-052-70	• 534.00
<b>NEW</b>	2	1200 mm	4000 K	36 W	2700 lm	161-052-40	• 534.00
	2	1500 mm	3000 K	45 W	3250 lm	161-053-70	• 554.00
<b>NEW</b>	2	1500 mm	4000 K	45 W	3400 lm	161-053-40	• 554.00

## Modern II LED | Stromschienen-Leuchte

Style am Seil

Unex  
3~

CRI  
90

NEW



### Informationen

- Deko-Rand in 5 Farben erhältlich, passend für jedes Interior
- formschönes und modernes Design
- Leuchte aus Aluminium
- Global Track Pulse Adapter GAC69 (3-Phasen und DALI)
- Treiber integriert

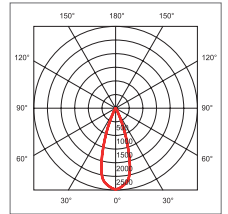
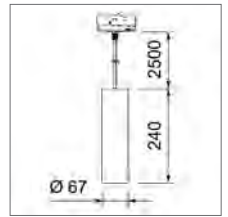

15 W

1300 lm

3000 K

CRI 90

Abstrahlwinkel: 36°

50'000h L80

350 mA

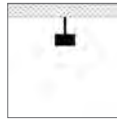

Variante	Farbe/Finish	Deko-Rand	Art.-Nr.	CHF
DALI 2	weiss, strukturiert, ~RAL 9016	weiss	140-070-70	309.00
DALI 2	weiss, strukturiert, ~RAL 9016	schwarz	140-071-70	309.00
DALI 2	weiss, strukturiert, ~RAL 9016	chrom	140-072-70	309.00
DALI 2	weiss, strukturiert, ~RAL 9016	gold	140-073-70	309.00
DALI 2	weiss, strukturiert, ~RAL 9016	champagner	140-074-70	309.00
DALI 2	schwarz, strukturiert, ~RAL 9004	weiss	140-075-70	309.00
DALI 2	schwarz, strukturiert, ~RAL 9004	schwarz	140-076-70	309.00
DALI 2	schwarz, strukturiert, ~RAL 9004	chrom	140-077-70	309.00
DALI 2	schwarz, strukturiert, ~RAL 9004	gold	140-078-70	309.00
DALI 2	schwarz, strukturiert, ~RAL 9004	champagner	140-079-70	309.00

### Zubehör

Reflektor, 16°

Art.-Nr.

CHF

160-070-09

16.00

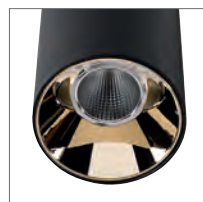
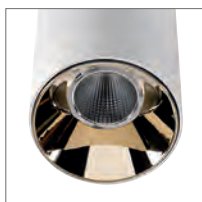
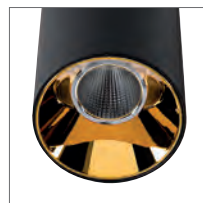
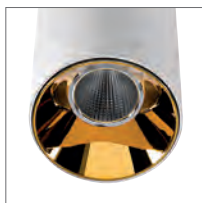
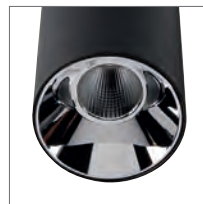
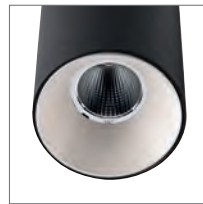



## Link LED | Balkenleuchte

die schlanke Variante

CRI 90



9 W, 13 W, 18 W

940 – 1960 lm

3000/4000 K switchable

CRI 90

Abstrahlwinkel: 130°

35'000h L70

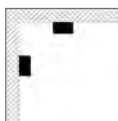

### Informationen

- Einspeisung stirnseitig
- einfach erweiterbar mit Verbindungsstück oder Verbindungskabel
- Ein/Aus Schalter
- von 3000 auf 4000 Kelvin umschaltbar
- DC tauglich
- universell einsetzbar
- Ersatz für Lichtleisten mit konventionellen Leuchtstoffröhren
- inkl. Befestigungsklammern, Abdeckkappe und Anschlusskabel (1,8 m / 2 x 0.75 mm<sup>2</sup>)
- max. 0.55 A / 98 W aneinandergereiht

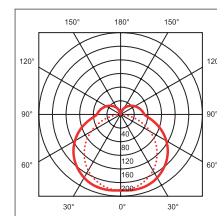
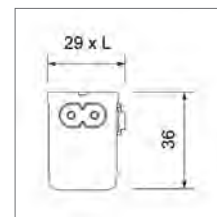

Variante	Länge	Leistung	3000 K	4000 K	Art.-Nr.	CHF
🔌	585 mm	9 W	940 lm	980 lm	160-051-70	49.00
🔌	885 mm	13 W	1400 lm	1450 lm	160-052-70	59.00
🔌	1185 mm	18 W	1900 lm	1960 lm	160-053-70	69.00



### Befestigungsklammer

Kunststoff

Variante	Art.-Nr.	CHF
	160-054-98	9.90



### Abdeckkappe

Kunststoff

Variante	Art.-Nr.	CHF
	160-054-97	1.00



### Verbindungskabel

230 V Spannung, ~50 Hz, 2 x 0.75 mm<sup>2</sup>

Länge	Art.-Nr.	CHF
260 mm	160-054-95	6.90



### Verbindungsstück

Kunststoff

Variante	Art.-Nr.	CHF
	160-054-96	6.90





## Line LED | Balkenleuchte

effizient und wertig in jeder Hinsicht



23 W, 24 W, 32 W, 34 W

3200 – 4800 lm

3000 K, 4000 K

CRI 80

Abstrahlwinkel: 120°

50'000h L80

700 mA

1200 mm:  $U_F$  26 – 29 V

1500 mm:  $U_F$  37 – 40 V

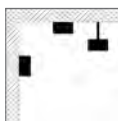

### Informationen

- hohe Lichtausbeute mit bis zu 150 lm/W
- einfache Montage
- für Durchgangsverdrahtung vorbereitet
- DC tauglich
- nur eine Option auswählbar
- Phasenabschnitt auf Anfrage (ohne HF-Sensor)
- Farbe: weiss, ~RAL 9016
- Not-Variante: vollautomatischer Selbsttest
- Not-Variante: 3h Brenndauer

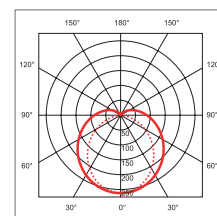
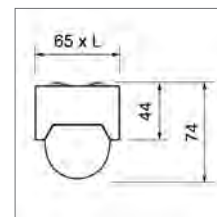

Variante	Länge	Leistung	Lichtstrom	Farbtemperatur	Art.-Nr.	CHF
	1200 mm	23 W	3200 lm	3000 K	185-003-71	139.00
	1200 mm	23 W	3400 lm	4000 K	185-003-41	139.00
	1500 mm	32 W	4500 lm	3000 K	185-005-71	159.00
	1500 mm	32 W	4800 lm	4000 K	185-005-41	159.00
	1200 mm	24 W	3200 lm	3000 K	185-004-71	319.00
	1200 mm	24 W	3400 lm	4000 K	185-004-41	319.00
	1500 mm	34 W	4500 lm	3000 K	185-006-71	339.00
	1500 mm	34 W	4800 lm	4000 K	185-006-41	339.00

Optional	Art.-Nr.	CHF
HF-Sensor	UD-043-101-00	• 109.00
Multi-Konstantstrom-Treiber, 45 W, 700 mA	UD-043-102-00	• 109.00

Zubehör	Art.-Nr.	CHF
Seilabhängung, 2000 mm, Ø 1.5 mm	100-004-003	16.00

Ersatzteil	Art.-Nr.	CHF
Akku-Pack, LiFePO4 3.2V 4.5Ah, ta max. 60°	211-001-000	54.00





## Proof LED | Feuchtraum-Wannenleuchte

fit für den Einsatz

NEW



40 W, 55 W  
4700 lm, 7100 lm  
4000 K  
CRI 80  
50'000h L70  
700 mA, 1050 mA

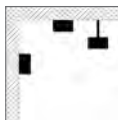

### Informationen

- komplett aus Polycarbonat
- Verschlüsse aus Edelstahl
- homogene Ausleuchtung
- für Aussenmontage Anleitung beachten
- Einspeisung stirnseitig oder von oben
- mit werkzeugloser 5-poliger Anschlussklemme
- mit interner Durchgangsverdrahtung 5 x 2,5 mm<sup>2</sup>
- inkl. Befestigungsklammer, Bügel für Kettenmontage und M20 Verschraubung
- Einsatztemperaturbereich -25 bis +40 °C

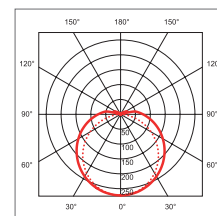
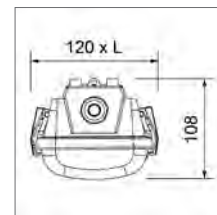

Variante	Länge	Leistung	Lichtstrom	Bestromung	EEK	Art.-Nr.	CHF
⏻	1170 mm	40 W	4700 lm	700 mA	D	185-160-41	159.00
⏻	1570 mm	55 W	7100 lm	1050 mA	C	185-162-41	179.00

Optional	Art.-Nr.	CHF
Multi-Konstantstrom-Treiber, 80 W, 700 mA / 1050 mA, DALI 2	UD-043-122-00	• 139.00
Notlichtelement, Selbsttest, 3h	UD-043-100-01	• 180.00
Multi-Konstantstrom-Treiber, 80 W, 700 mA / 1050 mA, DALI 2 + Notlichtelement, Selbsttest, 3h	UD-043-123-00	• 319.00

Zubehör	Art.-Nr.	CHF
Seilabhängung, 2000 mm, Ø 1.5 mm	100-004-003	16.00





## Storage LED | Hallenleuchte

robuste Effizienz

NEW



104 W, 152 W  
 12800 lm, 21100 lm  
 4000 K  
 CRI 80  
 Abstrahlwinkel: 90°  
 50'000h L70  
 1600 mA, 2400 mA  
 4.4 kg

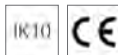
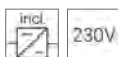
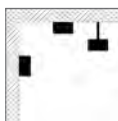

## Informationen

- Linsentechnik für eine optimale Lichtverteilung
- hohes Lumenpaket
- moderne, flache Bauform
- robuste Qualität aus Aluminium und Polycarbonat
- DALI (dimmbar 10-100%)
- mit 2 Anschlusskabel (1 x Strom, 3-polig / 1 x DALI, 2-polig), wir empfehlen 2 Kabelverbinder (30285-001-00)

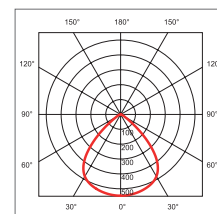
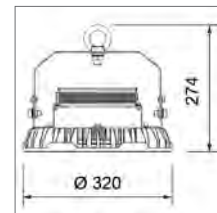

Variante	Leistung	Lichtstrom	Bestromung	Art.-Nr.	CHF
DALI	104 W	12800 lm	1600 mA	185-165-40	449.00
DALI	152 W	21100 lm	2400 mA	185-166-40	499.00



**Reflektor**  
Aluminium

Variante	Art.-Nr.	CHF
	185-165-99	59.00



**Reflektor**  
Polycarbonat

Variante	Art.-Nr.	CHF
	185-165-98	59.00



**Kabelverbinder**  
IP68, 3-polig, Ø: 23 mm, 0.5 – 4.0 mm<sup>2</sup>

Länge	Art.-Nr.	CHF
68 mm	30285-001-00	19.90





## Exit LED | Rettungszeichenleuchte

alles inklusive



3.5 W  
6000 K  
CRI 70  
40'000h L70

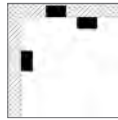

### Informationen

- homogene Leuchtdichtenverteilung
- EN1838: 30 m / VKF: 15 m
- manueller und semi-automatischer Selbsttest
- mit Einzelbatterie 3.6V Ni-Mh
- Aufladezeit: 24 Stunden
- Notbetrieb: 3 Stunden
- Bereitschafts- und Dauerschaltung
- enthaltene Piktogramme (je 2 Stk.):  
Pfeil nach links, Pfeil nach rechts,  
Pfeil nach unten
- 1 weisse Abdeckung ebenfalls inbegriffen
- Farbe: weiss, ~RAL 9016



Variante	Art.-Nr.	CHF
	185-001-60	269.00

Zubehör	Art.-Nr.	CHF
Wandhalterung, für seitliche Befestigung, weiss, ~RAL 9016	185-001-99	41.90
Einbaurahmen, weiss, ~RAL 9016	185-001-97	41.90
Piktogramm, Pfeil schräg nach unten	185-001-96	15.90
Piktogramm, Pfeil schräg nach oben	185-001-95	15.90

Ersatzteil	Art.-Nr.	CHF
Akku-Pack, Ni-Mh 3.6V	185-001-98	21.90

## Exit LED | Rettungszeichenleuchte

mit Seilabhangung



3.5 W  
6000 K  
CRI 70  
40'000h L70

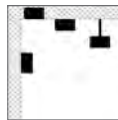

### Informationen

- homogene Leuchtdichtenverteilung
- EN1838: 30 m / VKF: 15 m
- manueller und semi-automatischer Selbsttest
- mit Einzelbatterie 3.6V Ni-Mh
- Aufladezeit: 24 Stunden
- Notbetrieb: 3 Stunden
- Bereitschafts- und Dauerschaltung
- enthaltene Piktogramme (je 2 Stk.):  
Pfeil nach links, Pfeil nach rechts,  
Pfeil nach unten
- 1 weisse Abdeckung ebenfalls inbegriffen
- Farbe: weiss, ~RAL 9016

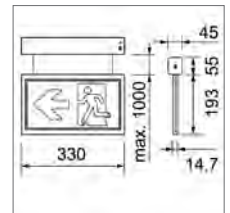

Variante	Art.-Nr.	CHF
	185-002-60	269.00

Zubehör	Art.-Nr.	CHF
Wandhalterung, für seitliche Befestigung, weiss, ~RAL 9016	185-001-99	41.90
Einbaurahmen, weiss, ~RAL 9016	185-001-97	41.90
Piktogramm, Pfeil schräg nach unten	185-001-96	15.90
Piktogramm, Pfeil schräg nach oben	185-001-95	15.90

Ersatzteil	Art.-Nr.	CHF
Akku-Pack, Ni-Mh 3.6V	185-001-98	21.90





## Eye LED | Möbeleinbauleuchte

setzt den Akzent

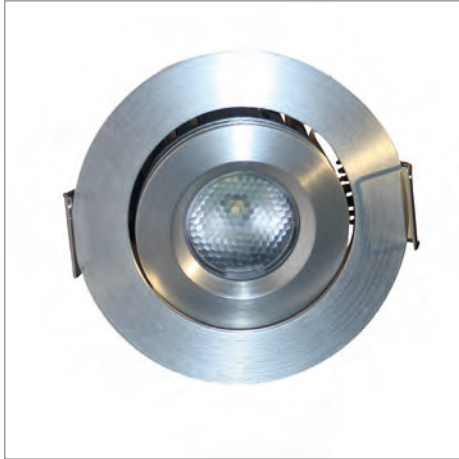
CRI  
90

### Informationen

- einfache Montage
- sehr geringe Einbautiefe
- integriertes und berechnetes Kühlmanagement
- 30° schwenkbar (2 x 15°)
- Leuchte aus Aluminium, gebürstet
- dimmbar DALI oder 1-10V auf Anfrage

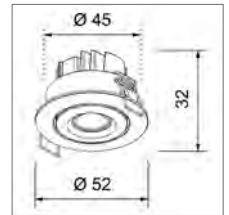

2.5 W

150 lm

3000 K

CRI 90

Abstrahlwinkel: 40°

30'000h L70

700 mA

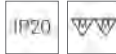
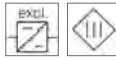
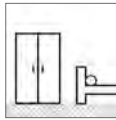
U<sub>F</sub> 3 – 6 V

Farbtemperatur

Art.-Nr.

CHF

3000 K

9321-008-70

36.90

Empfohlene Treiber

Seite

Art.-Nr.

CHF

 4 W, 700 mA, IP65

397

043-700-04

30.00

  10 W, 500 – 700 mA, rund, ab 2 Leuchten

402

200-019-010

74.00

## Vario LED | Möbeleinbauleuchte

Qualität in flachster Form

CRI  
90

NEW



### Informationen

- ultra-flach
- montagefreundliches Stecksystem
- mit Anschlusskabel (1.5 m, weiss) für Sechsfachverteiler
- Leuchte aus Aluminium
- IP44 von unten bei geschlossener Decke

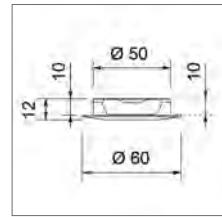

2.4 W  
160 lm  
3000 K  
CRI 90  
40'000h L70

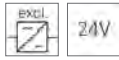
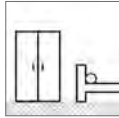

Farbe/Finish	Art.-Nr.	CHF
weiss, strukturiert, ~RAL 9003	170-020-70	34.90
alu-gebürstet	170-021-70	34.90

Zubehör	Art.-Nr.	CHF
Aufbaurahmen, weiss, strukturiert, ~RAL 9003	170-026-50	19.90
Aufbaurahmen, alu-gebürstet	170-026-55	19.90
Touch-Dimmer	23294-103-99	19.90
Tür-Sensor	23294-102-99	24.90

Empfohlene Treiber	Art.-Nr.	CHF
30 W	043-024-034	57.00

## Vario LED schwenkbar | Möbeleinbauleuchte

Qualität in flachster Form

CRI  
90

NEW



### Informationen

- ultra-flach
- montagefreundliches Stecksystem
- mit Anschlusskabel (1.5 m, weiss) für Sechsfachverteiler
- Leuchte aus Aluminium
- 15° schwenkbar
- 270° drehbar

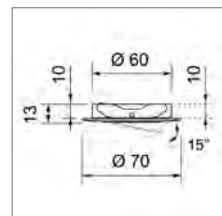

2.4 W  
160 lm  
3000 K  
CRI 90  
40'000h L70

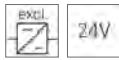
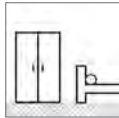

Farbe/Finish	Art.-Nr.	CHF
weiss, strukturiert, ~RAL 9003	170-023-70	39.90
alu-gebürstet	170-024-70	39.90

Zubehör	Art.-Nr.	CHF
Touch-Dimmer	23294-103-99	19.90
Tür-Sensor	23294-102-99	24.90

Empfohlene Treiber	Art.-Nr.	CHF
30 W	043-024-034	57.00

## 30 W | Konstantspannungs-Treiber

NEW



30 W

Flicker &lt;30%

L: 155 mm

B: 53 mm

H: 16 mm

PRI  
230VSEC  
24V

IP20

CE

## Informationen

- flache Bauform
- DC tauglich
- montagefreundliches Stecksystem
- mit Sekundär-Anschlusskabel (0.3 m) inkl. Stecker

Leistung	Art.-Nr.	CHF
30 W	043-024-034	57.00



## Netzkabel

weiss, 230 V ac Einspeisung, mit Schalter und Netzstecker, 230 V, 2 x 0.75 mm<sup>2</sup>, max. 2.5 A

Länge	Art.-Nr.	CHF
1500 mm	23294-105-89	9.00



## Verteiler, 6-fach

weiss, mit 1 m Kabel, max. 3 A, 6 – 24 V dc

Variante	Art.-Nr.	CHF
	23294-105-99	6.00

## Zubehör

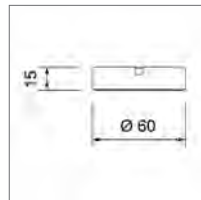

## Aufbaurahmen

Variante	Art.-Nr.	CHF
weiss, strukturiert, ~RAL 9003	170-026-50	19.90
alu-gebürstet	170-026-55	19.90

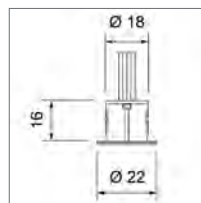

## Touch-Dimmer

48 W, PRI/SEC: 24 V, montagefreundliches Stecksystem, mit Anschlusskabel (1 m, weiss), Aluminium, Farbe: silber

Variante	Art.-Nr.	CHF
	23294-103-99	19.90



## Tür-Sensor

48 W, PRI/SEC: 24 V, montagefreundliches Stecksystem, mit Anschlusskabel (1 m, weiss), Erkennungsweite: 10 cm, Farbe: weiss

Variante	Art.-Nr.	CHF
	23294-102-99	24.90





**Leezy LED | Möbelaufbauleuchte**

dimmbar mit integriertem Treiber

**Informationen**

- mit Taster am Kopf
- dimmbar
- 90° schwenkbar
- 350° drehbar
- ohne sichtbare Schrauben
- Treiber integriert
- Farbe: weiss, ~RAL 9010
- Finish: strukturiert

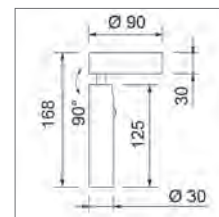

5 W

400 lm

3000 K

CRI 90

Abstrahlwinkel: 40°

30'000h L70



Variante



Art.-Nr.

116-058-70

CHF

119.00

**Flex II | Möbelaufbauleuchte**

robuste Flexible

**Informationen**

- flexible Leuchtenpositionierung
- Flexarm frei bewegbar
- ohne sichtbare Schrauben
- schönes filigranes Design
- inklusive Treiber (extern zu platzieren)
- Farbe: silber, ~RAL 9022

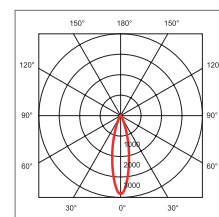
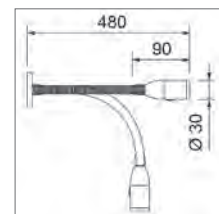

3.2 W

140 lm

4000 K

CRI 90

Abstrahlwinkel: 24°

25'000h L70

700 mA

U<sub>f</sub> 2.8 – 3.2 V

Variante



Art.-Nr.

170-012-41

CHF

89.00

## Smart – Das Möbelbeleuchtungs-System für Ein- und Aufbau



Die Schranktür öffnet sich, das Innere wird wie von Zauberhand erhellt – und zwar von einem Licht, das so angenehm und farbecht ist, dass Fehlgriffe bei der Kleiderauswahl der Vergangenheit angehören.

Die Montageanleitung kann auf unserer Website [www.unex-lighting.com](http://www.unex-lighting.com) heruntergeladen werden.



## Tablar – Das Tablarbeleuchtungs-System für maximale Flexibilität

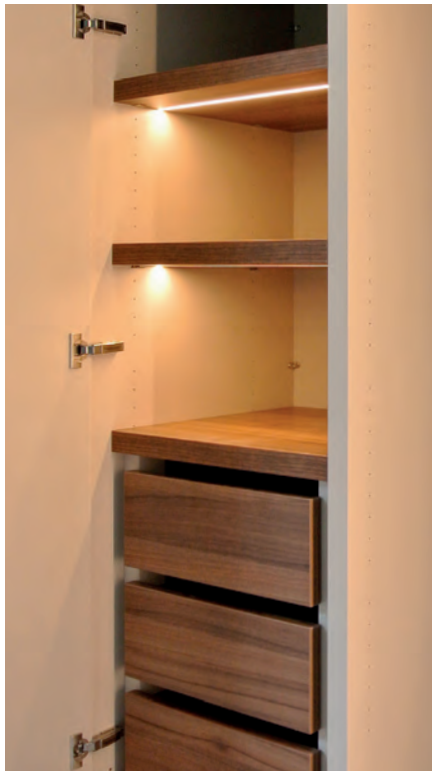

Das System Tablar zeichnet sich durch maximale Flexibilität aus. Tablare können nach Wunsch verstellt werden und leuchten sofort – ohne das weitere Eingriffe nötig sind.

Die Montageanleitung kann auf unserer Website [www.unex-lighting.com](http://www.unex-lighting.com) heruntergeladen werden.



## Smart für 1 Türe | Möbelbeleuchtungs-Set

CRI  
90

## Informationen

- hoher Farbwiedergabewert, CRI 90
- Ein-/Ausschaltung mit Magnetsensor und Permanent-Magnet
- der Kontaktabstand bei geschlossener Tür darf nicht grösser als 18 mm sein
- Plug & Play

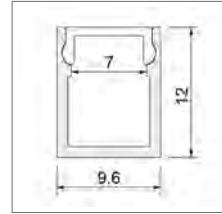

8.5 W/m  
850 lm/m  
140 LED/m  
2700 K  
CRI 90  
Abstrahlwinkel: 120°  
50'000h L70



Variante	Für Längen von	Art.-Nr.	CHF
⏻	– 500 mm	359-050-01	• 272.90
⏻	501 – 1000 mm	359-100-01	• 331.90
⏻	1001 – 1500 mm	359-150-01	• 384.00
⏻	1501 – 2000 mm	359-200-01	• 438.90
⏻	2001 – 2250 mm	359-225-01	• 492.50

## Smart für 2 Türen | Möbelbeleuchtungs-Set

CRI  
90

## Informationen

- hoher Farbwiedergabewert, CRI 90
- Ein-/Ausschaltung mit Magnetsensor und Permanent-Magnet
- der Kontaktabstand bei geschlossener Tür darf nicht grösser als 18 mm sein
- Plug & Play

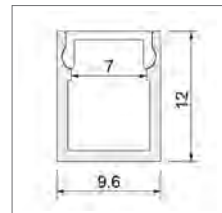

8.5 W/m  
850 lm/m  
140 LED/m  
2700 K  
CRI 90  
Abstrahlwinkel: 120°  
50'000h L70



Variante	Für Längen von	Art.-Nr.	CHF
⏻	– 500 mm	359-050-02	• 384.00
⏻	501 – 1000 mm	359-100-02	• 438.90
⏻	1001 – 1500 mm	359-150-02	• 492.50
⏻	1501 – 2000 mm	359-200-02	• 545.90
⏻	2001 – 2250 mm	359-225-02	• 604.50

## Smart für 3 Türen | Möbelbeleuchtungs-Set

CRI  
90

8.5 W/m

850 lm/m

140 LED/m

2700 K

CRI 90

Abstrahlwinkel: 120°

50'000h L70

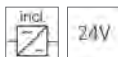

## Informationen

- hoher Farbwiedergabewert, CRI 90
- Ein-/Ausschaltung mit Magnetsensor und Permanent-Magnet
- der Kontaktabstand bei geschlossener Tür darf nicht grösser als 18 mm sein
- Plug & Play

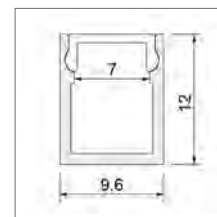

Variante	Für Längen von	Art.-Nr.	CHF
	– 500 mm	359-050-03	• 492.50
	501 – 1000 mm	359-100-03	• 545.90
	1001 – 1500 mm	359-150-03	• 604.50
	1501 – 2000 mm	359-200-03	• 658.00



## Befestigungsklammer

für Aufbau, 3 Stück pro Meter bestellen

Variante	Art.-Nr.	CHF
	26491-096-100	5.20



## Verlängerungskabel

Variante	Art.-Nr.	CHF
	AR-121-005-51	7.40

## Tablar für 1 Türe und 1 Tablar | Tablarbeleuchtungs-Set

CRI  
90

### Informationen

- hoher Farbwiedergabewert, CRI 90
- Ein-/Ausschaltung mit Magnetsensor und Permanent-Magnet
- der Kontaktabstand bei geschlossener Tür darf nicht grösser als 18 mm sein

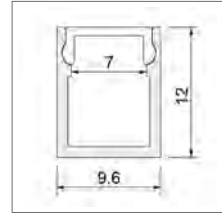

8.5 W/m  
850 lm/m  
140 LED/m  
2700 K  
CRI 90  
Abstrahlwinkel: 120°  
50'000h L70

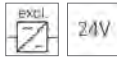
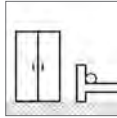

Für Längen von	Leistung (max.)	Art.-Nr.	CHF
– 512 mm	4.8 W	110-001-01	• 359.00
513 – 562 mm	5.3 W	110-002-01	• 369.90
563 – 762 mm	7.2 W	110-003-01	• 379.90
763 – 862 mm	8.2 W	110-004-01	• 389.90
863 – 962 mm	9.2 W	110-005-01	• 399.90
963 – 1162 mm	11.1 W	110-006-01	• 409.90
1163 – 1500 mm	14.4 W	110-007-01	• 420.90
1501 – 2000 mm	19.2 W	110-008-01	• 430.90

## Tablar für 2 Türe und 1 Tablar | Tablarbeleuchtungs-Set

CRI  
90

### Informationen

- hoher Farbwiedergabewert, CRI 90
- Ein-/Ausschaltung mit Magnetsensor und Permanent-Magnet
- der Kontaktabstand bei geschlossener Tür darf nicht grösser als 18 mm sein

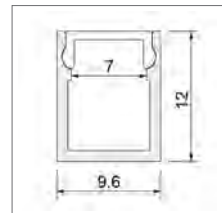

8.5 W/m  
850 lm/m  
140 LED/m  
2700 K  
CRI 90  
Abstrahlwinkel: 120°  
50'000h L70

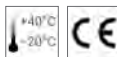
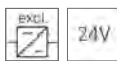
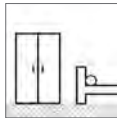

Für Längen von	Leistung (max.)	Art.-Nr.	CHF
– 512 mm	4.8 W	110-001-02	• 379.90
513 – 562 mm	5.3 W	110-002-02	• 389.90
563 – 762 mm	7.2 W	110-003-02	• 399.90
763 – 862 mm	8.2 W	110-004-02	• 409.90
863 – 962 mm	9.2 W	110-005-02	• 420.90
963 – 1162 mm	11.1 W	110-006-02	• 430.90
1163 – 1500 mm	14.4 W	110-007-02	• 439.90
1501 – 2000 mm	19.2 W	110-008-02	• 449.90

## Tablar für zusätzliche Tablare | Lichtschiene

CRI  
90

8.5 W/m

850 lm/m

140 LED/m

2700 K

CRI 90

Abstrahlwinkel: 120°

50'000h L70

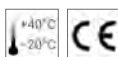
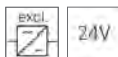

### Informationen

- hoher Farbwiedergabewert, CRI 90

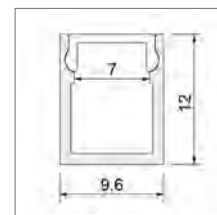

Für Längen von	Leistung (max.)	Art.-Nr.	CHF
- 512 mm	4.8 W	110-001-10	• 101.90
513 - 562 mm	5.3 W	110-002-10	• 111.90
563 - 762 mm	7.2 W	110-003-10	• 121.90
763 - 862 mm	8.2 W	110-004-10	• 132.90
863 - 962 mm	9.2 W	110-005-10	• 142.90
963 - 1162 mm	11.1 W	110-006-10	• 152.90
1163 - 1500 mm	14.4 W	110-007-10	• 162.90
1501 - 2000 mm	19.2 W	110-008-10	• 173.90

Empfohlene Treiber	Seite	Art.-Nr.	CHF
⏻ 60 W	386	MW-TNG-60-24	63.00
Netzkabel, 2500 mm, für MW-TNG-60-24		MW-AA-220-06-S	5.90
⏻ 90 W, 5000 mA	391	200-001-090	99.00
Stecker, schwarz, inkl. Montage an Treiber		772-521-050	• 31.00



### Magnetsensor

max. 1 A

Variante	Art.-Nr.	CHF
	3692-001-01	26.60



### Permanent-Magnet

Variante	Art.-Nr.	CHF
	CR-185-106-85	7.40



### Switch Box

Variante	Art.-Nr.	CHF
	110-100-99	59.00



## Aussenleuchten – Rund ums Haus



Wir machen Ihnen das Leben leichter



### Einfach anschliessen

Bei Erdspiess-, Bodeneinbau- und Pollerleuchten liefern wir ein robustes Anschlusskabel aus Gummi bereits mit.



### Durchdachte Einbetoniergehäuse

- Eine Holzplatte erleichtert die Befestigung an der Schalung und dient gleichzeitig als zusätzlicher Stabilisator für das Gehäuse.
- Ausbruchstellen erleichtern das Einführen der Installationsrohre.
- Auf der Rückseite sind Ausrichtungslinien um per Lasergerät eine genaue Anordnung mehrere Leuchten zu garantieren.
- Es ist genügend Platz für das Abschlaufen vorgesehen.



### Ideales Zubehör

Unser Kabelverbinder mit integriertem Wasserstop trägt zur Langlebigkeit der Leuchte bei und schützt diese selbst bei Kapillareffekt.



Die passende Lichtstimmung im Eingangsbereich und Garten Ihres Hauses mit den Design Aussenleuchten von unex lighting freut nicht nur den Besucher. Wo heute immer mehr Wert auf gepflegte Gärten, schöne Terrassen, Balkone und Lounges gelegt wird, spielt die Beleuchtung eine wichtige Rolle.

Wetterfeste LED Aussenleuchten gibt es in vielen verschiedenen Modellen und Farben. Eine angenehme Beleuchtung im Aussenbereich lädt zum Verweilen auf Terrasse, Balkon & Co ein.

Die LED Aussenleuchten von unex lighting sind robust, wetterfest und mit IP Schutz versehen. Alle sind in unseren Labors getestet.

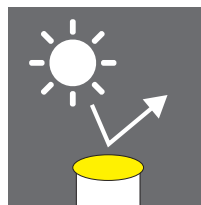

UV-beständig  
(inkl. Einspeisung)

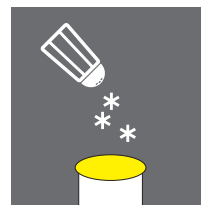

Salzbeständig  
(Korrosion, Alterung)

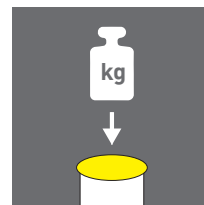

IK08

## Flexible Bandleuchten für den Aussenbereich

Im Kapitel **Flexible Bandleuchten** ab Seite 104 finden Sie weitere Möglichkeiten Aussenbereiche zu beleuchten.

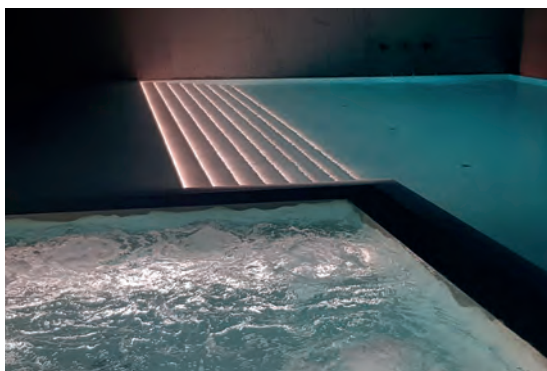

Der Einfluss des Wetters belastet die Technik in besonderem Masse. Hochwertige Materialien und zuverlässig Technik reichen aber meist nicht aus. Anwendungs-Know-how ist genauso Pflicht für einen reibungslosen, langen Betrieb der Leuchten.



PDF  
Montagehinweise.





**Polar LED**  Ø 80 mm | **Einbau-Downlight**

der schwenkbare in IP65 rundum



9.5 W

850 lm

3000 K

CRI 80

Abstrahlwinkel: 40°

50'000h L70



260 mA

U<sub>F</sub> 34 – 36 V**Informationen**

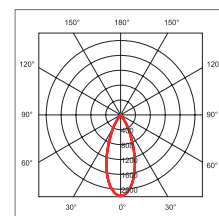
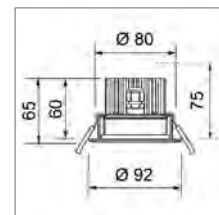
- ersetzt ein 50 Watt Halogen-Leuchtmittel
- geringe Einbautiefe
- 30° schwenkbar (2 x 15°)
- Farbe: weiss, ~RAL 9016
- Finish: pulverbeschichtet
- Der LED-Treiber muss in ein IP geschütztes Einbaugehäuse oder einen geschützten Schaltschrank platziert werden



Farbtemperatur	Art.-Nr.	CHF
3000 K	180-214-70	114.00

Empfohlene Treiber	Seite	Art.-Nr.	CHF
 12 W, 260 mA	398	043-260-12	48.00
 12 W, 180 – 500 mA	403	043-001-012	69.00

Zubehör	Art.-Nr.	CHF
Verteilerbox, IP67	290-102-00	49.90

**Polar LED**  Ø 90 – 100 mm | **Einbau-Downlight**

der schwenkbare in IP65 rundum



9.5 W

850 lm

3000 K

CRI 80

Abstrahlwinkel: 40°

50'000h L70

260 mA

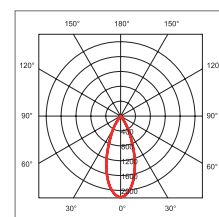
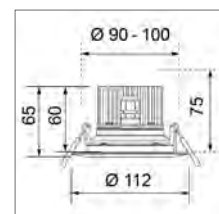

U<sub>F</sub> 34 – 36 V**Informationen**

- ersetzt ein 50 Watt Halogen-Leuchtmittel
- geringe Einbautiefe
- 30° schwenkbar (2 x 15°)
- Farbe: weiss, ~RAL 9016
- Finish: pulverbeschichtet
- Der LED-Treiber muss in ein IP geschütztes Einbaugehäuse oder einen geschützten Schaltschrank platziert werden



Empfohlenes Einbetoniergehäuse von  
AGRO AG / Kaiser: 920 858 359  
Frontring: 920 896 409

Farbtemperatur	Art.-Nr.	CHF
3000 K	180-215-70	124.00

Empfohlene Treiber	Seite	Art.-Nr.	CHF
 12 W, 260 mA	398	043-260-12	48.00
 12 W, 180 – 500 mA	403	043-001-012	69.00

Zubehör	Art.-Nr.	CHF
Verteilerbox, IP67	290-102-00	49.90





## Cilindro Outdoor LED Ø 80 mm | Aufbau-Downlight

kompakte Qualität



20.5 W  
1700 lm  
3000 K  
CRI 80  
Abstrahlwinkel: 36°  
50'000h L70  
500 mA  
U<sub>F</sub> 35 – 36 V

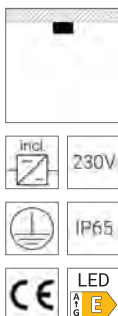

### Informationen

- ohne sichtbare Schrauben
- einfache Montage
- Leuchte aus Aluminium
- Farbe: anthrazit, ~RAL 7016

passend zu  
Aufbau-Downlight Cilindro LED, S. 215

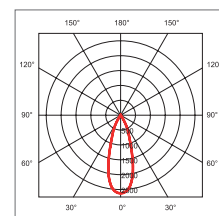
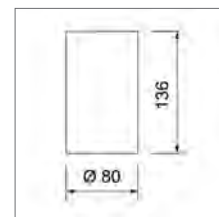

Variante	Art.-Nr.	CHF
	25817-051-72	299.00

Zubehör	Art.-Nr.	CHF
Reflektor, 20°	25817-041-98	19.00
Reflektor, 50°	25817-041-97	19.00

## Cilindro Outdoor LED Ø 110 mm | Aufbau-Downlight

kompakte Qualität



28.5 W  
2850 lm  
3000 K  
CRI 80  
Abstrahlwinkel: 40°  
50'000h L70  
700 mA  
U<sub>F</sub> 35 – 37 V

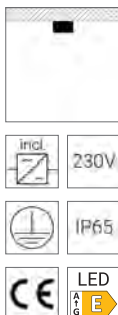

### Informationen

- ohne sichtbare Schrauben
- einfache Montage
- Leuchte aus Aluminium
- Farbe: anthrazit, ~RAL 7016

passend zu  
Aufbau-Downlight Cilindro LED, S. 215

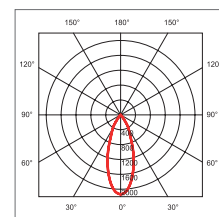
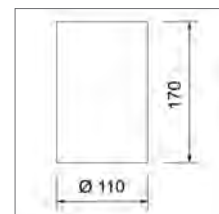

Variante	Art.-Nr.	CHF
	25817-052-72	379.00

Zubehör	Art.-Nr.	CHF
Reflektor, 10°	180-251-90	24.00







## Venus Round LED | Aufbau-Downlight

NEW



## Informationen

- schönes Lichtbild
- Leuchte aus Aluminium
- Farbe: anthrazit, ~RAL 7016
- Finish: pulverbeschichtet

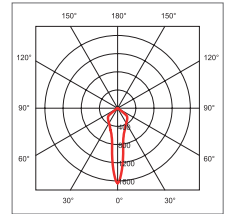
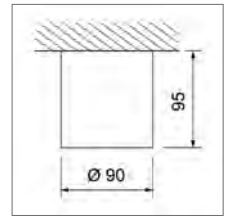

9 W

600 lm

3000 K

CRI 80

Abstrahlwinkel: 19°

50'000h L70

700 mA

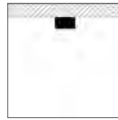

Variante



Art.-Nr.

26524-009-71

CHF

169.00

## Venus Square LED | Aufbau-Downlight

NEW



## Informationen

- schönes Lichtbild
- Leuchte aus Aluminium
- Farbe: anthrazit, ~RAL 7016
- Finish: pulverbeschichtet

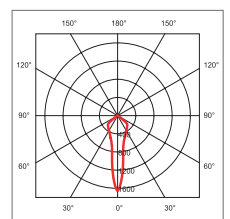
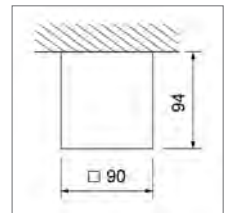

9 W

600 lm

3000 K

CRI 80

Abstrahlwinkel: 19°

50'000h L70

700 mA

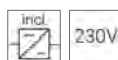

Variante



Art.-Nr.

26524-010-71

CHF

169.00



## L8 Rondo | Wandeinbauleuchte

Top in Lichttechnik und Sichtbeton

NEW

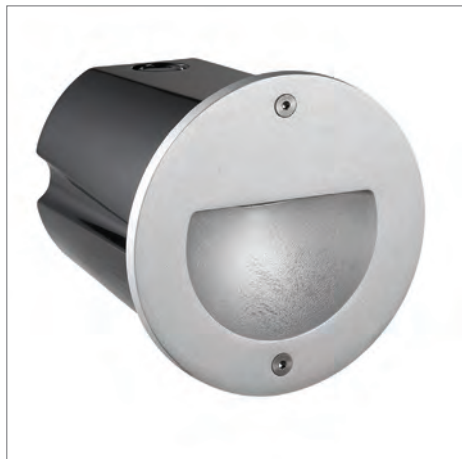

### Informationen

- geeignet für Sichtbeton
- von 3000 auf 2700 Kelvin umschaltbar
- asymmetrischer Lichtaustritt
- Leuchte aus Aluminium
- Finish: pulverbeschichtet
- Serienverkabelung möglich

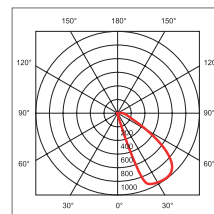
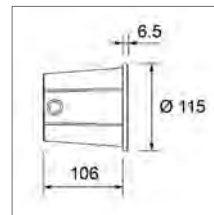

1.7 W
40 lm
3000/2700 K switchable
CRI 80
50'000h L80
350 mA

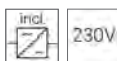
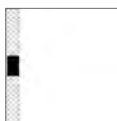

Variante	Farbe	Art.-Nr.	CHF
	silbergrau, ~RAL 9006	25817-005-71	139.00
	anthrazit, ~RAL 7016	25817-072-71	139.00

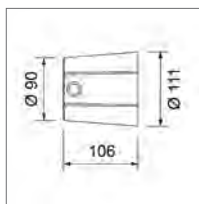

### Einbetoniergehäuse

Kunststoff, geeignet für Sichtbeton

Variante	Art.-Nr.	CHF
	25817-005-99	39.00

**L8 Mini | Wandinbauleuchte**

Top in Lichttechnik und Sichtbeton

**NEW****Informationen**

- geeignet für Sichtbeton
- von 3000 auf 2700 Kelvin umschaltbar
- asymmetrischer Lichtaustritt
- Leuchte aus Aluminium
- Finish: pulverbeschichtet
- Seri verkabelung möglich

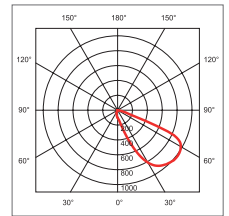
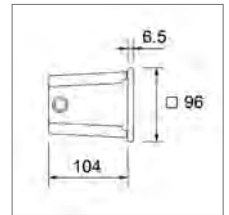

1.7 W  
 45 lm  
 3000/2700 K switchable  
 CRI 80  
 50'000h L80  
 350 mA

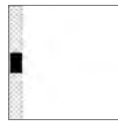

Variante	Farbe	Art.-Nr.	CHF
	silbergrau, ~RAL 9006	25817-003-71	139.00
	anthrazit, ~RAL 7016	25817-055-71	139.00

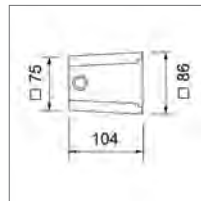
**Einbetoniergehäuse**

Kunststoff, geeignet für Sichtbeton

Variante	Art.-Nr.	CHF
	25817-003-99	39.00

## LUV II | Wandinbauleuchte

NEW



## Informationen

- geeignet für Sichtbeton
- homogenes Licht
- von 3000 auf 2700 Kelvin umschaltbar
- Leuchte aus Aluminium
- Finish: pulverbeschichtet
- Serienverkabelung möglich

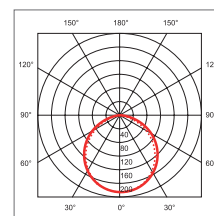
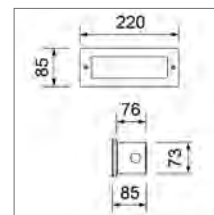

1.7 W
90 lm
3000/2700 K switchable
CRI 80
50'000h L70
350 mA

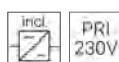
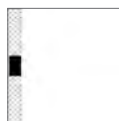

Variante	Farbe	Art.-Nr.	CHF
⏻	silbergrau, ~RAL 9006	25817-001-72	159.00
⏻	anthrazit, ~RAL 7016	25817-071-72	159.00

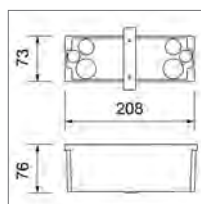

## Einbetoniergehäuse

Kunststoff, geeignet für Sichtbeton

Variante	Art.-Nr.	CHF
	25817-001-99	39.00

# LUV Asym II | Wandeinbauleuchte

**NEW**



### Informationen

- geeignet für Sichtbeton
- asymmetrischer Lichtaustritt
- von 3000 auf 2700 Kelvin umschaltbar
- Leuchte aus Aluminium
- Finish: pulverbeschichtet
- Seri verkabelung möglich

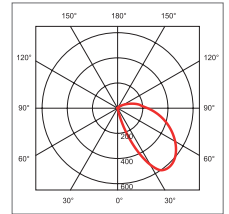
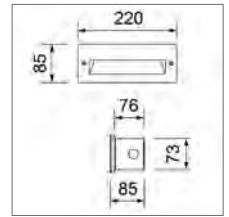

3 W
60 lm, 40 lm
3000/2700 K switchable
CRI 80
50'000h L70
350 mA

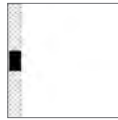

Variante	Farbe	Lichtstrom	Art.-Nr.	CHF
	silbergrau, ~RAL 9006	60 lm	180-240-70	159.00
	anthrazit, ~RAL 7016	40 lm	180-241-70	159.00

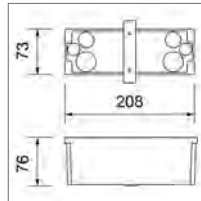

### Einbetoniergehäuse

Kunststoff, geeignet für Sichtbeton

Variante	Art.-Nr.	CHF
	25817-001-99	39.00





## L9 II | Wandeinbauleuchte

**NEW**



### Informationen

- geeignet für Sichtbeton
- asymmetrischer Lichtaustritt
- von 3000 auf 2700 Kelvin umschaltbar
- Leuchte aus Aluminium
- Finish: pulverbeschichtet

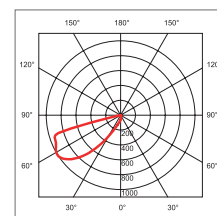
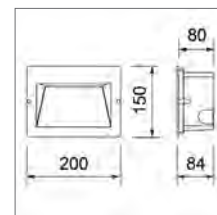

11 W
400 lm, 320 lm
3000/2700 K switchable
CRI 80
Abstrahlwinkel: 100°
50'000h L80
500 mA

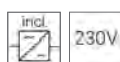

Variante	Farbe	Lichtstrom	Art.-Nr.	CHF
◀ R.C.	silbergrau, ~RAL 9006	400 lm	180-218-71	244.00
◀ R.C.	anthrazit, ~RAL 7016	320 lm	180-204-71	244.00

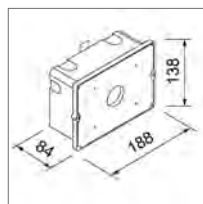

### Einbetoniergehäuse

Kunststoff, geeignet für Sichtbeton

Variante	Art.-Nr.	CHF
	180-204-99	49.00



### Deko-Rahmen

Edelstahl, gebürstet

Variante	Art.-Nr.	CHF
	180-204-98	29.00

## Tura LED Ø 180 mm | Decken- und Wandaufbauleuchte

Qualität und Umwelt



4 W  
320 lm, 340 lm  
3000/2700 K switchable  
CRI 80  
Abstrahlwinkel: 120°  
50'000h L70  
200 mA

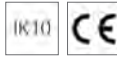
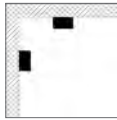

### Informationen

- Leuchte aus Alu-Druckguss
- mit UV-beständiger Kunststoffabdeckung (PC)
- von 3000 auf 2700 Kelvin umschaltbar
- einfache Montage
- rückseitige Kabelzuführung oder Aufputz
- Serienverkabelung möglich
- Farbe: anthrazit, ~RAL 7016
- Finish: pulverbeschichtet

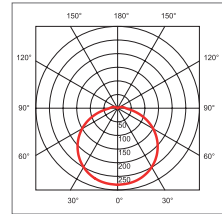
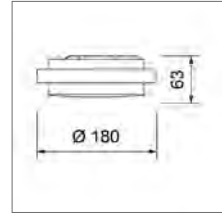

### Variante



### Art.-Nr.

180-235-70

### CHF

159.00

## Tura LED Ø 235 mm | Decken- und Wandaufbauleuchte

Qualität und Umwelt



8 W  
630 lm, 670 lm  
3000/2700 K switchable  
CRI 80  
Abstrahlwinkel: 120°  
50'000h L70  
350 mA

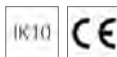
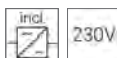
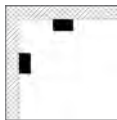

### Informationen

- Leuchte aus Alu-Druckguss
- mit UV-beständiger Kunststoffabdeckung (PC)
- von 3000 auf 2700 Kelvin umschaltbar
- einfache Montage
- rückseitige Kabelzuführung oder Aufputz
- Serienverkabelung möglich
- Farbe: anthrazit, ~RAL 7016
- Finish: pulverbeschichtet

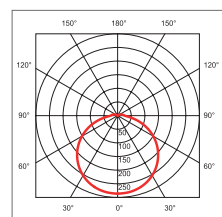
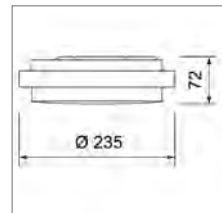

### Variante



### Art.-Nr.

180-236-70

### CHF

209.00

**Tura LED Ø 290 mm | Decken- und Wandaufbauleuchte**

NEW

Qualität und Umwelt

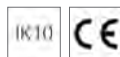
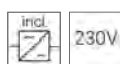
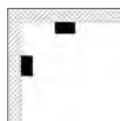

14 W  
1190 lm, 1230 lm  
3000/2700 K switchable  
CRI 80  
Abstrahlwinkel: 120°  
50'000h L70  
350 mA

**Informationen**

- Leuchte aus Alu-Druckguss
- mit UV-beständiger Kunststoffabdeckung (PC)
- von 3000 auf 2700 Kelvin umschaltbar
- einfache Montage
- rückseitige Kabelzuführung oder Aufputz
- Serienvorkabelung möglich
- Farbe: anthrazit, ~RAL 7016
- Finish: pulverbeschichtet

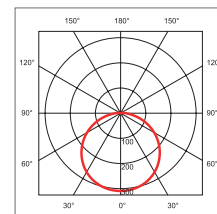
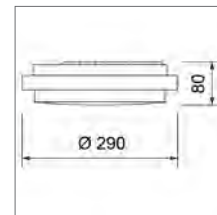
**Variante****Art.-Nr.**

180-239-70

**CHF**

259.00

**Tura Square LED | Decken- und Wandaufbauleuchte**

NEW

Qualität und Umwelt

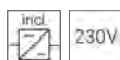
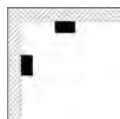

7.5 W  
650 lm, 600 lm  
3000/2700 K switchable  
CRI 80  
Abstrahlwinkel: 120°  
50'000h L70  
350 mA

**Informationen**

- Leuchte aus Alu-Druckguss
- mit UV-beständiger Kunststoffabdeckung (PC)
- von 3000 auf 2700 Kelvin umschaltbar
- einfache Montage
- rückseitige Kabelzuführung oder Aufputz
- Serienvorkabelung möglich
- Farbe: anthrazit, ~RAL 7016
- Finish: pulverbeschichtet

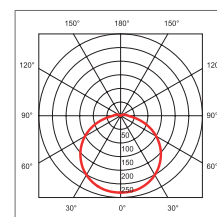
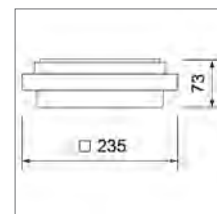
**Variante****Art.-Nr.**

180-238-70

**CHF**

229.00





## Plate Round LED | Decken- und Wandaufbauleuchte

flach, elegant, hochwertig

NEW



### Informationen

- Leuchte aus Alu-Druckguss
- mit UV-beständiger Kunststoffabdeckung (PC)
- Farbe: anthrazit, ~RAL 7016
- HF-Sensor-Variante:
  - Erkennungsweite 8 – 14 m
  - Erfassungswinkel 140°
  - Sensor Parameter einstellbar
  - Korridor-Funktion

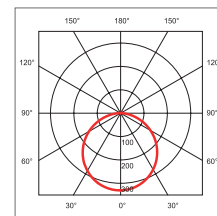
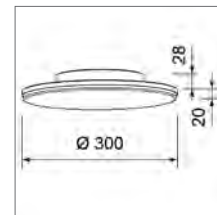

17 W, 19 W

1200 lm, 1360 lm

3000 K

CRI 80

Abstrahlwinkel: 120°

50'000h L70

300 mA, 350 mA

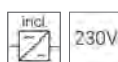
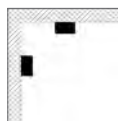

Variante	Leistung	Lichtstrom	Bestromung	Art.-Nr.	CHF
	19 W	1360 lm	350 mA	180-222-72	209.00
	17 W	1200 lm	300 mA	180-223-71	259.00

## Plate Square LED | Decken- und Wandaufbauleuchte

flach, elegant, hochwertig

NEW



### Informationen

- Leuchte aus Alu-Druckguss
- mit UV-beständiger Kunststoffabdeckung (PC)
- Farbe: anthrazit, ~RAL 7016
- HF-Sensor-Variante:
  - Erkennungsweite 8 – 14 m
  - Erfassungswinkel 140°
  - Sensor Parameter einstellbar
  - Korridor-Funktion

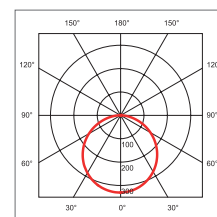
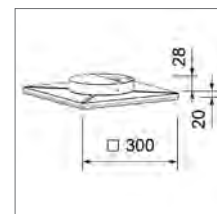

17 W, 19 W

1250 lm, 1400 lm

3000 K

CRI 80

Abstrahlwinkel: 120°

50'000h L70

300 mA, 350 mA

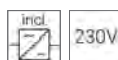
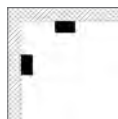

Variante	Leistung	Lichtstrom	Bestromung	Art.-Nr.	CHF
	19 W	1400 lm	350 mA	180-220-72	209.00
	17 W	1250 lm	300 mA	180-221-71	259.00











## Zaky Mono LED | Decken- und Wandaufbauleuchte

formschöne Sicherheit



10 W  
800 lm  
3000 K  
CRI 80  
Abstrahlwinkel: 60°  
40'000h L70

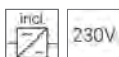
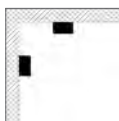

### Informationen

- Leuchtenkopfposition einstellbar
- einfache Montage
- elegante Bauform
- Leuchte aus Aluminium
- Farbe: anthrazit, ~RAL 7024

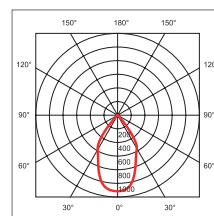
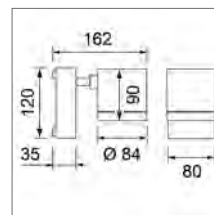

### Variante



### Art.-Nr.

116-062-70

### CHF

169.00

## Zaky Mono LED Sensor | Decken- und Wandaufbauleuchte

formschöne Sicherheit



10 W  
800 lm  
3000 K  
CRI 80  
Abstrahlwinkel: 60°  
40'000h L70

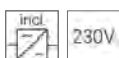
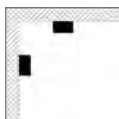

### Informationen

- integrierter PIR-Sensor mit individuell einstellbaren Parametern
- Leuchtenkopfposition einstellbar
- einfache Montage
- elegante Bauform
- Leuchte aus Aluminium
- Farbe: anthrazit, ~RAL 7024

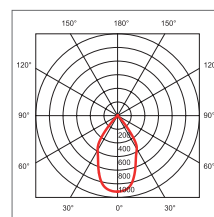
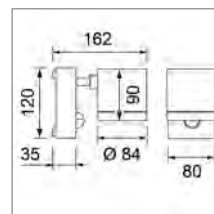

### Variante



### Art.-Nr.

116-061-70

### CHF

209.00

**Zaky LED | Decken- und Wandaufbauleuchte**

formschöne Sicherheit

NEW

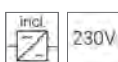
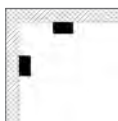

2 x 10 W  
2 x 700 lm  
3000 K  
CRI 80  
Abstrahlwinkel: 60°  
40'000h L70

**Informationen**

- Leuchtenkopfposition einstellbar
- einfache Montage
- elegante Bauform
- Leuchte aus Aluminium
- Farbe: anthrazit, ~RAL 7024

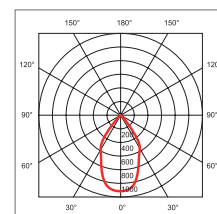
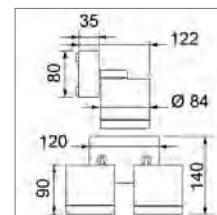
**Variante****Art.-Nr.**

116-060-71

**CHF**

269.00

**Zaky LED Sensor | Decken- und Wandaufbauleuchte**

formschöne Sicherheit

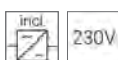
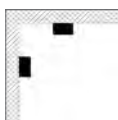

2 x 10 W  
2 x 800 lm  
3000 K  
CRI 80  
Abstrahlwinkel: 60°  
40'000h L70

**Informationen**

- integrierter PIR-Sensor mit individuell einstellbaren Parametern
- Leuchtenkopfposition einstellbar
- einfache Montage
- elegante Bauform
- Leuchte aus Aluminium
- Farbe: anthrazit, ~RAL 7024

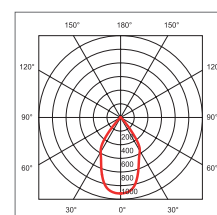
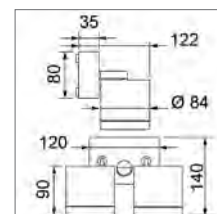
**Variante****Art.-Nr.**

116-059-70

**CHF**

319.00



## Tera II 1XGU10 LED | Wandaufbauleuchte

Zeitlos gut

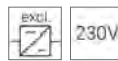
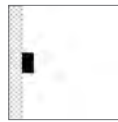

### Informationen

- ohne Leuchtmittel GU10
- max. 1 x 10 W (LED)
- gute Entblendung
- Leuchte aus Aluminium
- Farbe: anthrazit, ~RAL 7016
- Finish: pulverbeschichtet

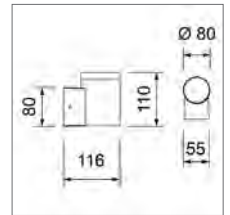

Variante	Art.-Nr.	CHF
	180-310-50	99.00

Leuchtmittlempfehlung	Lichtsteuerung	Seite
Unex Lamp GU10		196

## Tera II 2XGU10 LED | Wandaufbauleuchte

Zeitlos gut

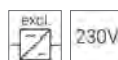

### Informationen

- ohne Leuchtmittel GU10
- max. 2 x 10 W (LED)
- gute Entblendung
- mit Direkt-/Indirektlicht
- Leuchte aus Aluminium
- Farbe: anthrazit, ~RAL 7016
- Finish: pulverbeschichtet

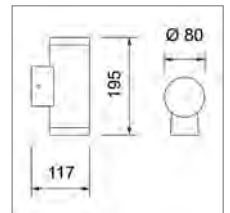

Variante	Art.-Nr.	CHF
	180-308-50	139.00

Leuchtmittlempfehlung	Lichtsteuerung	Seite
Unex Lamp GU10		196





**Tera II LED Ø 80 mm | Wandaufbauleuchte**

Zeitlos gut

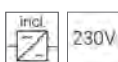
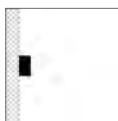

15 W  
1300 lm  
3000 K  
CRI 80  
Abstrahlwinkel: 24°  
50'000h L70  
350 mA

**Informationen**

- gute Entblendung
- indirekt 50 %, direkt 50 %
- Leuchte aus Aluminium
- Farbe: anthrazit, ~RAL 7016
- Finish: pulverbeschichtet

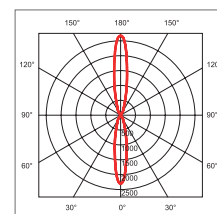
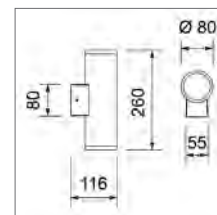
**Variante****Art.-Nr.****CHF**

180-250-70

319.00

**Zubehör****Art.-Nr.****CHF**

Reflektor, 15°

180-250-90

19.00

Reflektor, 36°

180-250-91

19.00

**Tera II LED Ø 110 mm | Wandaufbauleuchte**

Zeitlos gut

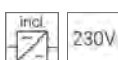
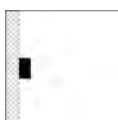

30 W  
2600 lm  
3000 K  
CRI 80  
Abstrahlwinkel: 20°  
50'000h L70  
350 mA

**Informationen**

- gute Entblendung
- indirekt 50 %, direkt 50 %
- Leuchte aus Aluminium
- Farbe: anthrazit, ~RAL 7016
- Finish: pulverbeschichtet

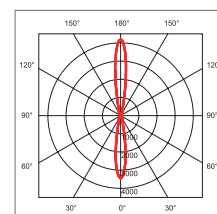
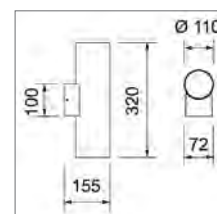
**Variante****Art.-Nr.****CHF**

180-251-70

479.00

**Zubehör****Art.-Nr.****CHF**

Reflektor, 10°

180-251-90

24.00

Reflektor, 40°

180-251-91

24.00





## Tom Round II LED | Wandaufbauleuchte

Lichtfarbe wählbar, dimmbar, rasch montiert



11.5 W

270 lm / 300 lm

3000/2700 K switchable

CRI 80

Abstrahlwinkel: 360°

50'000h L70

500 mA

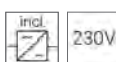
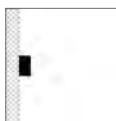

### Informationen

- rotationssymmetrischer Lichtaustritt
- von 3000 auf 2700 Kelvin umschaltbar
- hochwertige Materialien
- Leuchte aus Aluminium
- Farbe: anthrazit, ~RAL 7016
- Finish: pulverbeschichtet
- Serienverkabelung möglich

passend zu

Pollerleuchte Tom Round II LED, S. 374

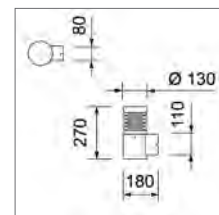

Variante	Art.-Nr.	CHF
 RC	180-302-70	349.00

Zubehör	Art.-Nr.	CHF
Abdeckung	180-305-95	31.00

## Evida Round II LED | Wandaufbauleuchte

flach mit integriertem Treiber



### Informationen

- asymmetrischer Lichtaustritt
- geringe Aufbauhöhe
- von 3000 auf 2700 Kelvin umschaltbar
- Finish: pulverbeschichtet
- Serienverkabelung möglich

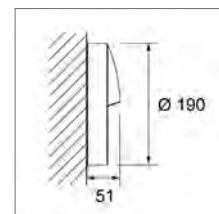

NEW

7.5 W

300 lm, 280 lm

3000/2700 K switchable

CRI 80

Abstrahlwinkel: 100°

50'000h L70

500 mA

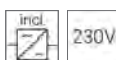
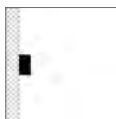

Variante	Farbe	Lichtstrom	Art.-Nr.	CHF
	silbergrau, ~RAL 9006	300 lm	25817-030-71	224.00
	anthrazit, ~RAL 7016	280 lm	25817-053-71	224.00





## Lim Outdoor LED | Wandaufbauleuchte

schön und dimmbar

CRI  
90

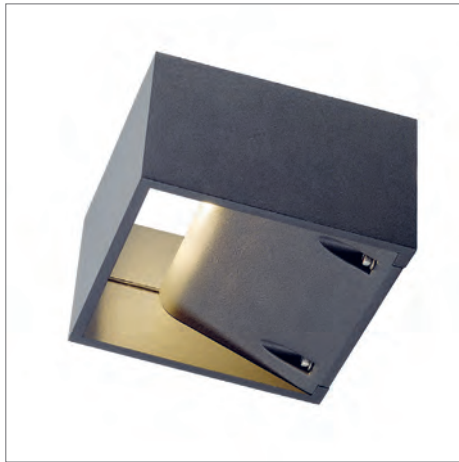

### Informationen

- dekorativer Lichteffekt
- von 3000 auf 2700 Kelvin umschaltbar
- Leuchte aus Aluminium
- Finish: pulverbeschichtet
- DALI auf Anfrage

passend zu  
Wandaufbauleuchte Lim, S. 261  
Pollerleuchte Lim LED, S. 379

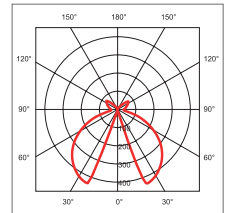
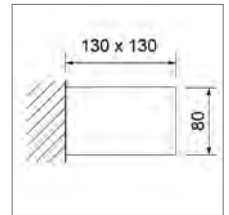

9 W  
380 lm – 620 lm  
3000/2700 K switchable  
CRI 90  
Abstrahlwinkel: 120°  
40'000h L70



Variante	Farbe	2700 K	3000 K	Art.-Nr.	CHF
▲ R.C.	weiss, ~RAL 9003	570 lm	620 lm	116-035-72	269.00
▲ R.C.	grau, ~RAL 7042	420 lm	460 lm	116-036-72	269.00
▲ R.C.	anthrazit, ~RAL 7024	380 lm	420 lm	116-045-72	269.00

Zubehör	Art.-Nr.	CHF
Abdeckung für Lichteffect, weiss	116-044-50	31.00
Abdeckung für Lichteffect, grau	116-043-96	31.00
Abdeckung für Lichteffect, anthrazit	116-046-52	31.00
Abdeckung, für 1-seitigen Lichtaustritt, anthrazit	116-042-52	31.00

## Lim Outdoor Cube LED | Wandaufbauleuchte

setzt Akzente



### Informationen

- dekorativer Lichteffect
- Leuchte aus Aluminium
- Finish: pulverbeschichtet

passend zu  
Wandaufbauleuchte Lim, S. 261  
Pollerleuchte Lim LED, S. 379

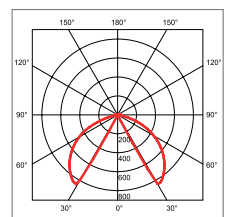
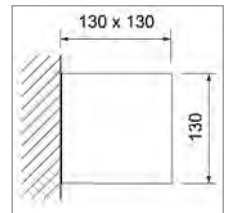

9 W  
380 lm, 750 lm  
3000 K  
CRI 80  
Abstrahlwinkel: 100°  
40'000h L70



Variante	Farbe	Lichtstrom	Art.-Nr.	CHF
▲ R.C.	weiss, ~RAL 9003	750 lm	116-048-70	319.00
▲ R.C.	anthrazit, ~RAL 7024	380 lm	116-049-70	319.00

Zubehör	Art.-Nr.	CHF
Abdeckung für Lichteffect, anthrazit	116-046-52	31.00
Abdeckung, für einseitigen Lichtaustritt, anthrazit	116-042-52	31.00





### Square LED | Wandaufbauleuchte

klar in Design und Licht

NEW



#### Informationen

- gute Entblending
- Leuchte aus Aluminium
- Farbe: anthrazit, ~RAL 7016
- Finish: pulverbeschichtet

passend zu  
Pollerleuchte Square LED, S. 379

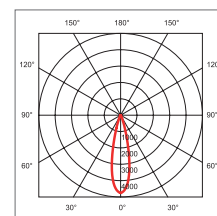
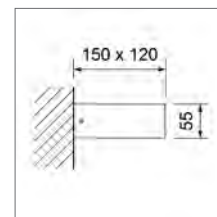

8 W  
650 lm  
3000 K  
CRI 80  
Abstrahlwinkel: 24°  
50'000h L70  
350 mA



Variante	Art.-Nr.	CHF
	26524-008-71	169.00

### Evida Square II LED | Wandaufbauleuchte

flach mit integriertem Treiber

NEW

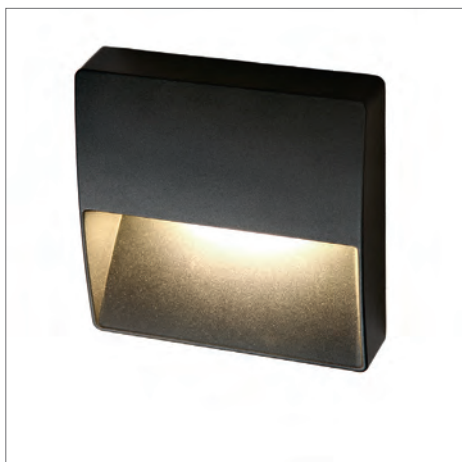

#### Informationen

- asymmetrischer Lichtaustritt
- geringe Aufbauhöhe
- von 3000 auf 2700 Kelvin umschaltbar
- Finish: pulverbeschichtet
- Seri verkabelung möglich

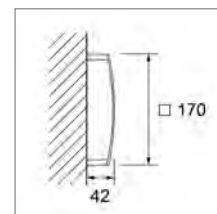

7.5 W  
300 lm, 280 lm  
3000/2700 K switchable  
CRI 80  
Abstrahlwinkel: 100°  
50'000h L70  
500 mA

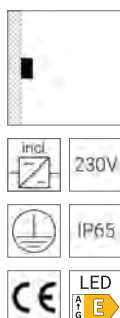

Variante	Farbe	Lichtstrom	Art.-Nr.	CHF
	silbergrau, ~RAL 9006	300 lm	25817-031-71	224.00
	anthrazit, ~RAL 7016	280 lm	25817-054-71	224.00



**Coppo LED 220 mm, 1-seitiger Lichtaustritt | Wandaufbauleuchte****CRI  
90**

cleanes Design in bester Materialisierung

**Informationen**

- klares und flaches Design
- hochwertige Materialien (Aluminium und Glas)
- von 3000 auf 2700 Kelvin umschaltbar
- Farbe: anthrazit, ~RAL 7016
- Finish: pulverbeschichtet
- Serienverkabelung möglich

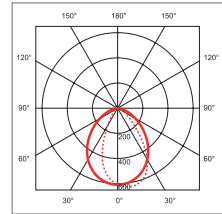
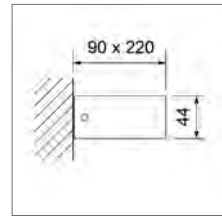

7.5 W  
290 lm / 300 lm  
3000/2700 K switchable  
CRI 90  
50'000h L70  
350 mA

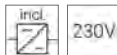
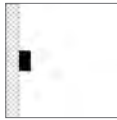
**Variante****Art.-Nr.**

180-312-70

**CHF**

209.00

**Coppo LED 220 mm, 2-seitiger Lichtaustritt | Wandaufbauleuchte****CRI  
90**

cleanes Design in bester Materialisierung

**Informationen**

- klares und flaches Design
- hochwertige Materialien (Aluminium und Glas)
- von 3000 auf 2700 Kelvin umschaltbar
- Farbe: anthrazit, ~RAL 7016
- Finish: pulverbeschichtet
- Serienverkabelung möglich

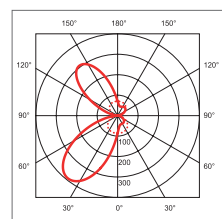
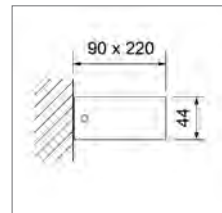

7.5 W  
250 lm / 265 lm  
3000/2700 K switchable  
CRI 90  
50'000h L70  
350 mA

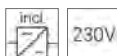
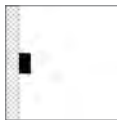
**Variante****Art.-Nr.**

180-313-70

**CHF**

209.00

**Coppo LED 280 mm, 1-seitiger Lichtaustritt | Wandaufbauleuchte**

cleanes Design in bester Materialisierung

**CRI  
90****Informationen**

- klares und flaches Design
- hochwertige Materialien (Aluminium und Glas)
- von 3000 auf 2700 Kelvin umschaltbar
- Farbe: anthrazit, ~RAL 7016
- Finish: pulverbeschichtet
- Seri verkabelung möglich

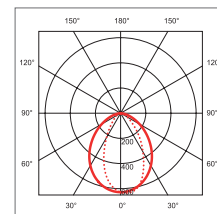
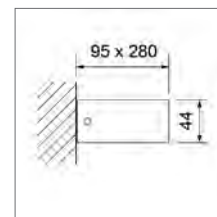

14 W

570 lm / 580 lm

3000/2700 K switchable

CRI 90

50'000h L70

350 mA

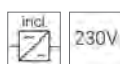
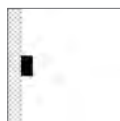

Variante



Art.-Nr.

CHF

180-314-70

259.00

**Coppo LED 280 mm, 2-seitiger Lichtaustritt | Wandaufbauleuchte**

cleanes Design in bester Materialisierung

**CRI  
90****Informationen**

- klares und flaches Design
- hochwertige Materialien (Aluminium und Glas)
- von 3000 auf 2700 Kelvin umschaltbar
- Farbe: anthrazit, ~RAL 7016
- Finish: pulverbeschichtet
- Seri verkabelung möglich

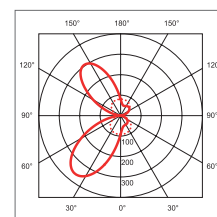
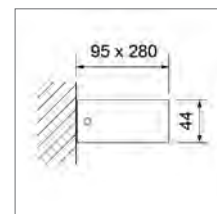

14 W

530 lm / 545 lm

3000/2700 K switchable

CRI 90

50'000h L70

350 mA

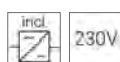

Variante



Art.-Nr.

CHF

180-315-70

259.00





**Turn LED | Wandaufbauleuchte**

kompakt, kraftvoll, einstellbar

**NEW****Informationen**

- 120° schwenkbar
- Leuchte aus Aluminium
- Farbe: anthrazit, ~RAL 7016
- Finish: pulverbeschichtet

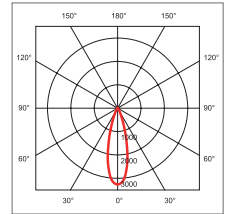
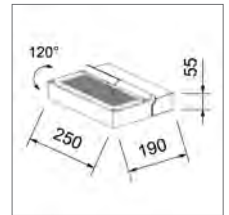

32 W

3000 lm

3000 K

CRI 80

Abstrahlwinkel: 29°

50'000h L70

1000 mA

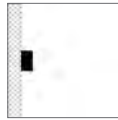

Variante



Art.-Nr.

26524-003-71

CHF

429.00



## Flood LED 10 W | Scheinwerfer

Klein und funktional



10 W  
1000 lm  
3000 K  
CRI 80  
Abstrahlwinkel: 100°  
40'000h L70

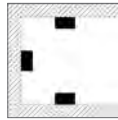

### Informationen

- flach und kompakt
- PIR-Sensor zum Anschrauben als Zubehör
- Leuchte aus Aluminium
- mit Anschlusskabel (0,5 m / 3 x 1,0 mm<sup>2</sup>)
- Farbe: schwarz, ~RAL 9004

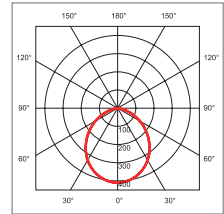
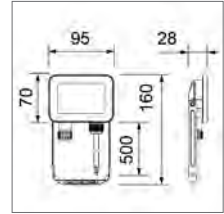

### Variante



Art.-Nr.

CHF

180-011-70

54.00

### Zubehör

Art.-Nr.

CHF

PIR-Sensor

180-011-00

34.00

Erdspiess, Aluminium

290-100-00

13.90

Kabelverbinder, IP68, 3-polig

30285-001-00

19.90



**Flood LED 20 W | Scheinwerfer**

klein und funktional



20 W

2000 lm

3000 K

CRI 80

Abstrahlwinkel: 100°

40'000h L70

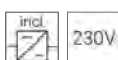
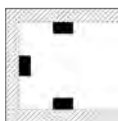
**Informationen**

- flach und kompakt
- PIR-Sensor zum Anschrauben als Zubehör
- Leuchte aus Aluminium
- mit Anschlusskabel (0.5 m / 3 x 1.0 mm<sup>2</sup>)
- Farbe: schwarz, ~RAL 9004

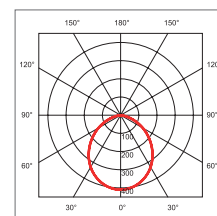
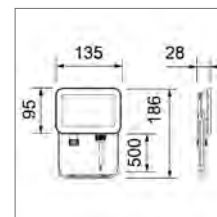
**Variante**

Art.-Nr.

CHF

180-021-70

64.00

**Zubehör**

Art.-Nr.

CHF

PIR-Sensor

180-011-00

34.00

Erdspiess, Aluminium

290-100-00

13.90

Kabelverbinder, IP68, 3-polig

30285-001-00

19.90

**Flood LED 30 W | Scheinwerfer**

klein und funktional



30 W

3000 lm

3000 K

CRI 80

Abstrahlwinkel: 100°

40'000h L70

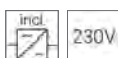
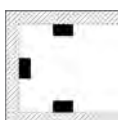
**Informationen**

- flach und kompakt
- PIR-Sensor zum Anschrauben als Zubehör
- Leuchte aus Aluminium
- mit Anschlusskabel (0.5 m / 3 x 1.0 mm<sup>2</sup>)
- Farbe: schwarz, ~RAL 9004

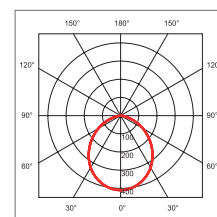
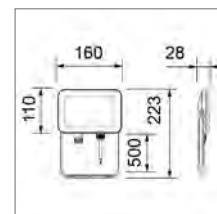
**Variante**

Art.-Nr.

CHF

180-031-70

74.00

**Zubehör**

Art.-Nr.

CHF

PIR-Sensor

180-011-00

34.00

Erdspiess, Aluminium

290-100-00

13.90

Kabelverbinder, IP68, 3-polig

30285-001-00

19.90



## Mastro LED 50 W | Scheinwerfer

kraftvolle Asymmetrie



50 W  
6500 lm  
4000 K  
CRI 80  
50'000h L70

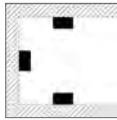

### Informationen

- asymmetrische Lichtverteilung (135° x 70°)
- gute Entblendung
- flache Bauform
- Top-Komponenten
- Leuchte aus Aluminium
- Farbe: silbergrau, ~RAL 9006
- Finish: pulverbeschichtet

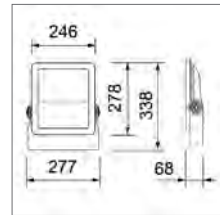

Variante	Anschlusskabel	Art.-Nr.	CHF
	2 m / 3 x 1.0 mm <sup>2</sup>	180-230-40	299.00
<b>NEW</b>	2 m / 5 x 1.0 mm <sup>2</sup>	180-255-40	• 549.00

Zubehör	Art.-Nr.	CHF
Kabelverbinder, IP68, 3-polig (nur für )	30285-001-00	19.90



**Mastro LED 100 W | Scheinwerfer**

kraftvolle Asymmetrie

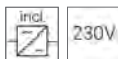
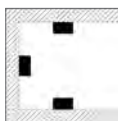

100 W  
12800 lm  
4000 K  
CRI 80  
50'000h L70

**Informationen**

- asymmetrische Lichtverteilung (135° x 70°)
- gute Entblendung
- flache Bauform
- Top-Komponenten
- Leuchte aus Aluminium
- Farbe: silbergrau, ~RAL 9006
- Finish: pulverbeschichtet

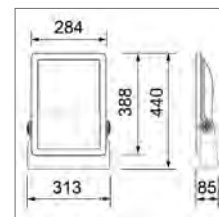

Variante	Anschlusskabel	Art.-Nr.	CHF
NEW	2 m / 3 x 1.0 mm <sup>2</sup>	180-231-40	449.00
	2 m / 5 x 1.0 mm <sup>2</sup>	180-256-40	• 699.00

Zubehör	Art.-Nr.	CHF
Kabelverbinder, IP68, 3-polig (nur für )	30285-001-00	19.90

**Mastro LED 150 W | Scheinwerfer**

kraftvolle Asymmetrie

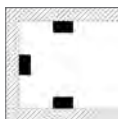

150 W  
19200 lm  
4000 K  
CRI 80  
50'000h L70

**Informationen**

- asymmetrische Lichtverteilung (135° x 70°)
- gute Entblendung
- flache Bauform
- Top-Komponenten
- Leuchte aus Aluminium
- mit Anschlusskabel (2 m / 3 x 1.0 mm<sup>2</sup>)
- Farbe: silbergrau, ~RAL 9006
- Finish: pulverbeschichtet

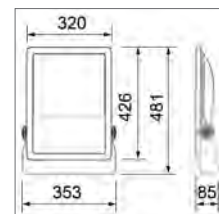

Variante	Anschlusskabel	Art.-Nr.	CHF
NEW	2 m / 3 x 1.0 mm <sup>2</sup>	180-232-40	599.00
	2 m / 5 x 1.0 mm <sup>2</sup>	180-257-40	• 799.00

Zubehör	Art.-Nr.	CHF
Kabelverbinder, IP68, 3-polig (nur für )	30285-001-00	19.90





Bodeneinbauleuchte  
**Via LED**







## Via LED | Bodeneinbauleuchte

dezent gezielt



1.2 W
80 lm
3000 K
CRI 80
Abstrahlwinkel: 60°
50'000h L70
350 mA
U <sub>F</sub> 3 – 4 V



### Informationen

- Leuchte aus Aluminium
- inkl. Einbaugehäuse
- mit Anschlusskabel (4.9 m / 2 x 0.75 mm<sup>2</sup>)
- Lochausschnitt bei Verwendung ohne Einbaugehäuse: 35 mm

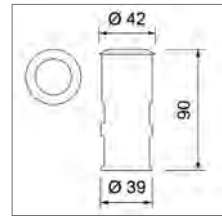

Farbtemperatur	Art.-Nr.	CHF
3000 K	180-208-70	84.00

Empfohlene Treiber	Seite	Art.-Nr.	CHF
4 W, 350 mA, IP68	397	27440-350-05	42.00

Zubehör	Art.-Nr.	CHF
Kabelverbinder, IP68, 3-polig	30285-001-00	19.90
Verteilerbox, IP68, 3-polig	30285-000-00	29.90

## Via One LED | Bodeneinbauleuchte

1-seitiger Lichtaustritt



1.2 W
5 lm
3000 K
CRI 80
Abstrahlwinkel: 60°
50'000h L70
350 mA
U <sub>F</sub> 3 – 4 V



### Informationen

- Leuchte aus Aluminium/Edelstahl
- inkl. Einbaugehäuse
- mit Anschlusskabel (4.9 m / 2 x 0.75 mm<sup>2</sup>)
- Lochausschnitt bei Verwendung ohne Einbaugehäuse: 35 mm

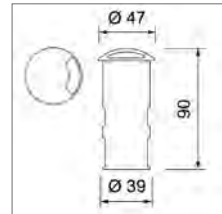

Farbtemperatur	Art.-Nr.	CHF
3000 K	180-205-71	104.00

Empfohlene Treiber	Seite	Art.-Nr.	CHF
4 W, 350 mA, IP68	397	27440-350-05	42.00

Zubehör	Art.-Nr.	CHF
Kabelverbinder, IP68, 3-polig	30285-001-00	19.90
Verteilerbox, IP68, 3-polig	30285-000-00	29.90

## Via Two LED | Bodeneinbauleuchte

2-seitiger Lichtaustritt



1.2 W  
10 lm  
3000 K  
CRI 80  
Abstrahlwinkel: 60°  
50'000h L70  
350 mA  
U<sub>F</sub> 3 – 4 V



### Informationen

- Leuchte aus Aluminium/Edelstahl
- inkl. Einbaugehäuse
- mit Anschlusskabel (4.9 m / 2 x 0.75 mm<sup>2</sup>)
- Lochausschnitt bei Verwendung ohne Einbaugehäuse: 35 mm

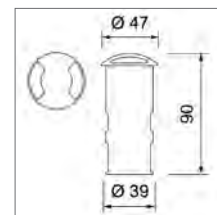

Farbtemperatur	Art.-Nr.	CHF
3000 K	180-206-71	104.00

Empfohlene Treiber	Seite	Art.-Nr.	CHF
⏻ 4 W, 350 mA, IP68	397	27440-350-05	42.00

Zubehör	Art.-Nr.	CHF
Kabelverbinder, IP68, 3-polig	30285-001-00	19.90
Verteilerbox, IP68, 3-polig	30285-000-00	29.90

## Via Three LED | Bodeneinbauleuchte

3-seitiger Lichtaustritt



1.2 W  
15 lm  
3000 K  
CRI 80  
Abstrahlwinkel: 60°  
50'000h L70  
350 mA  
U<sub>F</sub> 3 – 4 V



### Informationen

- Leuchte aus Aluminium/Edelstahl
- inkl. Einbaugehäuse
- mit Anschlusskabel (4.9 m / 2 x 0.75 mm<sup>2</sup>)
- Lochausschnitt bei Verwendung ohne Einbaugehäuse: 35 mm

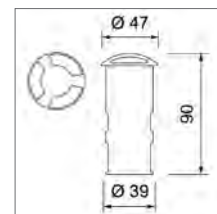

Farbtemperatur	Art.-Nr.	CHF
3000 K	180-207-71	104.00

Empfohlene Treiber	Seite	Art.-Nr.	CHF
⏻ 4 W, 350 mA, IP68	397	27440-350-05	42.00

Zubehör	Art.-Nr.	CHF
Kabelverbinder, IP68, 3-polig	30285-001-00	19.90
Verteilerbox, IP68, 3-polig	30285-000-00	29.90



## Mini LED | Bodeneinbauleuchte



3 W
300 lm
3000 K
CRI 80
Abstrahlwinkel: 15°
50'000h L70
350 mA
U <sub>e</sub> 9 V

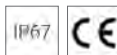

### Informationen

- Leuchte aus Aluminium/Edelstahl
- mit Anschlusskabel (3 m / 2 x 0.75 mm<sup>2</sup>)
- dimmbar DALI oder 1-10V auf Anfrage

passend zu  
Erdspiegleuchte Mini LED, S. 369

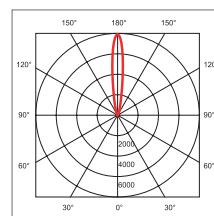
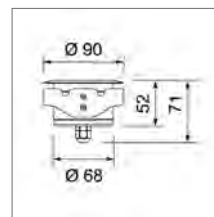

Farbtemperatur	Art.-Nr.	CHF
3000 K	660-111-70	219.00

Empfohlene Treiber	Seite	Art.-Nr.	CHF
⏻ 4 W, 350 mA, IP68	397	27440-350-05	42.00

Zubehör	Art.-Nr.	CHF
Kabelverbinder, IP68, 3-polig	30285-001-00	19.90

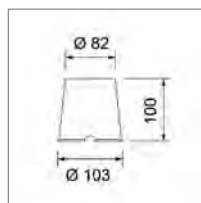

### Einbaugehäuse

Kunststoff

Variante	Art.-Nr.	CHF
	660-011-99	20.90

**L12 | Bodeneinbauleuchte**

Klein, flach, gut

**CRI  
90****Informationen**

- geringe Einbautiefe
- hochwertige Materialien
- Leuchte aus Aluminium/Edelstahl
- mit Anschlusskabel (4.9 m / 2 x 0.75 mm<sup>2</sup>)
- Der LED-Treiber 043-700-04 muss in ein IP geschütztes Einbaugehäuse oder einen geschützten Schaltschrank platziert werden

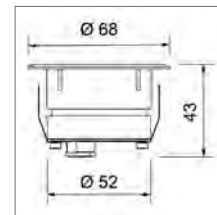

3 W

130 lm, 140 lm

3000 K

CRI 90

Abstrahlwinkel: 8°, 36°

50'000h L80

700 mA

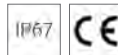
U<sub>F</sub> 3 V

Abstrahlwinkel	Art.-Nr.	CHF
8°	180-216-70	164.00
36°	180-217-70	164.00

Empfohlene Treiber	Seite	Art.-Nr.	CHF
4 W, 700 mA, IP68	397	27440-700-05	42.00
4 W, 700 mA, IP65	397	043-700-04	30.00

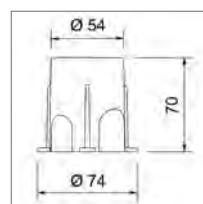
**Einbetoniergehäuse**

Kunststoff

Variante	Art.-Nr.	CHF
	180-216-99	29.00

**L10 Round | Bodeneinbauleuchte**

robust, zuverlässig, schnell montiert

**NEW**

4.5 W  
250 lm  
3000 K  
CRI 80  
Abstrahlwinkel: 24°  
50'000h L80  
200 mA

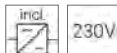
**Informationen**

- 30° schwenkbar (2 x 15°)
- einfache und sichere Montage mit vorkonfektionierter Anschlussbox für Durchgangsverdrahtung
- Silikondichtungen
- Leuchte aus Aluminium/Edelstahl
- Lochausschnitt bei Verwendung ohne Einbetoniergehäuse: 75 mm

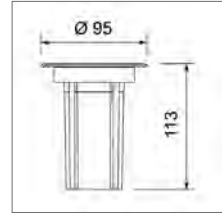

Variante	Art.-Nr.	CHF
	180-210-71	234.00

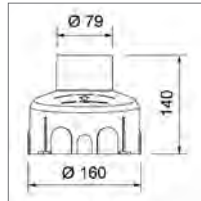
**Einbetoniergehäuse**

Kunststoff

Variante	Art.-Nr.	CHF
	180-210-99	59.00

**L11 Round | Bodeneinbauleuchte**

robust, zuverlässig, schnell montiert

**NEW**

6.3 W  
450 lm  
3000 K  
CRI 80  
Abstrahlwinkel: 24°  
50'000h L80  
150 mA

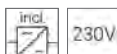
**Informationen**

- 30° kardanisch schwenkbar
- einfache und sichere Montage mit vorkonfektionierter Anschlussbox für Durchgangsverdrahtung
- Silikondichtungen
- Leuchte aus Aluminium/Edelstahl
- Lochausschnitt bei Verwendung ohne Einbetoniergehäuse: 100 mm

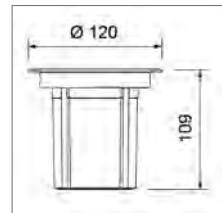

Variante	Art.-Nr.	CHF
	180-212-71	249.00

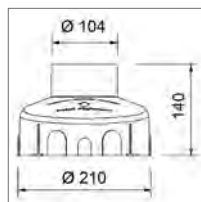
**Einbetoniergehäuse**

Kunststoff

Variante	Art.-Nr.	CHF
	180-212-99	69.00

**L10 Square | Bodeneinbauleuchte**

robust, zuverlässig, schnell montiert

NEW



4.5 W  
250 lm  
3000 K  
CRI 80  
Abstrahlwinkel: 24°  
50'000h L80  
200 mA

**Informationen**

- 30° schwenkbar (2 x 15°)
- einfache und sichere Montage mit vorkonfektionierter Anschlussbox für Durchgangsverdrahtung
- Silikondichtungen
- Leuchte aus Aluminium/Edelstahl
- Lochausschnitt bei Verwendung ohne Einbetoniergehäuse: 75 mm

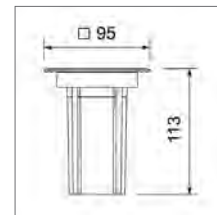
**Variante**

Art.-Nr.

180-211-71

CHF

234.00

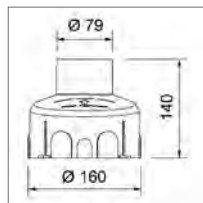
**Einbetoniergehäuse**

Kunststoff

**Variante**

Art.-Nr.

180-210-99

CHF

59.00

**L11 Square | Bodeneinbauleuchte**

robust, zuverlässig, schnell montiert

NEW



6.3 W  
450 lm  
3000 K  
CRI 80  
Abstrahlwinkel: 24°  
50'000h L80  
150 mA

**Informationen**

- 30° kardanisch schwenkbar
- einfache und sichere Montage mit vorkonfektionierter Anschlussbox für Durchgangsverdrahtung
- Silikondichtungen
- Leuchte aus Aluminium/Edelstahl
- Lochausschnitt bei Verwendung ohne Einbetoniergehäuse: 100 mm

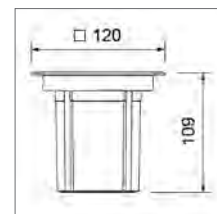
**Variante**

Art.-Nr.

180-213-71

CHF

249.00

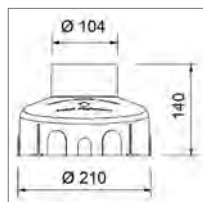
**Einbetoniergehäuse**

Kunststoff

**Variante**

Art.-Nr.

180-212-99

CHF

69.00



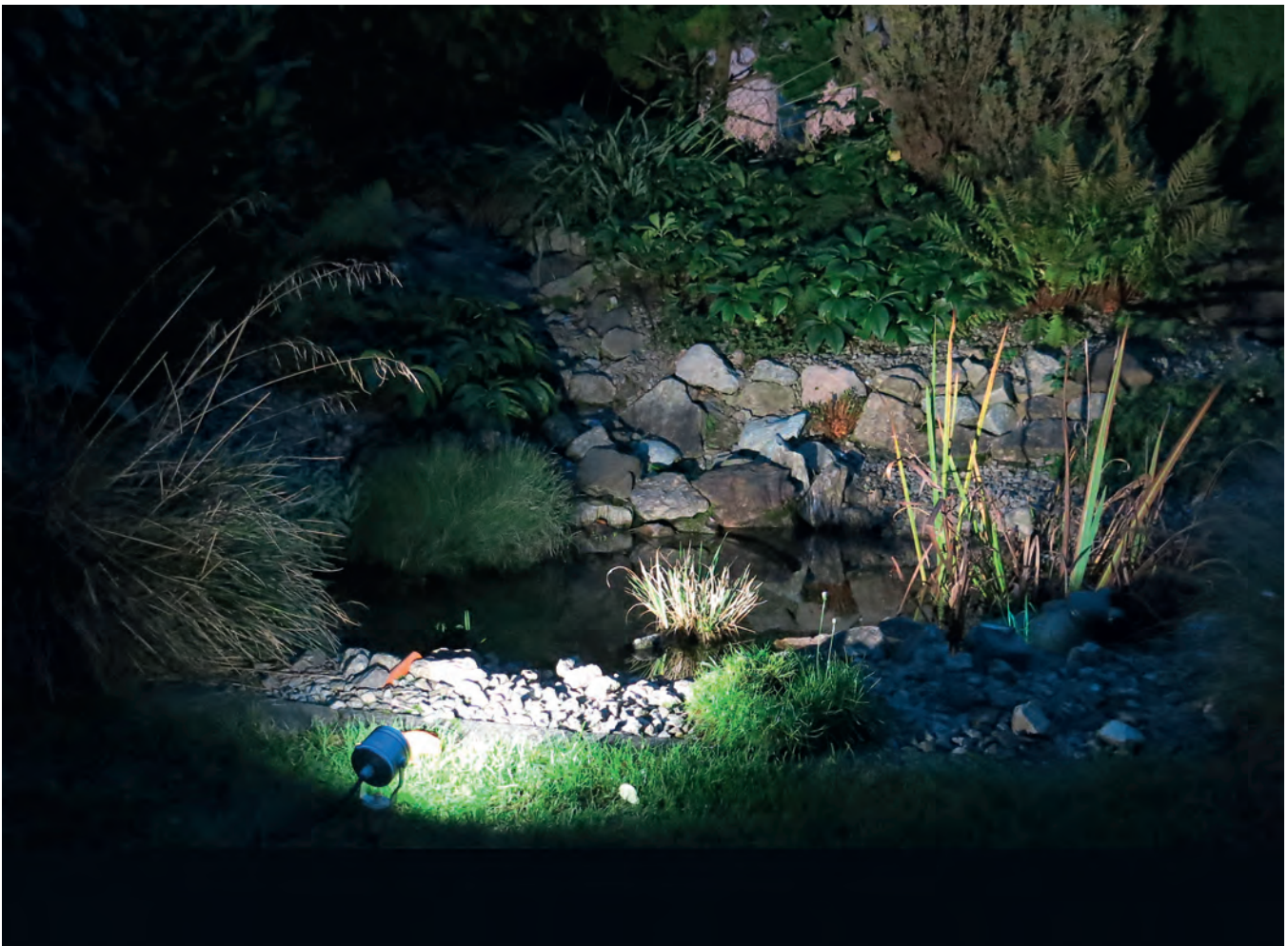

**Nano LED | Erdspiessleuchte**

klein und edel

CRI  
90

NEW



1.5 W

120 lm

3000 K

CRI 90

Abstrahlwinkel: 24°

50'000h L70

500 mA

U<sub>F</sub> 2 – 5 V**Informationen**

- Leuchte aus Aluminium
- 130° schwenkbar
- inkl. Erdspiess
- mit Anschlusskabel (3 m / 2 x 0.75 mm<sup>2</sup>)
- Der LED-Treiber muss in ein IP geschütztes Einbaugeschütz oder einen geschützten Schaltschrank platziert werden

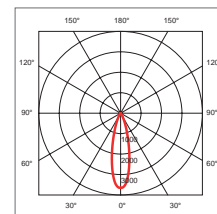
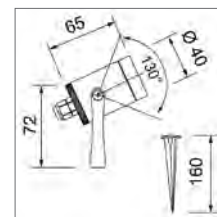
**Farbtemperatur**

3000 K

**Art.-Nr.**

180-203-71

**CHF**

144.00

**Empfohlene Treiber**

4 W, 500 mA, IP65

**Seite**

397

**Art.-Nr.**

043-500-04

**CHF**

30.00

**Zubehör**

Kabelverbinder, IP68, 3-polig

**Art.-Nr.**

30285-001-00

**CHF**

19.90

**Mini LED | Erdspiessleuchte**

edel in Material



3 W

300 lm

3000 K

CRI 80

Abstrahlwinkel: 40°

50'000h L70

350 mA

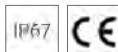
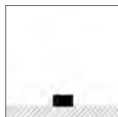
U<sub>F</sub> 9 V**Informationen**

- Leuchte aus Aluminium
- 130° schwenkbar
- inkl. Erdspiess
- mit Anschlusskabel (3 m / 2 x 0.75 mm<sup>2</sup>)

passend zu

Bodeneinbauleuchte Mini LED, S. 364

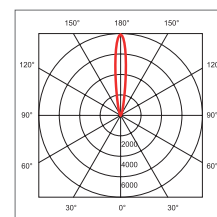
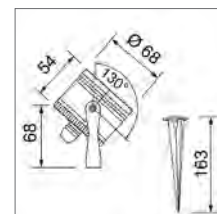
**Farbtemperatur**

3000 K

**Art.-Nr.**

660-113-70

**CHF**

199.00

**Empfohlene Treiber**

4 W, 350 mA, IP68

**Seite**

397

**Art.-Nr.**

27440-350-05

**CHF**

42.00

**Zubehör**

Kabelverbinder, IP68, 3-polig

**Art.-Nr.**

30285-001-00

**CHF**

19.90

**Ersatzteil**

Erdspiess, Aluminium

**Art.-Nr.**

290-100-00

**CHF**

13.90



## Spike II Mini | Erdspiessleuchte

das Lichtwerkzeug im Garten

NEW



### Informationen

- Leuchte aus Aluminium
- 135° schwenkbar
- inkl. Erdspieß
- mit Anschlusskabel (4.9 m / 3 x 1.0 mm<sup>2</sup>)
- Farbe: anthrazit, ~RAL 7016
- Finish: pulverbeschichtet

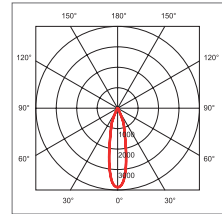
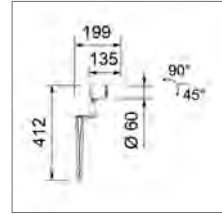

3.5 W  
380 lm  
3000 K  
CRI 80  
Abstrahlwinkel: 24°  
50'000h L70  
200 mA

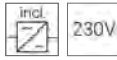

Variante	Art.-Nr.	CHF
	180-200-72	209.00

Optional	Art.-Nr.	CHF
Stecker, Typ 13, schwarz, IP55	290-111-00	• 31.00

Ersatzteil	Art.-Nr.	CHF
Erdspieß	180-200-99	19.00



## Spike II Medium | Erdspiessleuchte

das Lichtwerkzeug im Garten

NEW



9.1 W  
800 lm  
3000 K  
CRI 80  
Abstrahlwinkel: 36°  
50'000h L70  
500 mA

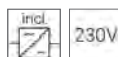
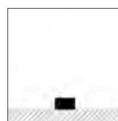

### Informationen

- Leuchte aus Aluminium
- 135° schwenkbar
- inkl. Erdspiess
- mit Anschlusskabel (4.9 m / 3 x 1.0 mm<sup>2</sup>)
- Farbe: anthrazit, ~RAL 7016
- Finish: pulverbeschichtet

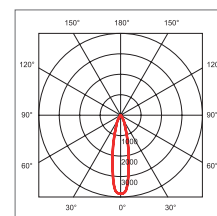
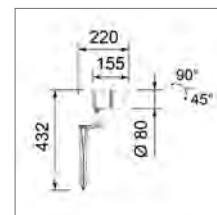

### Variante



Art.-Nr.

CHF

180-201-72

269.00

### Optional

Stecker, Typ 13, schwarz, IP55

Art.-Nr.

CHF

290-111-00

• 31.00

### Ersatzteil

Erdspiess

Art.-Nr.

CHF

180-200-99

19.00

## Spike II Maxi | Erdspiessleuchte

das Lichtwerkzeug im Garten

NEW



16.3 W  
1300 lm  
3000 K  
CRI 80  
Abstrahlwinkel: 30°  
50'000h L70  
350 mA

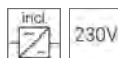
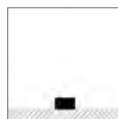

### Informationen

- Leuchte aus Aluminium
- 135° schwenkbar
- inkl. Erdspiess
- mit Anschlusskabel (4.9 m / 3 x 1.0 mm<sup>2</sup>)
- Farbe: anthrazit, ~RAL 7016
- Finish: pulverbeschichtet

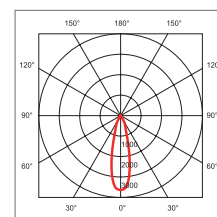
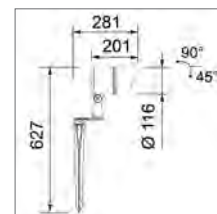

### Variante



Art.-Nr.

CHF

180-202-72

399.00

### Optional

Stecker, Typ 13, schwarz, IP55

Art.-Nr.

CHF

290-111-00

• 31.00

### Ersatzteil

Erdspiess

Art.-Nr.

CHF

180-202-99

44.00







## Spike II Medium | Aufbauleuchte



### Informationen

- Leuchte aus Aluminium
- 135° schwenkbar
- 355° drehbar
- inkl. Aufbaurosette
- Aussparung für Aufputz-Einspeisung
- Serienvorkabelung möglich
- Farbe: anthrazit, ~RAL 7016
- Finish: pulverbeschichtet

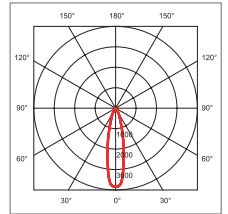
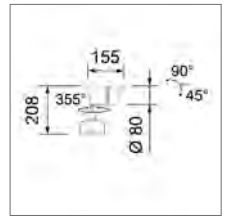

9.1 W

800 lm

3000 K

CRI 80

Abstrahlwinkel: 36°

50'000h L70

500 mA

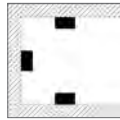

Variante



Art.-Nr.

180-209-71

CHF

269.00

## Tom Round II LED 1100 mm | Pollerleuchte

Lichtfarbe wählbar, dimmbar, rasch montiert



11.5 W  
270 lm / 300 lm  
3000/2700 K switchable  
CRI 80  
Abstrahlwinkel: 360°  
50'000h L70  
500 mA

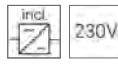

### Informationen

- rotationssymmetrischer Lichtaustritt
- von 3000 auf 2700 Kelvin umschaltbar
- hochwertige Materialien
- Leuchte aus Aluminium
- Farbe: anthrazit, ~RAL 7016
- Finish: pulverbeschichtet

passend zu  
Wandaufbauleuchte Tom Round II LED, S. 347

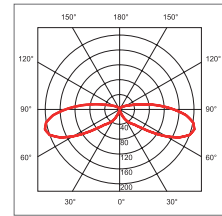
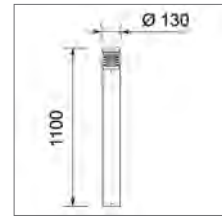

Variante	Art.-Nr.	CHF
 RC	180-306-70	• 499.00

Zubehör	Art.-Nr.	CHF
Abdeckung	180-305-95	31.00
Bodenflansch	180-305-97	52.00
Kabelverbinder, IP68, 3-polig	30285-001-00	19.90
Verteilerbox, IP68, 3-polig	30285-000-00	29.90

## Tom Round II LED 800 mm | Pollerleuchte

Lichtfarbe wählbar, dimmbar, rasch montiert



11.5 W  
270 lm / 300 lm  
3000/2700 K switchable  
CRI 80  
Abstrahlwinkel: 360°  
50'000h L70  
500 mA

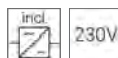

### Informationen

- rotationssymmetrischer Lichtaustritt
- von 3000 auf 2700 Kelvin umschaltbar
- hochwertige Materialien
- Leuchte aus Aluminium
- Farbe: anthrazit, ~RAL 7016
- Finish: pulverbeschichtet

passend zu  
Wandaufbauleuchte Tom Round II LED, S. 347

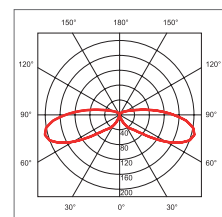
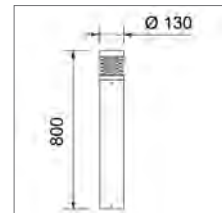

Variante	Art.-Nr.	CHF
 RC	180-300-70	399.00

Zubehör	Art.-Nr.	CHF
Abdeckung	180-305-95	31.00
Bodenflansch	180-305-97	52.00
Kabelverbinder, IP68, 3-polig	30285-001-00	19.90
Verteilerbox, IP68, 3-polig	30285-000-00	29.90

## Tom Round II LED 265 mm | Pollerleuchte

Lichtfarbe wählbar, dimmbar, rasch montiert



11.5 W
270 lm / 300 lm
3000/2700 K switchable
CRI 80
Abstrahlwinkel: 360°
50'000h L70
500 mA



### Informationen

- rotationssymmetrischer Lichtaustritt
- von 3000 auf 2700 Kelvin umschaltbar
- hochwertige Materialien
- Leuchte aus Aluminium
- nicht für Montage in Erdreich geeignet
- Farbe: anthrazit, ~RAL 7016
- Finish: pulverbeschichtet

passend zu  
Wandaufbauleuchte Tom Round II LED, S. 347

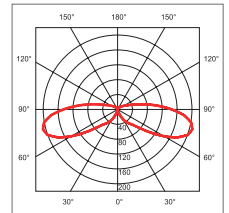
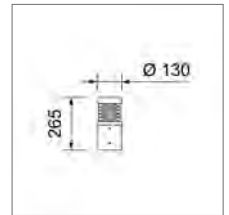

Variante	Art.-Nr.	CHF
 R.C.	180-301-70	349.00

Zubehör	Art.-Nr.	CHF
Abdeckung	180-305-95	31.00
Bodenflansch	180-305-97	52.00
Kabelverbinder, IP68, 3-polig	30285-001-00	19.90
Verteilerbox, IP68, 3-polig	30285-000-00	29.90





## Tom Square II LED 1100 mm | Pollerleuchte

Lichtfarbe wählbar, dimmbar, rasch montiert



11.5 W  
270 lm / 300 lm  
3000/2700 K switchable  
CRI 80  
Abstrahlwinkel: 360°  
50'000h L70  
500 mA

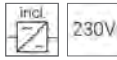

### Informationen

- rotationssymmetrischer Lichtaustritt
- von 3000 auf 2700 Kelvin umschaltbar
- hochwertige Materialien
- Leuchte aus Aluminium
- Farbe: anthrazit, ~RAL 7016
- Finish: pulverbeschichtet

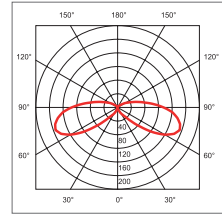
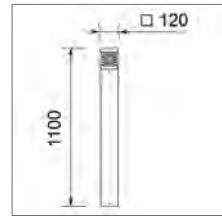

### Variante



Art.-Nr. CHF

180-307-70 • 499.00

### Optional

Bohrung, 68 mm, für Sensor

Art.-Nr. CHF

Z-BOHRUNG-SPEZ • 69.00

### Zubehör

Abdeckung

Art.-Nr. CHF

180-305-96 20.00

Bodenflansch

180-305-98 52.00

Kabelverbinder, IP68, 3-polig

30285-001-00 19.90

Verteilerbox, IP68, 3-polig

30285-000-00 29.90

## Tom Square II LED 800 mm | Pollerleuchte

Lichtfarbe wählbar, dimmbar, rasch montiert



11.5 W  
270 lm / 300 lm  
3000/2700 K switchable  
CRI 80  
Abstrahlwinkel: 360°  
50'000h L70  
500 mA

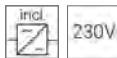

### Informationen

- rotationssymmetrischer Lichtaustritt
- von 3000 auf 2700 Kelvin umschaltbar
- hochwertige Materialien
- Leuchte aus Aluminium
- Farbe: anthrazit, ~RAL 7016
- Finish: pulverbeschichtet

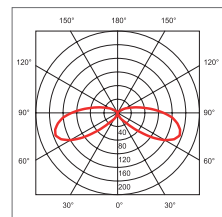
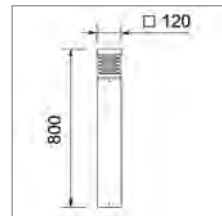

### Variante



Art.-Nr. CHF

180-303-70 399.00

### Optional

Bohrung, 68 mm, für Sensor

Art.-Nr. CHF

Z-BOHRUNG-SPEZ • 69.00

### Zubehör

Abdeckung

Art.-Nr. CHF

180-305-96 20.00

Bodenflansch

180-305-98 52.00

Kabelverbinder, IP68, 3-polig

30285-001-00 19.90

Verteilerbox, IP68, 3-polig

30285-000-00 29.90

## Tom Square II LED 265 mm | Pollerleuchte

Lichtfarbe wählbar, dimmbar, rasch montiert



11.5 W

270 lm / 300 lm

3000/2700 K switchable

CRI 80

Abstrahlwinkel: 360°

50'000h L70

500 mA



### Informationen

- rotationssymmetrischer Lichtaustritt
- von 3000 auf 2700 Kelvin umschaltbar
- hochwertige Materialien
- Leuchte aus Aluminium
- nicht für Montage in Erdreich geeignet
- Farbe: anthrazit, ~RAL 7016
- Finish: pulverbeschichtet

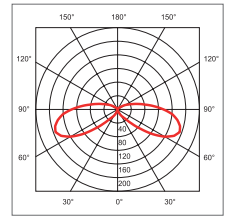
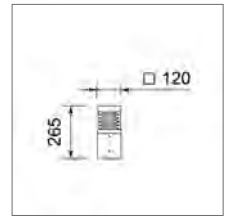

### Variante



Art.-Nr.

CHF

180-304-70

349.00

### Zubehör

Art.-Nr.

CHF

Abdeckung

180-305-96 20.00

Bodenflansch

180-305-98 52.00

Kabelverbinder, IP68, 3-polig

30285-001-00 19.90

Verteilerbox, IP68, 3-polig

30285-000-00 29.90







**Lim LED | Pollerleuchte**

Die schlanke, dauerhafte Schönheit

**CRI  
90**

9 W  
380 lm, 420 lm  
3000/2700 K switchable  
CRI 90  
Abstrahlwinkel: 120°  
40'000h L70

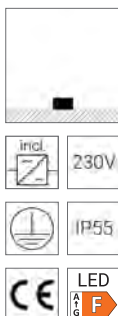
**Informationen**

- dekorativer Lichteffect
- von 3000 auf 2700 Kelvin umschaltbar
- Leuchte aus Aluminium
- inkl. Montagesockel
- inkl. Verteilerbox (rund, IP66)
- Farbe: anthrazit, ~RAL 7024
- Finish: pulverbeschichtet

passend zu Wandaufbauleuchte  
Lim, S. 261 / Lim Outdoor, S. 379

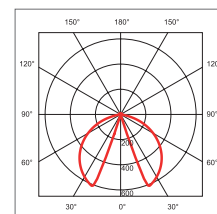
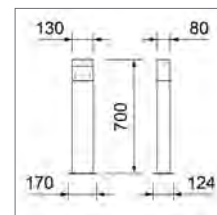

Variante	Art.-Nr.	CHF
 RC	116-039-72	439.00

Optional	Art.-Nr.	CHF
Bohrung, 68 mm, für Sensor oder Steckdose	Z-BOHRUNG-SPEZ	• 69.00

Zubehör	Art.-Nr.	CHF
Abdeckung, für 1-seitigen Lichtaustritt	116-042-52	31.00

**Square LED | Pollerleuchte**

Klar in Design und Licht

**NEW**

8 W  
650 lm  
3000 K  
CRI 80  
Abstrahlwinkel: 24°  
50'000h L70  
350 mA

**Informationen**

- gute Lichtausbeute
- Leuchte aus Aluminium
- Farbe: anthrazit, ~RAL 7016
- Finish: pulverbeschichtet

passend zu  
Wandaufbauleuchte Square LED, S. 351

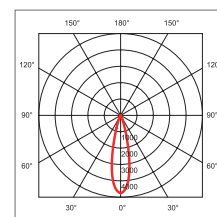
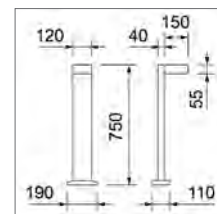

Variante	Art.-Nr.	CHF
	26524-007-71	289.00

Zubehör	Art.-Nr.	CHF
Verteilerbox, IP68, 3-polig	30285-000-00	29.90



## Konstantspannungs- Treiber

### Parallelschaltung

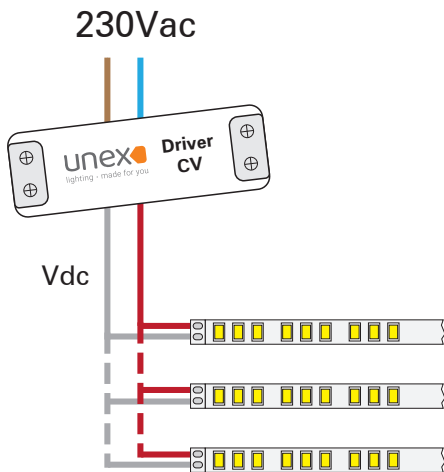

Die Leistung definiert wie viele Leuchten maximal an einen Treiber angeschlossen werden können.

Bitte beachten Sie, es ist manchmal eine Minimal-Leistung erforderlich um einen sicheren Betrieb zu garantieren.

## Konstantstrom- Treiber

### Reihenschaltung

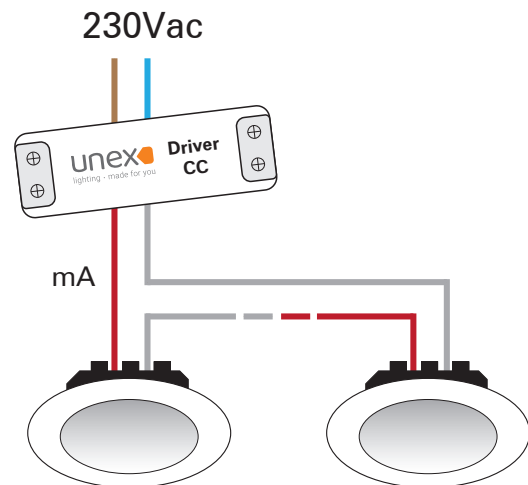

Die Vorwärtsspannung in Volt definiert wie viele Leuchten an einen Treiber angeschlossen werden können.

Bitte beachten Sie, es ist manchmal eine Minimal-Vorwärtsspannung erforderlich um einen sicheren Betrieb zu garantieren.

## Dimmen mit Phasenabschnitt

Warum wir Phasenabschnitt verwenden?

### Die Vorteile liegen auf der Hand:

- Geeignet für LED
- Geeignet für kapazitive Last
- Stufenloses Dimming
- Weniger elektromagnetische Störungen
- Sehr tiefe Minimal-Helligkeit einstellbar

### Alle unsere Phasenabschnitt-Treiber lassen sich auf drei Arten steuern:

- mit dem Bluetooth-Steuermodul  
damit lassen sich Leuchten per Taster bzw. Bluetooth dimmen (App)
- mit dem Zigbee-Steuermodul  
damit lassen sich Leuchten per Taster dimmen oder in ein bestehendes Smart Home System integrieren (Google Assistant, Amazon Alex und Philips Hue)
- mit dem Unex Drehregler oder Feller Universaldimmer

Auch bei hochwertigsten Konvertern mit netzseitiger Phasenabschnittsdimmung können Störungen durch Netzsignale usw. nicht restlos ausgeschlossen werden.

## Dimmen mit DALI

Für jede Anwendung die richtige Lösung

### Alle unsere DALI-Treiber lassen sich auf drei Arten steuern:

- mit einem Taster (PushDim-Funktionalität)
- über den Anschluss an ein Gebäudeautomationssystem, welches viele Programmierungsmöglichkeiten eröffnet
- mit dem Unex DALI Drehregler oder Feller DALI Power Drehgeber

Neu finden Sie auch DALI DT8 Komponenten in unserem Sortiment – für eine optimale Steuerung von Farben, RGB(W) oder Tunable White. Falls nicht anders spezifiziert, sind unsere Komponenten DALI DT6.

### Installations-/Kombinationsbeispiele

für jede Lösung sind Konstantstrom- und Konstantspannungs-Treiber kombinierbar

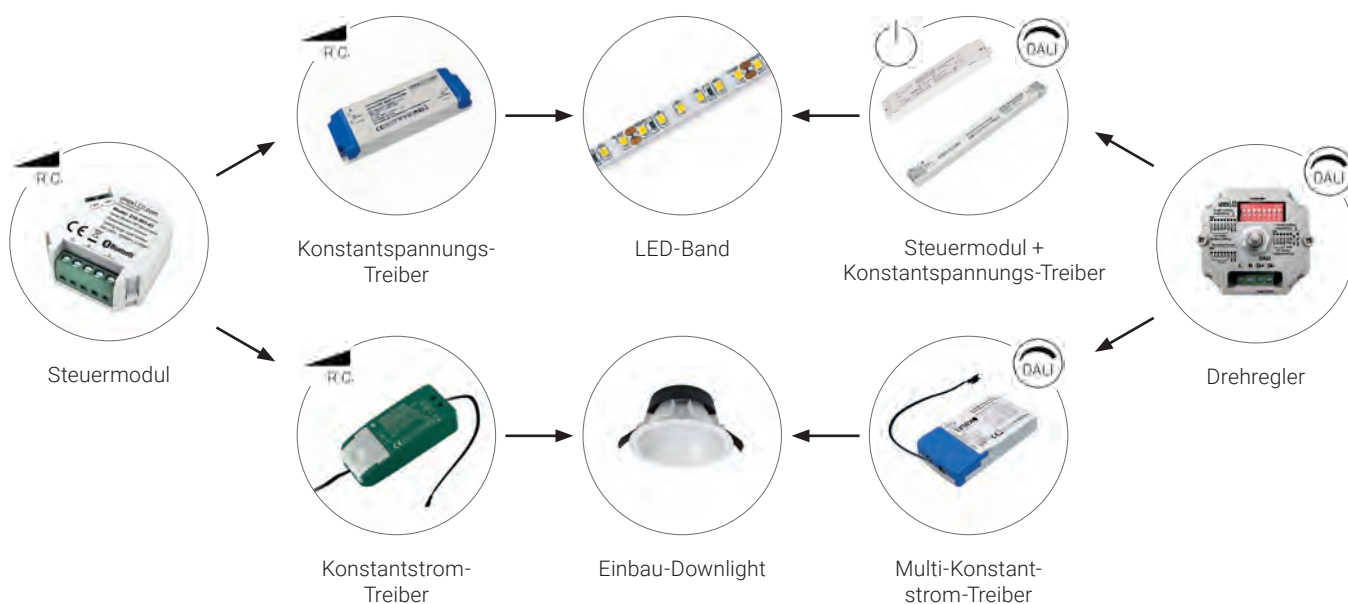

## Steckernetzgerät



24 V / 20 W  
S. 386

## Tischnetzgerät



24 V / 20 W  
S. 386

## Konstantspannungs-Treiber



24 V / 20 W  
S. 387



24 V / 20 W  
S. 387



24 V / 30 W  
S. 387



24 V / 30 W  
S. 388



24 V / 30 W  
S. 388



24 V / 75 W  
S. 389



24 V / 100 W  
S. 389



24 V / 150 W  
S. 389



24 V / 12 W  
S. 390



24 V / 40 W  
S. 390



24 V / 60 W  
S. 390



24 V / 90 W  
S. 391



24 V / 120 W  
S. 391



24 V / 150 W  
S. 391



24 V / 240 W  
S. 392



24 V / 320 W  
S. 392



24 V / 480 W  
S. 392



24 V / 25 W  
S. 393



24 V / 50 W  
S. 393



24 V / 100 W  
S. 393



24 V / 200 W  
S. 394



24 V / 35 W  
S. 394



24 V / 50 W  
S. 394



24 V / 80 W  
S. 395



24 V / 160 W  
S. 395

### Konstantstrom-Treiber



350 mA / 3 W  
S. 396



350 mA / 20 W  
S. 396



500 mA / 20 W  
S. 396



700 mA / 20 W  
S. 396



700 mA / 40 W  
S. 396



900 mA / 40 W  
S. 396



350 mA / 4 W  
S. 397



700 mA / 4 W  
S. 397



500 mA / 4 W  
S. 397



700 mA / 4 W  
S. 397



260 mA / 9 W  
S. 398



350 mA / 9 W  
S. 398



260 mA / 12 W  
S. 398



350 mA / 12 W  
S. 398



500 mA / 12 W  
S. 399



350 mA / 18 W  
S. 399



500 mA / 22 W  
S. 399



700 mA / 22 W  
S. 400



700 mA / 40 W  
S. 400



900 mA / 40 W  
S. 400



1050 mA / 45 W  
S. 401

### Multi-Konstantstrom-Treiber



260/350 mA / 10 W  
S. 402



500/700 mA / 10 W  
S. 402



180 - 500 mA / 12 W  
S. 403



260 - 700 mA / 25 W  
S. 403



260 - 700 mA / 25 W  
S. 404



350 - 1050 mA / 45 W  
S. 404



250 - 1500 mA / 50 W  
S. 405



350 - 1050 mA / 60 W  
S. 406



350 - 1400 mA / 80 W  
S. 406



## Notlichtelement



EMLED DALI 2, lang  
S. 407

## Touch-Dimmer



Built-in PWM, 24 V  
S. 408

## Steuermodul



Funk 4-Kanal  
S. 408



DALI  
S. 409



DALI Tunable White  
S. 409



DALI RGB(W)  
S. 410



DALI IP67, 4-Kanal  
S. 410



Phasenabschnitt/  
DALI  
S. 411



Taster/Bluetooth  
S. 412



Taster/ZigBee  
S. 412



DALI/Zigbee  
S. 413



Casambi 4-Kanal  
S. 414



DALI/Casambi  
S. 414



DALI/Casambi  
S. 415

## Funktaster



1-farbig  
S. 416



1-farbig  
S. 416



Tunable White  
S. 417



RGB  
S. 417

## Fernbedienung



1-farbig  
S. 418



Tunable White  
S. 418



RGB(W)  
S. 418

## Wand-Controller



Tunable White  
S. 419



RGB(W)  
S. 419

## Wandtaster



Casambi  
S. 419

## Drehregler



Phasenabschnitt  
S. 420



DALI  
S. 420



DALI Tunable White  
S. 421



DALI RGB  
S. 421

## 24 W | Steckernetzgerät



24 W

PRI 230V	SEC 24V
-------------	------------

IP20
------

CE
----

### Informationen

- mit Stecker
- 24 W AC/DC Adapter
- PRI/AC: 2-poliger EU-Stecker
- SEC/DC: Rundstecker

Variante	Art.-Nr.	CHF
	PS-V24-W24-X2	37.00

## 60 W | Tischnetzgerät



60 W

PRI 230V	SEC 24V
-------------	------------

IP20
------

CE
----

### Informationen

- mit Stecker

Variante	Art.-Nr.	CHF
	MW-TNG-60-24	63.00



### Netz kabel

CH-Version

Variante	Art.-Nr.	CHF
	MW-AA-220-06-S	5.90



### Rundstecker

Variante	Art.-Nr.	CHF
	LS-P-1-1	9.50

## 20 W | Konstantspannungs-Treiber

mit Anschlussklemmen



20 W  
Flicker <30%  
L: 113 mm  
B: 44 mm  
H: 28 mm



Leistung	Art.-Nr.	CHF
20 W	043-024-020	42.00

## 20 W | Konstantspannungs-Treiber

mit Anschlussklemmen



20 W  
Flicker <30%  
L: 128 mm  
B: 50 mm  
H: 13 mm



### Informationen

- flache Bauform
- DC tauglich

Leistung	Art.-Nr.	CHF
20 W	043-024-021	45.00

## 30 W | Konstantspannungs-Treiber

mit Anschlussklemmen



30 W  
Flicker <30%  
L: 155 mm  
B: 53 mm  
H: 16 mm



### Informationen

- flache Bauform

Leistung	Art.-Nr.	CHF
30 W	043-024-031	56.00



## 30 W | Konstantspannungs-Treiber

NEW



30 W  
Flicker <30%  
L: 155 mm  
B: 53 mm  
H: 16 mm



## Informationen

- flache Bauform
- DC tauglich
- montagefreundliches Stecksystem
- mit Sekundär-Anschlusskabel (0.3 m) inkl. Stecker

Leistung	Art.-Nr.	CHF
30 W	043-024-034	57.00



## Netz Kabel

weiss, 230 V ac Einspeisung, mit Schalter und Netzstecker, 230 V, 2 x 0.75 mm<sup>2</sup>, max. 2.5 A

Länge	Art.-Nr.	CHF
1500 mm	23294-105-89	9.00



## Verteiler, 6-fach

weiss, mit 1 m Kabel, max. 3 A, 6 – 24 V dc

Variante	Art.-Nr.	CHF
	23294-105-99	6.00

## 30 W | Konstantspannungs-Treiber

mit Anschlussklemmen

NEW



30 W  
Flicker <5%  
L: 262 mm  
B: 30 mm  
H: 17 mm



## Informationen

- Befestigung mit mittig positionierten Schrauben ins Profil möglich
- schlanke Bauform
- passt in das Profil Modular
- DC tauglich
- kombinierbar mit Steuermodul

Leistung	Art.-Nr.	CHF
30 W	043-024-032	58.00

NEW

## 75 W | Konstantspannungs-Treiber

mit Anschlussklemmen



75 W  
Flicker <5%  
L: 316 mm  
B: 30 mm  
H: 17 mm



### Informationen

- Befestigung mit mittig positionierten Schrauben ins Profil möglich
- schlanke Bauform
- passt in das Profil Modular
- DC tauglich
- kombinierbar mit Steuermodul

Leistung	Art.-Nr.	CHF
75 W	043-024-076	79.00

## 100 W | Konstantspannungs-Treiber

mit Anschlussklemmen



100 W  
Flicker <5%  
L: 320 mm  
B: 30 mm  
H: 18.2 mm



### Informationen

- Befestigung mit mittig positionierten Schrauben ins Profil möglich
- schlanke Bauform
- passt in das Profil Modular
- DC tauglich
- kombinierbar mit Steuermodul

Leistung	Art.-Nr.	CHF
100 W	043-024-101	119.00

## 150 W | Konstantspannungs-Treiber

mit Anschlussklemmen



150 W  
Flicker <5%  
L: 335 mm  
B: 30 mm  
H: 22 mm



### Informationen

- schlanke Bauform
- passt in das Profil Modular
- DC tauglich
- kombinierbar mit Steuermodul

Leistung	Art.-Nr.	CHF
150 W	043-024-150	144.00

## 12 W | Konstantspannungs-Treiber



12 W  
L: 50 mm  
B: 48 mm  
H: 24 mm

**Informationen**

- mit Anschlusskabel PRI (0.2 m / 2 x 0.75 mm<sup>2</sup>)
- mit Anschlusskabel SEC (0.2 m / 2 x 1.0 mm<sup>2</sup>)
- kompakte Bauform
- passt in UP Dose E-No. 372 002 929
- max. Länge Anschlusskabel SEC: 5 m
- Treiber zum Einbauen

Leistung	Art.-Nr.	CHF
12 W	200-022-012	39.00

## 40 W | Konstantspannungs-Treiber



40 W  
1.67 A  
L: 150 mm  
B: 53 mm  
H: 35 mm

**Informationen**

- mit Anschlusskabel (0.3 m / 2 x 0.75 mm<sup>2</sup>)

Leistung	Art.-Nr.	CHF
40 W	200-001-040	67.00

## 60 W | Konstantspannungs-Treiber



60 W  
2.50 A  
L: 150 mm  
B: 53 mm  
H: 35 mm

**Informationen**

- mit Anschlusskabel (0.3 m / 2 x 0.75 mm<sup>2</sup>)

Leistung	Art.-Nr.	CHF
60 W	200-001-060	79.00

## 90 W | Konstantspannungs-Treiber



90 W  
3.75 A  
L: 171 mm  
B: 63 mm  
H: 37.5 mm



### Informationen

- mit Anschlusskabel PRI (0.3 m / 2 x 0.75 mm<sup>2</sup>)
- mit Anschlusskabel SEC (0.3 m / 2 x 1.5 mm<sup>2</sup>)

Leistung	Art.-Nr.	CHF
90 W	200-001-090	99.00

## 120 W | Konstantspannungs-Treiber



120 W  
5.00 A  
L: 191 mm  
B: 63 mm  
H: 37.5 mm



### Informationen

- mit Anschlusskabel PRI (0.3 m / 2 x 0.75 mm<sup>2</sup>)
- mit Anschlusskabel SEC (0.3 m / 2 x 2.5 mm<sup>2</sup>)

Leistung	Art.-Nr.	CHF
120 W	200-001-120	134.00

## 150 W | Konstantspannungs-Treiber



150 W  
6.30 A  
L: 219 mm  
B: 63 mm  
H: 35.5 mm



### Informationen

- Spannung und Strombegrenzung auf der Rückseite einstellbar
- mit Anschlusskabel PRI (0.3 m / 3 x 1.0 mm<sup>2</sup>)
- mit Anschlusskabel SEC (0.3 m / 2 x 1.0 mm<sup>2</sup>)

Leistung	Art.-Nr.	CHF
150 W	200-002-150	144.00



## 240 W | Konstantspannungs-Treiber



240 W  
10.00 A  
L: 244 mm  
B: 71 mm  
H: 37.5 mm

**Informationen**

- Spannung und Strombegrenzung auf der Rückseite einstellbar
- mit Anschlusskabel PRI (0.3 m / 3 x 1.0 mm<sup>2</sup>)
- mit Anschlusskabel SEC (0.3 m / 2 x 1.0 mm<sup>2</sup>)

Leistung	Art.-Nr.	CHF
240 W	200-002-240	179.00

## 320 W | Konstantspannungs-Treiber



320 W  
Flicker <20%  
L: 252 mm  
B: 90 mm  
H: 43.8 mm

**Informationen**

- Spannung und Strombegrenzung einstellbar
- mit Anschlusskabel PRI (0.3 m / 3 x 1.0 mm<sup>2</sup>)
- mit Anschlusskabel SEC (0.3 m / 2 x 2.0 mm<sup>2</sup>)

Leistung	Art.-Nr.	CHF
320 W	200-002-320	299.00

## 480 W | Konstantspannungs-Treiber



480 W  
Flicker <20%  
L: 262 mm  
B: 125 mm  
H: 43.8 mm

**Informationen**

- 2 Ausgänge (2 x 10 A max.)
- Spannung und Strombegrenzung einstellbar
- mit Anschlusskabel PRI (0.3 m / 3 x 1.0 mm<sup>2</sup>)
- mit Anschlusskabel SEC (2 x 0.3 m / 2 x 1.0 mm<sup>2</sup>)

Leistung	Art.-Nr.	CHF
480 W	200-002-480	399.00

## 25 W | Konstantspannungs-Treiber

NEW



25 W  
 Dimmbereich >1%  
 Flicker <1%  
 $P_{out}$  2.5 – 25 W  
 L: 127 mm  
 B: 52 mm  
 H: 30 mm



### Informationen

- DC tauglich

Leistung	Art.-Nr.	CHF
25 W	200-003-026	69.00

## 50 W | Konstantspannungs-Treiber

NEW



50 W  
 2.08 A  
 Dimmbereich >5%  
 Flicker <10%  
 $P_{out}$  12 – 50 W  
 L: 184 mm  
 B: 61 mm  
 H: 32 mm



### Informationen

- DC tauglich

Leistung	Art.-Nr.	CHF
50 W	200-003-051	99.00

## 100 W | Konstantspannungs-Treiber

NEW



100 W  
 4.17 A  
 Dimmbereich >5%  
 Flicker <10%  
 $P_{out}$  34 – 100 W  
 L: 210 mm  
 B: 67 mm  
 H: 34 mm

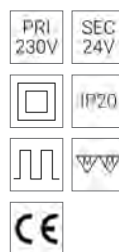

### Informationen

- DC tauglich

Leistung	Art.-Nr.	CHF
100 W	200-003-101	159.00

## 200 W | Konstantspannungs-Treiber



200 W  
8.33 A  
Dimmbereich >5%  
Flicker <5%  
 $P_{out}$  65 – 200 W  
L: 249 mm  
B: 72 mm  
H: 40 mm

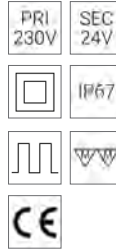

### Informationen

- mit Anschlusskabel PRI (0.24 m / 3 x 1.0 mm<sup>2</sup>)
- mit Anschlusskabel SEC (0.24 m / 2 x 2.0 mm<sup>2</sup>)

Leistung	Art.-Nr.	CHF
200 W	200-003-200	214.00

## 35 W | Konstantspannungs-Treiber



35 W  
Dimmbereich >1%  
L: 195 mm  
B: 43 mm  
H: 30.2 mm

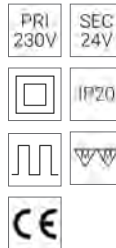

### Informationen

- DC tauglich
- DALI oder Tasterdimmung
- corridorFUNCTION

Leistung	Art.-Nr.	CHF
35 W	200-020-035	129.00

## 50 W | Konstantspannungs-Treiber

4-Kanal



18 – 50 W  
Dimmbereich >1%  
L: 345 mm  
B: 32 mm  
H: 22 mm

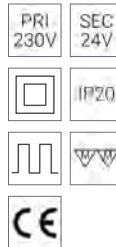

### Informationen

- DC tauglich
- DALI 2 oder Tasterdimmung
- DT6 oder DT8 Tunable White (DIP Switch)
- passt in das Profil Modular

Leistung	Art.-Nr.	CHF
18 – 50 W	200-010-051	159.00

## 80 W | Konstantspannungs-Treiber

4-Kanal



30 – 80 W  
 Dimmbereich >1%  
 L: 345 mm  
 B: 32 mm  
 H: 22 mm

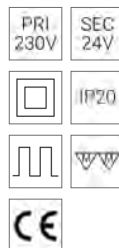

### Informationen

- DC tauglich
- DALI 2 oder Tasterdimmung
- DT6 oder DT8 Tunable White (DIP Switch)
- passt in das Profil Modular

Leistung	Art.-Nr.	CHF
30 – 80 W	200-010-081	199.00

## 160 W | Konstantspannungs-Treiber

2-Kanal



60 – 160 W  
 Dimmbereich >1%  
 L: 300 mm  
 B: 50 mm  
 H: 35 mm

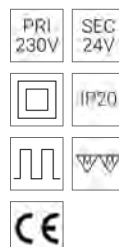

### Informationen

- DC tauglich
- DALI 2 oder Tasterdimmung
- DT6 oder DT8 Tunable White (DIP Switch)

Leistung	Art.-Nr.	CHF
60 – 160 W	200-010-161	289.00



**3 W | Konstantstrom-Treiber**

350 mA

**NEW**

3 W  
L: 65 mm  
B: 29 mm  
H: 18 mm



Bestromung	Vorwärtsspannung	Art.-Nr.	CHF
350 mA	U <sub>out</sub> 2.7 – 10 V	25798-350-03	27.00

**20 W | Konstantstrom-Treiber**

350 / 500 / 700 mA



20 W  
Flicker <5%  
L: 113 mm  
B: 44 mm  
H: 28 mm

**Informationen**

- DC tauglich

Bestromung	Vorwärtsspannung	Art.-Nr.	CHF
350 mA	U <sub>out</sub> 2 – 58 V	043-350-20	40.00
500 mA	U <sub>out</sub> 2 – 40 V	043-500-20	40.00
700 mA	U <sub>out</sub> 2 – 29 V	043-700-20	40.00

**40 W | Konstantstrom-Treiber**

700 / 900 mA



40 W  
Flicker <5%  
L: 127 mm  
B: 43 mm  
H: 28 mm



Bestromung	Vorwärtsspannung	Art.-Nr.	CHF
700 mA	U <sub>out</sub> 29 – 57 V	043-700-42	54.00
900 mA	U <sub>out</sub> 22 – 44 V	043-900-42	64.00

### 4 W | Konstantstrom-Treiber

350 mA



4 W  
 $U_{out}$  3 – 12 V  
 L: 79 mm  
 B: 43.5 mm  
 H: 25.5 mm



#### Informationen

- mit Anschlusskabel PRI (0.3 m / 2 x 0.75 mm<sup>2</sup>)
- mit Anschlusskabel SEC (0.2 m / 2 x 0.75 mm<sup>2</sup>)

Bestromung	Art.-Nr.	CHF
350 mA	27440-350-05	42.00

### 4 W | Konstantstrom-Treiber

700 mA



4 W  
 $U_{out}$  3 – 6 V  
 L: 79 mm  
 B: 43.5 mm  
 H: 25.5 mm



#### Informationen

- mit Anschlusskabel PRI (0.3 m / 2 x 0.75 mm<sup>2</sup>)
- mit Anschlusskabel SEC (0.2 m / 2 x 0.75 mm<sup>2</sup>)

Bestromung	Art.-Nr.	CHF
700 mA	27440-700-05	42.00

### 4 W | Konstantstrom-Treiber

500 / 700 mA



4 W  
 Flicker <5%  
 L: 54 mm  
 B: 27 mm  
 H: 21 mm



#### Informationen

- mit Anschlusskabel PRI (0.18 m / 2 x 0.5 mm<sup>2</sup>)
- mit Anschlusskabel SEC (0.18 m / 2 x 0.75 mm<sup>2</sup>)
- Treiber zum Einbauen

Bestromung	Vorwärtsspannung	Art.-Nr.	CHF
500 mA	$U_{out}$ 2 – 8 V	043-500-04	30.00
700 mA	$U_{out}$ 2 – 6 V	043-700-04	30.00

**9 W | Konstantstrom-Treiber**

260 mA



9 W  
 Dimmbereich >5%  
 Flicker <15%  
 $U_{out}$  15 – 35 V  
 L: 100 mm  
 B: 40 mm  
 H: 22 mm



Bestromung	Art.-Nr.	CHF
260 mA	043-260-09	47.00

**9 W | Konstantstrom-Treiber**

350 mA

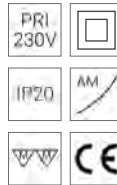

9 W  
 Dimmbereich >5%  
 Flicker <15%  
 $U_{out}$  11 – 26 V  
 L: 100 mm  
 B: 40 mm  
 H: 22 mm

**Informationen**

- mit Anschlusskabel PRI (0.15 m / 2 x 0.75 mm<sup>2</sup>)
- mit Anschlusskabel SEC (0.3 m / 2 x 0.75 mm<sup>2</sup>) mit Stecker

Bestromung	Art.-Nr.	CHF
350 mA	043-350-12	47.00

**12 W | Konstantstrom-Treiber**

260 / 350 mA



12 W  
 Dimmbereich >5%  
 Flicker <5%  
 L: 100 mm  
 B: 40 mm  
 H: 22 mm

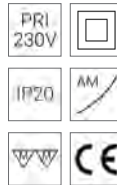

Bestromung	Vorwärtsspannung	Art.-Nr.	CHF
260 mA	$U_{out}$ 24 – 46 V	043-260-12	48.00
350 mA	$U_{out}$ 18 – 35 V	043-350-13	48.00

### 12 W | Konstantstrom-Treiber

500 mA



12 W  
 Dimmbereich >5%  
 Flicker <5%  
 $U_{out}$  12 – 24 V  
 L: 100 mm  
 B: 40 mm  
 H: 22 mm



**Informationen**

- mit Anschlusskabel PRI (0.15 m / 2 x 0.75 mm<sup>2</sup>)
- mit Anschlusskabel SEC (0.3 m / 2 x 0.75 mm<sup>2</sup>) mit Stecker

Bestromung	Art.-Nr.	CHF
500 mA	043-500-12	48.00

### 18 W | Konstantstrom-Treiber

350 mA



18 W  
 Dimmbereich >5%  
 Flicker <5%  
 $U_{out}$  28 – 56 V  
 L: 113 mm  
 B: 44 mm  
 H: 28 mm



Bestromung	Art.-Nr.	CHF
350 mA	043-350-18	59.00

### 22 W | Konstantstrom-Treiber

500 mA



22 W  
 Dimmbereich >5%  
 Flicker <5%  
 $U_{out}$  20 – 44 V  
 L: 113 mm  
 B: 44 mm  
 H: 28 mm



Bestromung	Art.-Nr.	CHF
500 mA	043-500-22	59.00



**22 W | Konstantstrom-Treiber**

700 mA



22 W  
 Dimmbereich >5%  
 Flicker <5%  
 $U_{out}$  14 – 32 V  
 L: 113 mm  
 B: 44 mm  
 H: 28 mm

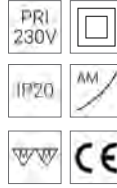

Bestromung	Art.-Nr.	CHF
700 mA	043-700-22	59.00

**40 W | Konstantstrom-Treiber**

700 mA

**NEW**

40 W  
 Dimmbereich >8%  
 Flicker <30%  
 $U_{out}$  28 – 56 V  
 L: 166 mm  
 B: 52 mm  
 H: 24 mm

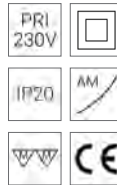
**Informationen**

- DC tauglich

Bestromung	Art.-Nr.	CHF
700 mA	200-006-002	64.00

**40 W | Konstantstrom-Treiber**

900 mA

**NEW**

40 W  
 Dimmbereich >5%  
 Flicker <5%  
 $U_{out}$  22 – 44 V  
 L: 166 mm  
 B: 52 mm  
 H: 25 mm

**Informationen**

- DC tauglich

Bestromung	Art.-Nr.	CHF
900 mA	200-007-001	74.00

## 45 W | Konstantstrom-Treiber

1050 mA



45 W

Dimmbereich >5%

Flicker <15%

$U_{out}$  22 – 43 V

L: 166 mm

B: 53 mm

H: 23 mm

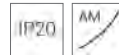

### Informationen

- DC tauglich

Bestromung

1050 mA

Art.-Nr.

200-004-001

CHF

84.00

## 10 W rund | Multi-Konstantstrom-Treiber

260 / 350 mA



### Informationen

- passt in 62 mm Bohrloch
- DALI 2 oder Tasterdimmung
- Werkseinstellung: 260 mA
- mit Anschlusskabel (0.12 m / 2 x 0.75 mm<sup>2</sup>)

Bestimmung	Art.-Nr.	CHF
260 / 350 mA	200-018-010	74.00

### DIP Switch Position

I <sub>out</sub>	U <sub>out</sub>	1	2
260 mA	6 – 28 V	Up	Up
350 mA	6 – 28 V	Down	Down

10 W  
Dimmbereich >1%  
Ø: 57 mm  
H: 24 mm



## 10 W rund | Multi-Konstantstrom-Treiber

500 / 700 mA



### Informationen

- passt in 62 mm Bohrloch
- DALI 2 oder Tasterdimmung
- Werkseinstellung: 500 mA
- mit Anschlusskabel (0.12 m / 2 x 0.75 mm<sup>2</sup>)

Bestimmung	Art.-Nr.	CHF
500 / 700 mA	200-019-010	74.00

### DIP Switch Position

I <sub>out</sub>	U <sub>out</sub>	1	2
500 mA	6 – 20 V	Up	Up
700 mA	6 – 14 V	Down	Down

10 W  
Dimmbereich >1%  
Ø: 57 mm  
H: 24 mm



## 12 W | Multi-Konstantstrom-Treiber

180 – 500 mA



12 W  
 Dimmbereich >1%  
 Flicker <5%  
 L: 119 mm  
 B: 52 mm  
 H: 23 mm

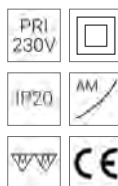

### Informationen

- DC tauglich
- DALI 2 oder Tasterdimmung
- passt in 68 mm Bohrloch
- Werkseinstellung: 180 mA
- mit Anschlusskabel SEC (0.3 m / 2 x 0.75 mm<sup>2</sup>) mit Stecker

Bestromung	Art.-Nr.	CHF
180 – 500 mA	043-001-012	69.00

### DIP Switch Position

I <sub>out</sub>	U <sub>out</sub>	1	2	3	4
180 mA	18 – 54 V	-	-	-	-
230 mA	18 – 52 V	ON	-	-	-
260 mA	15 – 46 V	-	-	-	ON
300 mA	15 – 42 V	ON	-	-	ON
350 mA	15 – 34 V	-	-	ON	-
400 mA	15 – 30 V	ON	-	ON	-
450 mA	15 – 27 V	-	ON	ON	-
500 mA	15 – 24 V	ON	ON	ON	-

## 25 W | Multi-Konstantstrom-Treiber

260 – 700 mA



25 W  
 Dimmbereich >1%  
 Flicker <5%  
 L: 119 mm  
 B: 52 mm  
 H: 23 mm

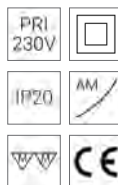

### Informationen

- DC tauglich
- DALI 2 oder Tasterdimmung
- passt in 68 mm Bohrloch
- Werkseinstellung: 260 mA
- mit Anschlusskabel SEC (0.3 m / 2 x 0.75 mm<sup>2</sup>) mit Stecker

Bestromung	Art.-Nr.	CHF
260 – 700 mA	043-001-025	74.00

### DIP Switch Position

I <sub>out</sub>	U <sub>out</sub>	1	2	3
260 mA	20 – 60 V	-	-	-
350 mA	20 – 60 V	ON	-	-
400 mA	20 – 60 V	-	ON	-
450 mA	20 – 55 V	-	-	ON
500 mA	20 – 50 V	ON	ON	-
550 mA	20 – 45 V	ON	-	ON
600 mA	20 – 42 V	-	ON	ON
700 mA	20 – 36 V	ON	ON	ON



**25 W Tunable White | Multi-Konstantstrom-Treiber**

260 – 700 mA



25 W  
 Dimmbereich >1%  
 L: 124 mm  
 B: 64 mm  
 H: 23 mm

**Informationen**

- DC tauglich
- DALI 2 DT8 oder Tasterdimmung
- nur eine DALI Adresse für die TW-Steuerung
- passt in 68 mm Bohrloch
- PushDim: Farben mischen und Helligkeit anpassen mit 2 Taster oder Doppel-Drucktaster (z.B. Feller EDIZIOdue)
- kompatibel mit folgenden Drehregler:  
 Unex DT8 TW, Feller TW DALI (E-No: 548 510 000),  
 Osram DALI MCU TW
- Werkseinstellung: 260 mA

Bestromung	Art.-Nr.	CHF
260 – 700 mA	043-002-025	89.00

**DIP Switch Position**

$I_{out}$	$U_{out}$	1	2	3	4
260 mA	10 – 50 V	-	-	-	-
350 mA	10 – 50 V	ON	-	-	-
400 mA	10 – 50 V	-	ON	-	-
450 mA	10 – 50 V	-	-	ON	-
500 mA	10 – 50 V	ON	ON	-	-
550 mA	10 – 45 V	ON	-	ON	-
600 mA	10 – 42 V	-	-	-	ON
700 mA	10 – 36 V	ON	-	-	ON

**45 W | Multi-Konstantstrom-Treiber**

350 – 1050 mA

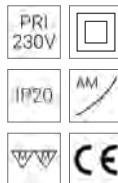

45 W  
 Dimmbereich >1%  
 L: 135 mm  
 B: 73 mm  
 H: 25 mm

**Informationen**

- DC tauglich
- DALI 2 oder Tasterdimmung
- Werkseinstellung: 350 mA

Bestromung	Art.-Nr.	CHF
350 – 1050 mA	043-001-045	109.00

**DIP Switch Position**

$I_{out}$	$U_{out}$	1	2	3
350 mA	25 – 75 V	-	-	-
500 mA	25 – 75 V	ON	-	-
600 mA	25 – 75 V	-	ON	-
700 mA	25 – 64 V	ON	ON	-
800 mA	25 – 56 V	ON	-	ON
900 mA	25 – 50 V	-	ON	ON
1050 mA	21 – 43 V	ON	ON	ON

# 50 W Tunable White | Multi-Konstantstrom-Treiber

250 – 1500 mA



50 W  
 Dimmbereich >0.1%  
 L: 210 mm  
 B: 50 mm  
 H: 32 mm



### Informationen

- DALI 2 DT8 oder Tasterdimmung
- nur eine DALI Adresse für die TW-Steuerung
- passt in 68 mm Bohrloch
- PushDim: Farben mischen und Helligkeit anpassen mit nur einem Taster
- kompatibel mit folgenden Drehregler:  
 Unex DT8 TW, Feller TW DALI (E-No: 548 510 000),  
 Osram DALI MCU TW
- Werkseinstellung: 250 mA

Bestromung	Art.-Nr.	CHF
250 – 1500 mA	25716-024-99	149.00

### DIP Switch Position

$I_{out}$	$U_{out}$	1	2	3	4
250 mA	8 – 52 V	-	-	-	-
300 mA	8 – 52 V	-	-	-	ON
350 mA	8 – 52 V	-	-	ON	-
400 mA	8 – 52 V	-	-	ON	ON
450 mA	8 – 52 V	-	ON	-	-
500 mA	8 – 52 V	-	ON	-	ON
550 mA	8 – 52 V	-	ON	ON	-
600 mA	8 – 52 V	-	ON	ON	ON
650 mA	8 – 52 V	ON	-	-	-
700 mA	8 – 52 V	ON	-	-	ON
750 mA	8 – 52 V	ON	-	ON	-
800 mA	8 – 52 V	ON	-	ON	ON
850 mA	8 – 52 V	ON	ON	-	-
900 mA	8 – 52 V	ON	ON	-	ON
950 mA	8 – 52 V	ON	ON	ON	-
1000 mA	8 – 50 V	ON	ON	ON	ON

**60 W | Multi-Konstantstrom-Treiber**

350 – 1050 mA



60 W  
Dimmbereich >1%  
L: 124 mm  
B: 79 mm  
H: 22 mm

**Informationen**

- DC tauglich
- Werkseinstellung: 350 mA

Bestromung	Art.-Nr.	CHF
350 – 1050 mA	556-050-50	129.00

**DIP Switch Position**

$I_{out}$	$U_{out}$	Leistung	6	5	4	3	2	1
350 mA	2 – 74 V	25 W	-	-	-	-	-	-
500 mA	2 – 72 V	35 W	ON	-	-	-	-	-
550 mA	2 – 72 V	39 W	-	ON	-	-	-	-
650 mA	2 – 72 V	46 W	ON	-	-	ON	-	-
700 mA	2 – 72 V	50 W	ON	ON	-	-	-	-
750 mA	2 – 72 V	54 W	-	ON	ON	-	-	-
850 mA	2 – 70 V	60 W	ON	-	-	-	ON	-
900 mA	2 – 66 V	60 W	ON	ON	ON	-	-	-
1000 mA	2 – 60 V	60 W	ON	-	-	ON	ON	-
1050 mA	2 – 57 V	60 W	ON	ON	ON	ON	-	-

**80 W | Multi-Konstantstrom-Treiber**

350 – 1400 mA

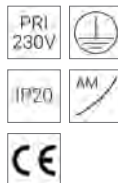

80 W  
Dimmbereich >1%  
L: 359 mm  
B: 30 mm  
H: 21 mm

**Informationen**

- DC tauglich
- DALI 2 oder Tasterdimmung
- Werkseinstellung: 350 mA
- passt in das Profil Modular

Bestromung	Art.-Nr.	CHF
350 – 1400 mA	200-011-080	109.00

**DIP Switch Position**

$I_{out}$	$U_{out}$	Leistung	1	2	3	4	5
350 mA	20 – 56 V	19.5 W	-	-	-	-	-
500 mA	20 – 56 V	28 W	ON	ON	-	-	-
700 mA	20 – 56 V	39 W	ON	ON	ON	-	-
900 mA	20 – 56 V	50 W	ON	ON	-	-	ON
1000 mA	20 – 56 V	56 W	ON	-	ON	-	ON
1200 mA	20 – 56 V	67 W	ON	ON	-	ON	ON
1400 mA	20 – 56 V	78 W	ON	ON	ON	ON	ON

## EMLED DALI 2 | Notlichtelement

längliche Bauform für optimale Integration in Profile

NEW



Flicker <1%

U<sub>out</sub> 6 – 54 V

L: 173 mm

B: 30 mm

H: 21 mm



### Informationen

- DC tauglich
- vollautomatischer Selbsttest
- 2.3 W bei Notbetrieb
- Empfehlung im Notbetrieb: 10% vom Leuchtenlichtstrom
- fertig in Profil montiert
- funktioniert mit Konstantspannungs- und Konstantstrom-Leuchten
- mit 3 Stunden LiFePO4 Akku
- mit 2-farbiger LED-Statusanzeige
- mit Zugentlastung, optional zu montieren
- Parametrierung und Überwachung von Tests über DALI
- LxBxH mit Abdeckungen: 200 x 25 x 25 mm

Variante	Art.-Nr.	CHF
	UD-211-002-200	• 299.00

Ersatzteil	Art.-Nr.	CHF
Akku-Pack	211-002-000	54.00



## Built-in PWM | Touch-Dimmer

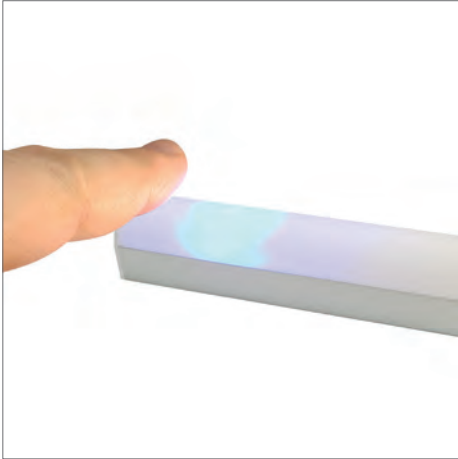

max. 3 A
Dimmbereich >1%
PRI 12 – 36 V dc
SEC 12 – 36 V dc
L: 42 mm
B: 10 mm
H: 10 mm



### Informationen

- fertig montiert unter Diffusor
- 72 W bei 24 V
- stufenloses Dimmen
- blaue LED-Anzeige
- lässt sich in folgende Profile fertig montiert bestellen:  
Linea 20 (Diffusor rund), Bow, Duplex, Tube 26, Corner 16

Variante	Art.-Nr.	CHF
	UD-210-002-00	• 54.00

## Funk 4-Kanal | Steuermodul

1-farbig / TW / RGB(W)



Dimmbereich >1%
PRI 12 – 36 V dc
SEC 12 – 36 V dc
L: 167 mm
B: 29.6 mm
H: 20 mm

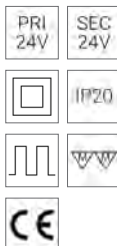

### Informationen

- total 10 A
- 240 W bei 24 V / 120 W bei 12 V
- Reichweite max. 20 Meter
- 8 Bedienungselemente können sich mit dem Steuermodul verbinden
- 1 Taster-Eingang (potentialfreier Kontakt, nur Weiss dimmbar)
- passt in das Profil Modular
- ideal in Kombination mit schlankem 24 V Konstantspannungs-Treiber

Variante	Art.-Nr.	CHF
	25716-009-99	109.00

## DALI | Steuermodul



Dimmbereich >0.1%  
 PRI 12 – 36 V dc  
 SEC 12 – 36 V dc  
 L: 167 mm  
 B: 29.6 mm  
 H: 20 mm

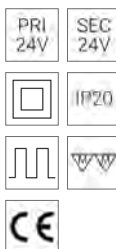

### Informationen

- max. 10 A
- 240 W bei 24 V / 120 W bei 12 V
- gleichmässiges Dimmverhalten
- DALI 2 oder Tasterdimmung
- flache Bauform
- passt in das Profil Modular
- ideal in Kombination mit schlankem 24 V Konstantspannungs-Treiber

Variante	Art.-Nr.	CHF
	25716-008-99	109.00

## DALI Tunable White | Steuermodul

DT8



Dimmbereich >0.1%  
 PRI 12 – 24 V dc  
 SEC 12 – 24 V dc  
 L: 167 mm  
 B: 29.6 mm  
 H: 20 mm

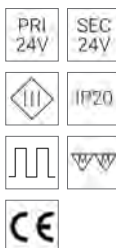

### Informationen

- max. 4 x 2.5 A
- 4 x 60 W bei 24 V
- nur eine DALI Adresse für die TW-Steuerung
- flache Bauform
- passt in das Profil Modular
- PushDim: Farben mischen und Helligkeit anpassen mit nur einem Taster
- kompatibel mit folgenden Drehregler:  
 Unex DT8 TW, Feller TW DALI (E-No: 548 510 000),  
 Osram DALI MCU TW

Variante	Art.-Nr.	CHF
	25716-008-79	144.00

**DALI RGB(W) | Steuermodul**

DT8

**Informationen**

- max. 4 x 2.5 A
- 4 x 60 W bei 24 V
- nur eine DALI Adresse für eine optimale Mischung der Farben
- flache Bauform
- passt in das Profil Modular
- PushDim: Farben mischen und Helligkeit anpassen mit nur einem Taster
- für einen höheren Lumenoutput ist im RGB(W)-Modus Weiss immer aktiviert (nur mit PushDim oder Unex Drehregler DT8 RGB)
- kompatibel mit Unex Drehregler DT8 RGB

Dimmbereich &gt;0.1%

PRI 12 – 24 V dc

SEC 12 – 24 V dc

L: 167 mm

B: 29.6 mm

H: 20 mm



Variante	Art.-Nr.	CHF
	25716-008-89	144.00

**DALI IP67, 4-Kanal | Steuermodul**

1-farbig / TW / RGB(W)

**Informationen**

- 4 x 120 W bei 24 V
- mit Anschlusskabel PRI (0.4 m / 4 x 0.75 mm<sup>2</sup>)
- mit Anschlusskabel SEC (0.4 m / 5 x 0.75 mm<sup>2</sup>)
- Serienverkabelung möglich
- DALI 2 oder Tasterdimmung
- 4-Kanäle für 1-farbige, TW oder RGB(W) Steuerung

480 W

Dimmbereich &gt;0.1%

PRI 12 – 24 V dc

SEC 12 – 24 V dc

L: 181 mm

B: 74 mm

H: 38 mm



Variante	Art.-Nr.	CHF
	25716-022-99	169.00

Phasenabschnitt/DALI | Steuermodul

NEW



Informationen

- Umwandler von DALI auf Phasenabschnitt (max. 200 W)
- Anschluss: max. 10 Treiber/Leuchten oder max. 200 W
- einstellbares Minimum
- DALI 2 oder Tasterdimmung
- kompatibel mit Unex Phasenabschnitt Treibern und Leuchten
- passt in UP Dose E-No. 372 002 929

2 – 200 W  
 Dimmbereich >5%  
 L: 45 mm  
 B: 45 mm  
 H: 20.5 mm

PRI 230V IP20  
 CE

Variante	Art.-Nr.	CHF
	210-007-000	89.00



## Taster/Bluetooth | Steuermodul

tiefste Dimmwerte



2 – 300 W  
Dimmbereich >5%  
L: 45 mm  
B: 45 mm  
H: 22 mm



### Informationen

- einstellbares Minimum
- Reichweite max. 20 Meter
- kompatibel mit Drucktaster E-No. 554 528 000 (EBT: 50 mm)
- kompatibel mit Unex Phasenabschnitt Treibern
- passt in UP Dose E-No. 372 002 929
- App «Unex LED BT» für iOS und Android im jeweiligen Store
- Bluetooth 3.0
- 1 Taster-Eingang (potentialfreier Kontakt)
- mehrerer Taster anschliessbar

Variante	Art.-Nr.	CHF
	210-001-01	89.00

## Taster/ZigBee | Steuermodul

für die perfekte Integration in Smart Home Systeme

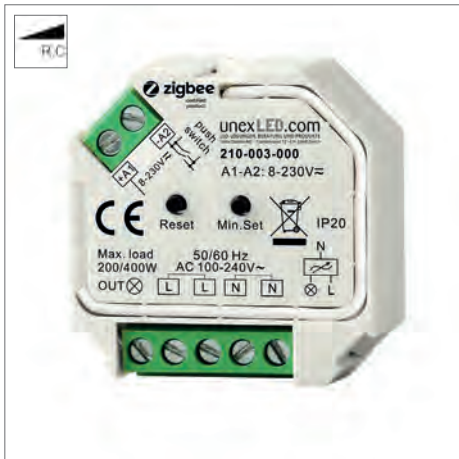

2 – 200 W  
Dimmbereich >5%  
L: 45 mm  
B: 45 mm  
H: 20.5 mm



### Informationen

- Reichweite max. 20 Meter
- kompatibel mit Drucktaster E-No. 554 528 000 (EBT: 50 mm)
- kompatibel mit Unex Phasenabschnitt Treibern
- passt in UP Dose E-No. 372 002 929
- Zigbee 3.0 Standard-Protokoll
- einstellbares Minimum
- integrierbar in Smart Home Systeme (Google Assistant, Amazon Alexa und Philips Hue)
- 1 Taster-Eingang (230V Anschluss)

Variante	Art.-Nr.	CHF
	210-003-000	89.00

## DALI/Zigbee | Steuermodul

für die perfekte Integration in Smart Home Systeme

NEW



### Informationen

- Reichweite max. 15 Meter
- kann bis zu 8 DALI Treiber im Broadcast-Modus steuern
- kompatibel mit DALI DT6 und DT8 Tunable White Treiber
- Zigbee 3.0 Standard-Protokoll
- integrierbar in Smart Home Systeme (Google Assistant, Amazon Alex und Philips Hue)

L: 108 mm

B: 30 mm

H: 21 mm

PRI  
230V

IP20

CE

Variante

Art.-Nr.

CHF

210-008-000

109.00

## Casambi 4-Kanal | Steuermodul

1-farbig / TW / RGB(W)



Dimmbereich >1%

PRI 10 – 24 V dc

SEC 10 – 24 V dc

L: 172 mm

B: 42 mm

H: 20 mm



### Informationen

- max. 10 A
- 240 W bei 24 V
- Reichweite max. 20 Meter
- Radio Signal 2.4 GHz
- 2 Taster-Eingänge (potentialfreier Kontakt)
- einfach zu bedienen mit der Casambi App
- weitere Funktionalitäten wie Tageslichtverlauf

Variante	Art.-Nr.	CHF
	200-240-024	269.00

## DALI/Casambi | Steuermodul

Kleine Bauform für optimale Integration in Leuchten oder Profile

NEW



L: 80.7 mm

B: 30 mm

H: 15.3 mm



### Informationen

- Reichweite max. 20 Meter
- kompatibel/integrierbar in Casambi Installationen (Radio Signal 2,4GHz)
- einfach zu bedienen mit der Casambi App oder dem Wandtaster 210-010-000
- programmierbar, für eine einfache Implementierung von RGB und Farbtemperaturregelung
- weitere Funktionalitäten wie Tageslichtverlauf
- mit integrierter DALI Stromversorgung
- kann bis zu 5 DALI Leuchten steuern
- 1 Taster-Eingang (potentialfreier Kontakt)
- passt in das Profil Modular
- passt in UP Dose E-No. 372 002 929

Variante	Art.-Nr.	CHF
	210-006-000	149.00

## DALI/Casambi | Steuermodul

NEW



L: 119 mm

B: 30 mm

H: 21 mm

PRI  
230V



IP20



### Informationen

- Reichweite max. 20 Meter
- kompatibel/integrierbar in Casambi Installationen (Radio Signal 2,4GHz)
- einfach zu bedienen mit der Casambi App
- programmierbar, für eine einfache Implementierung von RGB und Farbtemperaturregelung
- weitere Funktionalitäten wie Tageslichtverlauf
- mit integrierter DALI Stromversorgung
- bis zu 25 DALI Leuchten steuerbar
- 1 Taster-Eingang (230V Anschluss)

Variante	Art.-Nr.	CHF
	210-011-000	189.00

Zubehör	Art.-Nr.	CHF
Zugentlastung	210-011-900	35.00



**Funktaster 1-farbig**

für 1 Zone



B: 86 mm  
H: 86 mm  
T: 14 mm

**Informationen**

- Reichweite max. 20 Meter
- inkl. Batterie
- kompatibel mit 4-Kanal Funk-Steuermodul
- max. 30 Empfänger
- letzter Wert nach nach Ausschaltung wird gespeichert
- einfach zu installieren
- inkl. Adapter-Rahmen für Modularsystem Feller Edizio
- für Aufputz-Installation geeignet ab 2-fach Abdeckrahmen
- dank Klebestreifen auch für Unterputz-Installation geeignet

Variante	Art.-Nr.	CHF
	25716-012-99	109.00

**Funktaster 1-farbig**

für 2 Zonen



B: 86 mm  
H: 86 mm  
T: 14 mm

**Informationen**

- Reichweite max. 20 Meter
- inkl. Batterie
- kompatibel mit 4-Kanal Funk-Steuermodul
- max. 30 Empfänger
- letzter Wert nach nach Ausschaltung wird gespeichert
- einfach zu installieren
- inkl. Adapter-Rahmen für Modularsystem Feller Edizio
- für Aufputz-Installation geeignet ab 2-fach Abdeckrahmen
- dank Klebestreifen auch für Unterputz-Installation geeignet

Variante	Art.-Nr.	CHF
	25716-013-99	109.00

## Funktaster Tunable White

für 1 Zone



B: 86 mm

H: 86 mm

T: 14 mm



### Informationen

- Reichweite max. 20 Meter
- inkl. Batterie
- kompatibel mit 4-Kanal Funk-Steuermodul
- max. 30 Empfänger pro Taster
- letzter Wert nach nach Ausschaltung wird gespeichert
- einfach zu installieren
- inkl. Adapter-Rahmen für Modularsystem Feller Edizio
- für Aufputz-Installation geeignet ab 2-fach Abdeckrahmen
- dank Klebestreifen auch für Unterputz-Installation geeignet

Variante

Art.-Nr.

CHF

25716-014-99

109.00

## Funktaster RGB

für 1 Zone



B: 86 mm

H: 86 mm

T: 14 mm



### Informationen

- Reichweite max. 20 Meter
- inkl. Batterie
- kompatibel mit 4-Kanal Funk-Steuermodul
- max. 30 Empfänger
- letzter Wert nach nach Ausschaltung wird gespeichert
- einfach zu installieren
- inkl. Adapter-Rahmen für Modularsystem Feller Edizio
- für Aufputz-Installation geeignet ab 2-fach Abdeckrahmen
- dank Klebestreifen auch für Unterputz-Installation geeignet

Variante

Art.-Nr.

CHF

25716-015-99

109.00

## Fernbedienung 1-farbig

für 1 Zone



B: 35 mm  
H: 140 mm  
T: 8.5 mm



### Informationen

- Reichweite max. 20 Meter
- inkl. Batterie
- kompatibel mit 4-Kanal Funk-Steuermodul
- max. 30 Empfänger

Variante	Art.-Nr.	CHF
	25716-021-99	74.00

## Fernbedienung Tunable White

für 1 Zone



B: 35 mm  
H: 140 mm  
T: 8.5 mm



### Informationen

- Reichweite max. 20 Meter
- inkl. Batterie
- kompatibel mit 4-Kanal Funk-Steuermodul
- max. 30 Empfänger

Variante	Art.-Nr.	CHF
	25716-016-99	74.00

## Fernbedienung RGB(W)

für 4 Zonen



B: 51 mm  
H: 152 mm  
T: 18 mm



### Informationen

- Reichweite max. 20 Meter
- inkl. Batterie
- kompatibel mit 4-Kanal Funk-Steuermodul
- max. 30 Empfänger

Variante	Art.-Nr.	CHF
	25716-017-99	129.00

### Wand-Controller Tunable White

für 4 Zonen



B: 86 mm  
H: 86 mm  
T: 19.4 mm



#### Informationen

- Reichweite max. 20 Meter
- kompatibel mit 4-Kanal Funk-Steuermodul
- max. 30 Empfänger
- mit 230 V Einspeisung

Variante	Art.-Nr.	CHF
	25716-019-99	129.00

### Wand-Controller RGB(W)

für 4 Zonen



B: 86 mm  
H: 86 mm  
T: 19.4 mm



#### Informationen

- Reichweite max. 20 Meter
- kompatibel mit 4-Kanal Funk-Steuermodul
- max. 30 Empfänger
- mit 230 V Einspeisung

Variante	Art.-Nr.	CHF
	25716-020-99	129.00

### Wandtaster Casambi

für 1-farbig, TW und RGB(W), mit der Casambi App programmierbar



B: 90 mm  
H: 90 mm  
T: 12 mm



#### Informationen

- als Wandtaster oder als Fernbedienung einsetzbar
- 4 Tasten für schnelle Szenenwahl
- stufenloses Dimmen
- in Verbindung mit Tunable White Steuerung lässt sich die Farbtemperatur in 25 Kelvin-Schritten ändern
- Reichweite max. 60 Meter
- batteriebetrieben (CR2430)

Variante	Art.-Nr.	CHF
	210-010-000	249.00



## Phasenabschnitt | Drehregler



B: 54 mm  
H: 54 mm  
T: 42 mm  
ET: 24 mm



### Informationen

- einstellbares Minimum
- letzter Dimmwert bleibt auch nach Stromausfall gespeichert
- Leistung: 2 – 350 W
- stufenloses Dimmen
- kompatibel mit Feller Modulare System Edizio
- ohne Abdeckset

Empfohlenes Zubehör von Feller

für Einbau: Abdeckset (E-Nr. 378 342 000)

für Aufbau: Abdeckset (E-Nr. 378 340 000),

Kappe mit Befestigungsbügel (E-Nr. 283 901 000)

Variante	Art.-Nr.	CHF
	210-005-000	109.00

## DALI | Drehregler



B: 54 mm  
H: 54 mm  
T: 43 mm  
ET: 24 mm



### Informationen

- selbstversorgt
- einstellbares Minimum
- letzter Dimmwert bleibt auch nach Stromausfall gespeichert
- bis zu 25 Leuchten pro Drehregler steuerbar
- kompatibel mit Feller Modulare System Edizio
- ohne Abdeckset

Empfohlenes Zubehör von Feller

für Einbau: Abdeckset (E-Nr. 378 342 000)

für Aufbau: Abdeckset (E-Nr. 378 340 000),

Kappe mit Befestigungsbügel (E-Nr. 283 901 000)

Variante	Art.-Nr.	CHF
	210-004-000	129.00

## DALI | Drehregler Tunable White

DT8



B: 58 mm

H: 58 mm

T: 50.7 mm

ET: 32 mm



### Informationen

- selbstversorgt
- kompatibel mit DT8 DALI Treiber
- bis zu 50 Leuchten pro Drehregler steuerbar
- kompatibel mit Feller Modularesystem Edizio
- ohne Abdeckset

Empfohlenes Zubehör von Feller

für Einbau: Abdeckset (E-Nr. 378 342 000)

für Aufbau: Abdeckset (E-Nr. 378 340 000),

Kappe mit Befestigungsbügel (E-Nr. 283 901 000)

Variante	Art.-Nr.	CHF
	210-004-079	149.00

## DALI | Drehregler RGB(W)

DT8



B: 58 mm

H: 58 mm

T: 50.7 mm

ET: 32 mm



### Informationen

- selbstversorgt
- kompatibel mit DT8 DALI Treiber
- bis zu 50 Leuchten pro Drehregler steuerbar
- kompatibel mit Feller Modularesystem Edizio
- für einen höheren Lumenoutput ist im RGB(W)-Modus Weiss immer aktiviert
- ohne Abdeckset

Empfohlenes Zubehör von Feller

für Einbau: Abdeckset (E-Nr. 378 342 000)

für Aufbau: Abdeckset (E-Nr. 378 340 000),

Kappe mit Befestigungsbügel (E-Nr. 283 901 000)

Variante	Art.-Nr.	CHF
	210-004-089	149.00

## Zubehör

**Montageklebeband 3M**

Länge: 33 m, Dicke: 1.1 mm

Breite	Art.-Nr.	CHF
12 mm	CI-592-512-000	4.20/m
19 mm	CI-595-219-000	5.50/m

**Verbindungsklemme WAGO, 2-polig**0.08 – 4.0 mm<sup>2</sup>

Variante	Art.-Nr.	CHF
	157-812-214	0.75

**Verbindungsklemme WAGO, 3-polig**0.08 – 4.0 mm<sup>2</sup>

Variante	Art.-Nr.	CHF
	157-812-314	0.95

**Verbindungsklemme WAGO, 5-polig**0.08 – 4.0 mm<sup>2</sup>

Variante	Art.-Nr.	CHF
	157-812-514	1.40

**SMD-Leiterplattenklemme, 1-polig**0.2 – 0.75 mm<sup>2</sup>

Variante	Art.-Nr.	CHF
	WA-SMD-1P-0401	1.00

**SMD-Leiterplattenklemme, 2-polig**0.2 – 0.75 mm<sup>2</sup>

Variante	Art.-Nr.	CHF
	WA-SMD-2P-0402	1.20

**Verbindungsklemme**weiss, Polycarbonat, 3-NEZ-1-2,  
0.5 – 2.5 mm<sup>2</sup>

Variante	Art.-Nr.	CHF
	3471-000-50	4.00

**Verbindungsklemme**N-EZ-L, 16 A, 0.5 – 2.5 mm<sup>2</sup>

Variante	Art.-Nr.	CHF
	3471-000-00	3.00

**Verbindungsklemme**±, 0.5 – 2.5 mm<sup>2</sup>

Variante	Art.-Nr.	CHF
	3471-000-40	1.50

**Bandspule**Länge: 33 m, Dicke: 1.1 mm, ESD Kunststoff-  
Bandspule für 8 mm bzw. 12 mm breites  
LED-Band, VE: 10 Stk.

Breite	Art.-Nr.	CHF
9 mm	120-100-00	2.00
13 mm	120-100-01	2.50

**Kabelverbinder**Ø: 23 mm, IP68, 3-polig, 0.5 – 4.0 mm<sup>2</sup>,  
mit Wasserstop

Länge	Art.-Nr.	CHF
68 mm	30285-001-00	19.90

**Verteilerbox**

IP68, 3-polig

Variante	Art.-Nr.	CHF
	30285-000-00	29.90

**Verteilerbox**

LxBxH: 86 x 102 x 35 mm

Variante	Art.-Nr.	CHF
	290-101-00	29.90

**Verteilerbox**

LxBxH: 140 x 186 x 69 mm

Variante	Art.-Nr.	CHF
	290-102-00	49.90

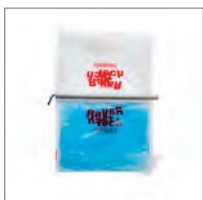
**Vergussmasse Magic Fluid**

170 ml

Variante	Art.-Nr.	CHF
	290-103-00	39.90

**Klebe-Dichtstoff**

Silikon, transparent, 90 ml

Variante	Art.-Nr.	CHF
	25958-120-07	21.00

**Kabel**

2 x 0.75 mm<sup>2</sup> (Rot: Plus, Schwarz: Minus),  
halogenfrei, weiss

Variante	Art.-Nr.	CHF
	290-900-300	3.00

**Kabel**

2 x 0.75 mm<sup>2</sup>, schwarz

Variante	Art.-Nr.	CHF
	290-900-251	4.50

**Netz Kabel (Tdf)**

weiss, mit Stecker Typ 12, 3 x 1 mm<sup>2</sup>

Länge	Art.-Nr.	CHF
2000 mm	EM-119-016-109	10.60

**Netz Kabel**

weiss, 230 V ac Einspeisung, mit Schalter und  
Netzstecker, 230 V, 2 x 0.75 mm<sup>2</sup>, max. 2.5 A

Länge	Art.-Nr.	CHF
1500 mm	23294-105-89	9.00

**Connector Kit**

IP20, Drähte 0.5 mm<sup>2</sup>, max. 5 A, 12 – 24 V dc

Variante	Art.-Nr.	CHF
2-polig	290-012-001	3.90

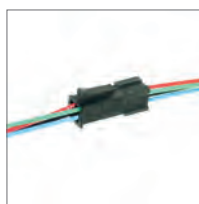
**Connector Kit**

IP20, Drähte 0.5 mm<sup>2</sup>, max. 5 A, 12 – 24 V dc

Variante	Art.-Nr.	CHF
4-polig	290-012-002	6.00

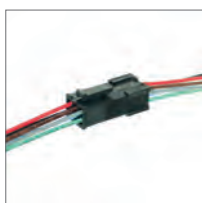
**Connector Kit**

IP20, Drähte 0.5 mm<sup>2</sup>, max. 5 A, 12 – 24 V dc

Variante	Art.-Nr.	CHF
6-polig	290-012-003	7.50

**Connector Kit**

schwarz, Konstantstrom Stecker/Kupplung je  
300 mm

Variante	Art.-Nr.	CHF
	RI-111-909-99	2.50

**Verteiler, 6-fach**

weiss, mit 1 m Kabel, max. 3 A, 6 – 24 V dc

Variante	Art.-Nr.	CHF
	23294-105-99	6.00

**Verlängerungskabel**

weiss, mit Stecker/Kupplung, max. 3 A,  
12V/24 V dc

Länge	Art.-Nr.	CHF
2000 mm	OP-9907799	3.00

**Kabel**

transparent, 2 x 0.75 mm<sup>2</sup>

Variante	Art.-Nr.	CHF
	290-900-210	12.00/m

**Kabel**

transparent, 5 x 0.75 mm<sup>2</sup>

Variante	Art.-Nr.	CHF
	290-900-510	7.50

**Seilabhängung**

Ø 1.55 mm, Stromführung im Seil integriert,  
inkl. Deckenbefestiger

Länge	Art.-Nr.	CHF
2500 mm	290-001-01	29.90

**Mustersack**

enthält Alu-Profile mit Diffusoren

Variante	Art.-Nr.	CHF
	M-990-2	auf Anfrage



# Allgemeine Geschäftsbedingungen

## Stand Juni 2022

### 1 Allgemeines

- 1.1 Die rechtlichen Beziehungen zwischen der unex lighting AG und dem Besteller bzw. Käufer (nachfolgend „Kunde“) richten sich in erster Linie nach den im Einzelfall getroffenen schriftlichen Vereinbarungen. Soweit keine abweichenden Individualabreden getroffen wurden, bilden die vorliegenden Allgemeinen Geschäftsbedingungen (AGB) die ausschliessliche Grundlage für sämtliche zwischen der unex lighting AG und dem Kunden abgewickelten Geschäfte. Anderlautende Geschäfts- oder Einkaufsbedingungen des Kunden oder Dritter sind deshalb nur dann gültig, wenn und soweit sie von der unex lighting AG ausdrücklich und schriftlich anerkannt werden. Dem Hinweis eines Kunden auf eigene Geschäftsbedingungen widerspricht die unex lighting AG hiermit ausdrücklich. Sollte der Kunde mit dieser Regelung nicht einverstanden sein, muss er die unex lighting AG unverzüglich schriftlich davon in Kenntnis setzen. Für den Fall eines schriftlichen Widerspruchs behält sich die unex lighting AG vor, ihre Angebote und Lieferungen ersatzlos zurückzuziehen, ohne dass der Kunde daraus Ansprüche irgendwelcher Art ableiten kann.
- 1.2 Ein Vertrag kommt zustande, wenn die Bestellung des Kunden durch die unex lighting AG schriftlich, per Telefax oder auf elektronischem Weg akzeptiert worden ist (Auftragsbestätigung). Die unex lighting AG ist frei, Bestellungen ohne Begründung abzulehnen.
- 1.3 Sollten einzelne der vorliegenden Bestimmungen ungültig sein oder ungültig werden, so wird dadurch die Gültigkeit der übrigen Vertragsbestimmungen nicht berührt. In einem solchen Falle ist die ungültige Bestimmung in dem Sinne umzudeuten oder zu ergänzen, dass der mit ihr beabsichtigte wirtschaftliche oder rechtliche Zweck erreicht wird.
- 1.4 Die vorliegende Version der AGB ersetzt sämtliche früheren Versionen.

### 2 Technische Vorschriften

- 2.1 Mangels abweichender Vereinbarung entsprechen die Produkte der unex lighting AG den zum Zeitpunkt der Lieferung in der Schweiz gültigen technischen Vorschriften.
- 2.2 Der Kunde hat sicherzustellen, dass die am Einsatzort massgebenden technischen Vorschriften eingehalten werden. Soweit diese von den schweizerischen Vorschriften abweichen, hat der Kunde bei der Bestellung die notwendigen Modifikationen schriftlich und detailliert zu verlangen.

### 3 Lieferbedingungen

- 3.1 Mangels abweichender Vereinbarung gelten Lieferfristen und Liefertermine als ungefähre Angaben. Sie beziehen sich auf die Bereitstellung der bestellten Produkte im Werk der unex lighting AG in Zürich.
- 3.2 Lieferfristen beginnen mit Vertragsabschluss (Ziff. 1.2) und sobald allfällige Vorauszahlungen oder Sicherheiten geleistet wurden, sämtliche technischen Fragen geklärt sind und allfällige behördliche Genehmigungen vorliegen.
- 3.3 Lieferfristen verlängern sich angemessen, wenn der Kunde seine Mitwirkungs- oder Zahlungsverpflichtungen nicht oder verspätet erfüllt oder wenn Verzögerungen durch höhere Gewalt, behördliche Massnahmen, Betriebsstörungen, Maschinendefekte oder wegen verspäteter bzw. fehlerhafter Zulieferung von Rohwaren, Halb- oder Fertigfabrikaten eintreten.
- 3.4 Falls der Kunde mit einer Vorauszahlung oder der Zahlung aus einer früheren Lieferung im Rückstand ist, ist die unex lighting AG ohne weiteres berechtigt, mit der Ausführung neuer Bestellungen zuzuwarten oder diese ganz oder teilweise zurückzuhalten, bis alle Zahlungsrückstände beglichen sind.
- 3.5 Wird ein bestimmter Liefertermin vereinbart, gelten die Ziffern 3.2 bis 3.4 analog.
- 3.6 Wegen verspäteter Lieferung stehen dem Kunden weder ein Rücktrittsrecht noch irgendwelche Minderungs- oder Schadenersatzansprüche (weder für direkte noch indirekte Schäden) zu. Jegliche Haftung der unex lighting AG sowie deren Hilfspersonen sind soweit gesetzlich zulässig wegbedungen.
- 3.7 Die unex lighting AG ist berechtigt, Teillieferungen zu erbringen. Sie trägt die dadurch allenfalls entstehenden Mehrkosten der Logistik, sofern diese Teillieferungen nicht wegen mangelnder Mitwirkung oder Zahlungsrückständen des Kunden oder auf dessen Wunsch erfolgen.
- 3.8 Nutzen und Gefahr gehen auf den Kunden über, sobald die Lieferung bzw. Teillieferung im Werk der unex lighting AG zur Abholung durch den Kunden bzw. dessen Frachtführer bereitsteht und dem Kunden dieser Termin mitgeteilt worden ist.

### 4 Preise und Zahlungsbedingungen

- 4.1 Bei den in den Katalogen, Preislisten, der Website oder im online Shop der unex lighting AG aufgeführten Preisen handelt es sich um Richtpreise, die als solche nicht verbindlich sind. Preis-, Sortiments- und Produktänderungen bleiben jederzeit vorbehalten. Bestellungen, auch im Online-Bestellsystem, Aufträge und „Auftragsbestätigungen“ des KUNDEN gelten als blosser Offerte zum VERTRAGSSCHLUSS
- 4.2 Verbindlich sind erst die in einer konkreten Offerte oder in der Auftragsbestätigung genannten Preise. Sofern in der Offerte oder im Begleitschreiben nicht anders geregelt, sind Offerten längstens 3 Monate ab Ausstellungsdatum gültig. Bestellt der Kunde geringere Stückzahlen als offeriert, bleiben Minderungen- oder sonstige Zuschläge vorbehalten.
- 4.3 Alle Preise der unex lighting AG verstehen sich netto (exkl. MWST) ab Werk der unex lighting AG in Zürich, Schweiz („Ex Works“, gemäss Incoterms 2010).
- 4.4 Sämtliche Kosten für Verpackung, Transport, Versicherungen, öffentliche Abgaben und Gebühren (z.B. Mehrwertsteuer, Zölle, Ausfuhr-, Durchfuhr und andere Bewilligungen etc.) sind nicht in den Preisen inbegriffen und gehen zu Lasten des Kunden. Soweit die unex lighting AG diese Kosten vorschiesst, sind sie ihr vom Kunden zu erstatten.

- 4.5 Auf Leuchten und Leuchtmittel werden vorgezogene Recycling Gebühren (vRG) erhoben. Für Leuchten gelten verschiedene Tarifstufen, Leuchtmittel sind mit einem einheitlichen Tarif belegt. Diese Tarife gelten in der gesamten Schweiz einheitlich und unterliegen der vom SECO (Staatssekretariat für Wirtschaft) veröffentlichten Verordnung über die Bekanntgabe von Preisen (PVB). Die Tarife und Gerätelisten sind bei der Stiftung Licht Recycling Schweiz SLRS erhältlich bzw. unter [www.slr.ch](http://www.slr.ch) einzusehen.
- 4.6 Sofern nichts anderes vereinbart wird, sind Rechnungen sofort fällig und durch den Kunden ohne jeden Abzug zu bezahlen. Die unex lighting AG behält sich vor, ganze oder teilweise Vorauszahlung zu verlangen. Für Privatkunden gilt Vorauskasse oder PayPal Bezahlung.
- 4.7 Die Zahlungstermine sind auch einzuhalten, wenn Übergabe, Transport, Abnahme oder Installation der Lieferung aus nicht von der unex lighting AG zu vertretenden Gründen verzögert oder verunmöglicht werden. Dasselbe gilt, wenn einzelne Produkte fehlen oder mangelhaft sind.
- 4.8 Hat ein Kunde mehrere offene Rechnungen, so ist die unex lighting AG berechtigt, Zahlungen auch bei gegenteiliger Anweisung des Kunden auf die älteste(n) offene(n) Rechnung(en) anzurechnen.
- 4.9 Der Kunde anerkennt, dass eine Verrechnung von Vorauszahlungen oder Zahlungen für Lieferungen mit allfälligen Forderungen des Kunden gegenüber der unex lighting AG ausgeschlossen ist. Ausgenommen sind Forderungen des Kunden, die von der unex lighting AG ausdrücklich schriftlich zur Verrechnung anerkannt oder die durch ein Gericht rechtskräftig festgestellt wurden.
- 4.10 Auf verspäteten Zahlungen hat der Kunde auch ohne vorherige Mahnung einen Verzugszins von 8% p.a. zu bezahlen. Die unex lighting AG ist bei Zahlungsverzug des KUNDEN berechtigt, das Inkasso auf Kosten des Kunden durch einen Dritten besorgen zu lassen. Allfällige Beanstandungen von Rechnungen sind innerhalb von 14 Kalendertagen ab Rechnungseingang schriftlich anzubringen, andernfalls gelten Rechnungen als anerkannt.
- 4.11 Die unex lighting AG bleibt bis zur vollständigen Bezahlung (inkl. allfällige Nebenkosten und Verzugszinsen) Eigentümerin der gesamten Lieferung. Der Käufer darf über die mit dem Eigentumsvorbehalt belastete Ware nicht verfügen. Bei Zugriffen Dritter, insbesondere Gerichtsvollzieher, auf die Vorbehaltsware muss der Käufer auf das Eigentum der unex lighting AG hinweisen und diese unverzüglich benachrichtigen.

### 5 Rücksendungen

- 5.1 Musterücksendungen können ohne Voranmeldung, sonstige Warenrücksendungen werden nur nach Voranmeldung und unter Verwendung unseres Retouren-Formulars angenommen.
- 5.2 Es werden nur originalverpackte Katalogprodukte zurückgenommen.
- 5.3 In jedem Fall werden Leuchten verrechnet, die vom Empfänger abgeändert oder beschädigt wurden (z.B. Ausbrechen oder Abändern von vorgestanzten Zuführungen, Anschlusskabel entfernt u.ä.).
- 5.4 Alle Retouren und Muster unterliegen den Abzügen gem. aktueller Bewertungstabelle. Die Abzüge werden auf der Basis des Nettowarenwertes berechnet.
- 5.5 Retourenmaterial, welches ohne Voranmeldung bzw. ohne Retouren-Auftragsbeleg eintrifft und nicht den Bedingungen gemäss aktueller Tabelle entspricht, kann leider nicht bearbeitet werden und wird entweder unfranko zurückgeschickt, ohne Vergütung eingelagert oder zu Lasten des Absenders umweltgerecht entsorgt.
- 5.6 Nicht-Katalog Artikel, die kundenspezifisch beschafft wurden, sind vom Umtausch ausgeschlossen. Die Kosten für Rücksendungen werden verursachergerecht abgerechnet.

### 6 Mängelrüge, Garantie

- 6.1 Die Produkte sind vom Kunden sofort nach Eingang sorgfältig auf Vollständigkeit (Stückzahl), Richtigkeit (Typen) und auf mögliche Mängel zu untersuchen. Sendungen mit allfälligen Transportschäden sind unter Vorbehalt anzunehmen und dem zuständigen Frachtführer umgehend zwecks Sachverhaltsabklärung und Wahrung aller Rechte anzuzeigen.
- 6.2 Allfällige Fehlmengen, Falschliefungen und/oder Mängel der gelieferten Produkte sind der unex lighting AG unverzüglich, spätestens jedoch 5 Kalendertage nach Übergabe der Produkte an den Kunden bzw. dessen Frachtführer im Werk der unex lighting AG, schriftlich und unter genauer Bezeichnung der festgestellten Unstimmigkeiten bzw. Mängel mitzuteilen. Nach unbenutztem Ablauf dieser Frist (massgebend ist das Eingehen der Mängelrüge bei der unex lighting AG) gilt die Lieferung mit Bezug auf Fehlmengen, Falschliefungen sowie offene Mängel als genehmigt.
- 6.3 unex lighting AG steht für Service und Qualität. Dies unterstreichen wir mit der Gewährung einer 5-Jahre-Herstellergarantie auf Unex-Produkte nach Massgabe der nachfolgenden Bestimmungen: Wir garantieren, unabhängig von der gesetzlichen Gewährleistung, dass unsere Produkte während des Garantiezeitraums von 5 Jahren frei sind von Material-, Konstruktions- oder Produktionsfehlern. Die Garantie gilt ab dem Zeitpunkt, in dem die Lieferung bzw. Teillieferung im Werk der unex lighting AG zur Abholung durch den Kunden bzw. dessen Frachtführer bereitsteht und dem Kunden dieser Termin mitgeteilt worden ist, bei bestimmungsgemäsem Gebrauch der Produkte innerhalb der Produktspezifikationen. Von diesen 5 Jahren ausgenommen sind folgende Produkte, Komponenten oder Sachverhalte:
  - Ware die vom Käufer oder dessen Kunden weiterverarbeitet / verändert wurde
  - Lose gelieferte LED Stripes: 2 Jahre Garantie
  - Halbfertigprodukte (z.B. teilkonfektionierte Lösungen)
  - Aussenleuchten und Leuchten in Aussenanwendungen: 2 Jahre Garantie
  - Nex Flex: 3 Jahre Garantie
  - Leuchtmittel mit GU10 Fassungen: Unex Ridl 7 haben 3 Jahre, Unex Lamp GU10 haben 2 Jahre
  - Batterien/Akkus in Leuchten oder lose geliefert: 1 Jahr Garantie

- Bewegungsmelder/Leuchten mit Bewegungsmelder: 2 Jahre Garantie
- Schäden, die die Funktion des Produkts nicht beeinträchtigen, z.B. Kratzer, Risse, Dellen, Beulen, Lackierung, dekorative Ausstattung, etc.,
- Schäden aufgrund von Bedingungen der Stromversorgung, einschliesslich kurzzeitigen Spannungsspitzen, Über-/ Unterspannung,
- Schäden, welche auf Softwarefehler, Bugs, Viren oder Ähnliches zurückzuführen sind,
- Schäden aufgrund höherer Gewalt,
- Komponenten und Teile, die dem Verschleiss oder der natürlichen Alterung unterliegen, wie z.B. Dichtungen, Kunststoffteile, Anschlussleitungen, etc.,

Jede weitere Garantieleistung oder Schadenersatzleistung ist ausgeschlossen. Insbesondere werden keine Kosten für die Programmierung, Transport, Demontage und Wiedermontage von Leuchten und Apparaten oder deren Bestandteile sowie für irgendwelche andere Folgeschäden übernommen. Garantieleistungen bewirken weder eine Verlängerung der Garantiefrist noch setzen sie eine neue Garantiefrist in Lauf. Die Garantiefrist für instand gesetzte / getauschte Teile oder Ersatzlieferungen endet mit der Garantiefrist für das gesamte Produkt. Voraussetzung für einen Garantieanspruch ist, dass die Leuchtmittel / Strips und Leuchten mit den von Unex spezifizierten, geprüften und gelieferten Betriebsgeräten betrieben wurden. Der Lieferant setzt den Besteller davon in Kenntnis, dass die zur Durchführung des kaufmännischen Geschäftsablaufes erforderlichen Daten des Bestellers gespeichert werden. Abweichungen vom ursprünglichen Produkt aufgrund technischen Fortschritts sowie vertretbare Abweichungen hinsichtlich Design und Eigenschaften sind vorbehalten.

- 6.4 Allfällige verdeckte Mängel sind der unex lighting AG innert der Garantiefrist innert 5 Tagen nach Feststellung schriftlich und detailliert mitzuteilen. Auf Verlangen hat der Kunde der unex lighting AG das defekte Produkt zur Verfügung zu stellen. Die Garantie erstreckt sich auf Mängel, die nachweisbar auf eine fehlerhafte Fabrikation, mangelhaftes Material oder das Nichteinhalten der massgebenden bzw. vereinbarten technischen Vorschriften (vorangehend Ziff. 2) zurückzuführen sind.
- 6.5 Von der Garantie ausgeschlossen sind Nicht- oder Fehlfunktionen, die auf nicht bestimmungsgemässen Gebrauch, unsachgemässe Behandlung oder Lagerung, auf Missachtung von Installations- oder Betriebsvorschriften, auf Manipulationen am Produkt, mangelhafte Wartung, Überlastung oder sonstige übermässige Beanspruchung, schädliche Witterungs- und sonstige Umwelteinflüsse, chemische, elektrolytische oder elektromagnetische Einflüsse sowie auf Interferenzen mit anderen Produkten zurückzuführen sind. Im Garantiefall wird nach Wahl der unex lighting AG entweder das defekte Produkt, Teile davon ersetzt oder dem Kunden eine Preisminderung gewährt. Jegliche weitergehende Haftung der unex lighting AG oder deren Hilfspersonen sind wegbedungen, soweit dies gesetzlich zulässig ist. Insbesondere bestehen keinerlei Ansprüche des Kunden oder Dritter auf Ersatz von Schäden, die nicht am gelieferten Produkt selbst entstanden sind, wie Programmierung, Montage-, Installationskosten, Produktionsausfall, Nutzungsverluste, entgangener Gewinn oder andere direkte oder indirekte Schäden und Mangelfolgeschäden, namentlich unmittelbare sowie mittelbare Schäden Dritter, die durch Fehl- oder Nichtfunktion der gelieferten Produkte verursacht wurden, etc. Ebenso besteht keine Garantie für Material, an dem vom KUNDEN oder von Dritten Änderungen oder Reparaturen vorgenommen oder für das die Montage- oder Betriebsvorschriften des Lieferanten nicht eingehalten wurden. Von der Garantie ausgeschlossen sind auch Leuchten und Apparate, welche nach Konstruktionen oder Modellen des KUNDEN hergestellt werden, sofern auftretende Schäden auf Konstruktionsfehler zurückzuführen sind. Wird zudem für solches Material vom Starkstrominspektorat eine Prüfung oder eine Abänderung verlangt, gehen alle hieraus resultierenden Kosten zu Lasten des KUNDEN. Mit der Ausnahme von Preisminderungen setzt jegliche Garantie voraus, dass das defekte Material verpackt und franko unex lighting AG zugestellt wird. Folgende Informationen zur Lebensdauer von Leuchten sind zu beachten: Die Lebensdauer aller lichttechnischen Produkte ist von der Einhaltung der in den technischen Daten angegebenen Standard-Betriebsbedingungen abhängig. Leuchten sind Verschleissteile, deren jeweilige Lebensdauer sehr unterschiedlich ist (1'000 bis 60'000 Stunden) und von den Betriebsbedingungen stark beeinflusst werden kann. Die Angabe der Lebensdauer einer Leuchte geschieht in Form von Betriebsstunden (z. B. mittlere Lebensdauer = 50'000 Stunden) und wird unter genormten Bedingungen ermittelt, die von der Praxis abweichen können. Wird die Lebensdauer in Form von Betriebsjahren angegeben, basiert dies ebenfalls ausschliesslich auf angenommenen Standard-Betriebsbedingungen (Schaltzyklen, Betriebsstunden pro Jahr usw.) und den üblichen Kriterien für Wartungsintervalle, die für den angesprochenen Einsatzzweck sinnvoll erscheinen. Grenzwerte für Temperaturen, Umgebungstemperatur 25°C und Spannungen dürfen nicht überschritten werden, das Produkt darf keinen nicht bestimmungsgemässen mechanischen oder anderen Belastungen ausgesetzt sein. Der Lichtstromrückgang bei LED Lichtquellen ist bis zu einem Wert von 0,6 % pro 1000 h Betriebsstunden normal und somit nicht von der Garantie erfasst. Bei elektronischen Betriebsgeräten bzw. Bauteilen wie LED-Modulen beträgt die mittlere Nennausfallsrate 0,2%/1000 Betriebsstunden, sofern die mittlere Nennlebensdauer und Nennausfallsrate der Geräte oder Bauteile in den Produkt- und Anwendungsspezifikationen (insbesondere gemäss Katalog, Datenblatt, Produktbroschüre und dergleichen) nicht anders definiert sind. Diese gilt unter den unten angeführten Bedingungen. Jegliche Garantie setzt voraus, dass das defekte Material der Firma unex lighting AG verpackt franko Domizil zugestellt wird. Die Garantie umfasst ausschliesslich Produktausfälle die durch nachgewiesene Material-, Konstruktions- oder Produktionsfehler verursacht wurden, sowie Ausfallraten, die die Nennausfallrate übersteigen. Die unex lighting AG behält sich vor, über die Berechtigung des Garantieanspruchs nach Produktprüfung selbst zu entscheiden. Die Garantie erlischt sofort, wenn an den Produkten ohne vorherige schriftliche Einwilligung durch den Garanten Änderungen, Reparaturen, Servicearbeiten oder Störungsbehebungen durch den Kunden oder Dritte vorgenommen werden. Die Farbtoleranz von

LED-Modulen ist von der Herstellergarantie nicht umfasst. Der Lichtstrom und die Leistung unterliegen bei einem neuem LED-Modul / Lichtquelle einer Toleranz von +/- 10%. Bei Nachlieferungen von LED Modulen / Lichtquellen / Leuchten kann es auf Grund des technischen Fortschritts sowie der nutzungsbedingten Veränderung des Lichtstroms und der Lichtfarbe von Produkten zu Abweichungen in den Lichteigenschaften gegenüber den Ursprungsprodukten kommen. Vereinbarte Haftungsbegrenzungen gelten für den Garantieanspruch entsprechend.

- 6.6 Falls der Kunde Produkte beanstandet, die sich als mängelfrei herausstellen, kann dem Kunden der Prüfaufwand der unex lighting AG in Rechnung gestellt werden.

## 7 Planung und Beratung durch unex lighting AG

- 7.1 Soweit die unex lighting AG für den Kunden Beleuchtungskonzepte erarbeitet oder ihn diesbezüglich berät, handelt es sich um Gefälligkeitsleistungen, für welche die unex lighting AG keinerlei Haftung übernimmt. Davon ausgenommen ist das Einhalten konkreter messbarer Vorgaben (z.B. Beleuchtungsstärke), sofern die unex lighting AG im Einzelfall schriftlich eine entsprechende Haftung übernimmt.

## 8 Vom Kunden gewünschte Reparaturen

- 8.1 Falls der Kunde ausserhalb der geltenden Garantiebestimmungen Produkte durch die unex lighting AG reparieren lässt, trägt er die entsprechenden Kosten, insbesondere für Aufwand, Material und Transport.
- 8.2 Wünscht der Kunde für solche Reparaturen einen Kostenvorschlag, hat er dies unex lighting AG im Voraus mitzuteilen. Der Kunde trägt die Kosten des Kostenvorschlags unabhängig davon, ob die Reparatur vorgenommen wird oder nicht.

## 9 Besondere Pflichten des Kunden

- 9.1 Die Produkte dürfen nur durch ausgebildete Starkstrom-Fachleute (Elektriker) montiert/demontriert und gewartet werden. Achtung: Starkstrom bedeutet Lebensgefahr!
- 9.2 Der Kunde ist verpflichtet, alle generellen sowie die massgebenden örtlichen Vorschriften für die Montage/Demontage, den Betrieb und die Wartung der Produkte zu beachten und einzuhalten. Zudem ist der Kunde verpflichtet, die produktbezogenen Montage-, Bedienungs- und Wartungsanleitungen der unex lighting AG zu beachten und einzuhalten.
- 9.3 Falls der Kunde Produkte der unex lighting AG an Dritte liefert oder durch Dritte installieren lässt, hat er diese Dritten schriftlich zur Einhaltung der Vorschriften gemäss den vorangehenden Ziffern 8.1 und 8.2 zu verpflichten und dafür zu sorgen, dass die Montage-, Bedienungs- und Wartungsanleitungen den Dritten in einer für diese verständlichen Sprache zur Verfügung gestellt werden. Ausserdem sind diese Dritten schriftlich zu verpflichten, die Pflicht gemäss dieser Ziffer 8.3 auf allfällige weitere Abnehmer zu übertragen.
- 9.4 Wird ein Personen-, Sach- oder Vermögensschaden durch Handlungen und/oder Unterlassungen des Kunden oder einer seiner Hilfspersonen oder seiner Abnehmer oder Unterabnehmer etc. verursacht und aus diesem Grund die unex lighting AG in Anspruch genommen, steht dieser ein Rückgriffsrecht auf den Kunden zu. Dieser hat die unex lighting AG auf erstes Verlangen vollumfänglich schadlos zu halten und ihr auch die Kosten für die Abwehr der Inanspruchnahme zu ersetzen.

## 10 Geistiges Eigentum

- 10.1 Das geistige Eigentum an sämtlichen Produkten (inkl. Know-how) gehört ausschliesslich der unex lighting AG bzw. deren Lieferanten, die alleine berechtigt sind, gegebenenfalls gewerbliche Schutzrechte (Patente, Designs, Topographien etc.) zu registrieren. Sämtliche Urheberrechte an Soft- bzw. Firmware, Kostenvorschlägen, technischen Zeichnungen, der Gestaltung der Produkte, an Montage-, Bedienungs- und Wartungsanleitungen sowie an sonstigen Unterlagen stehen uneingeschränkt der unex lighting AG bzw. deren Lieferanten zu.
- 10.2 Sofern nicht ausdrücklich und schriftlich etwas Abweichendes vereinbart wird, gilt diese Regelung auch dann, wenn die unex lighting AG kundenspezifische Anpassungen, Vorschläge, Projektskizzen oder Entwicklungen vornimmt. Solche Unterlagen und Dokumente der unex lighting AG dürfen ohne deren ausdrückliche Genehmigung weder ganz noch auszugsweise vervielfältigt oder Dritten zugänglich gemacht werden.
- 10.3 Soweit der Kunde der unex lighting AG Unterlagen/Daten (Zeichnungen, Pläne, Masse, Muster etc.) zustellt, sichert er zu, dass diese Unterlagen/Daten frei von Schutzrechten Dritter sind und im Rahmen des jeweiligen Projekts durch die unex lighting AG benützt und gegebenenfalls bearbeitet werden dürfen.

## 11 Anwendbares Recht, Erfüllungsort, Gerichtsstand

- 11.1 Sämtliche Rechtsverhältnisse zwischen der unex lighting AG und dem Kunden unterstehen schweizerischem materiellem Recht, unter Ausschluss des Übereinkommens der Vereinten Nationen über Verträge über den internationalen Warenkauf vom 11. April 1980.
- 11.2 Die unex lighting AG behält sich eine jederzeitige Änderung dieser AGB vor. Änderungen gelten ab deren Mitteilung an den KUNDEN für alle danach begründeten Rechtsbeziehungen zwischen der unex lighting AG und dem KUNDEN.
- Sollten eine oder mehrere Bestimmungen dieser AGB ungültig oder unwirksam sein, so hat dies keinen Einfluss auf die Wirksamkeit der übrigen Bestimmungen und dieser AGB insgesamt.
- 11.3 Erfüllungsort für alle Leistungen ist der schweizerische Sitz der unex lighting AG.
- 11.4 Für alle Streitigkeiten zwischen dem Kunden und der unex lighting AG sind ausschliesslich die Gerichte am schweizerischen Sitz der unex lighting AG zuständig. Die unex lighting AG bleibt jedoch berechtigt, den Kunden an jedem anderen zulässigen Gerichtsstand zu belangen.

## Index nach Name

**A**

Asimo LED   Stehleuchte	279
Asimo LED   Wandaufbauleuchte	263
Aski   Profil-System	32

**B**

Baldachin mit LED-Treiber	275
Basic 18   Profil-System	40
Basic 30   Profil-System	54
Basic 35   Profil-System	58
Blade   Profil-System	85
Blade   Wandaufbauleuchte	267
Blade Mini   Profil-System	84
Bow   Profil-System	38
Box Asym LED   Wandeinbauleuchte	226
Box LED   Wandeinbauleuchte	227

**C**

Cilindro LED, Ø 90 mm   Aufbau-Downlight	215
Cilindro LED, Ø 118 mm   Aufbau-Downlight	215
Cilindro Outdoor LED, Ø 80 mm   Aufbau-Downlight	325
Cilindro Outdoor LED, Ø 110 mm   Aufbau-Downlight	325
Climb LED   Wandaufbauleuchte	263
Cloud LED, Ø 200 mm   Decken- und Wandaufbauleuchte	241
Cloud LED, Ø 250 mm   Decken- und Wandaufbauleuchte	241
Cloud LED, Ø 300 mm   Decken- und Wandaufbauleuchte	242
Cloud LED, Ø 350 mm   Decken- und Wandaufbauleuchte	243
Cloud LED, Ø 400 mm   Decken- und Wandaufbauleuchte	243
Combo 20   Profil-System	42
Combo 30   Profil-System	44
Concave, BL-Ø 68 mm   Deckeneinbauring	208
Concave, BL-Ø 75 mm   Deckeneinbauring	208
Concave, BL-Ø 80 mm   Deckeneinbauring	209
Coppo LED, 220 mm, 1-seitiger Lichtaustritt   Wandaufbauleuchte	352
Coppo LED, 220 mm, 2-seitiger Lichtaustritt   Wandaufbauleuchte	352
Coppo LED, 280 mm, 1-seitiger Lichtaustritt   Wandaufbauleuchte	353
Coppo LED, 280 mm, 2-seitiger Lichtaustritt   Wandaufbauleuchte	353
Corner 16   Profil-System	74
Corner 30   Profil-System	76
Crono LED   Decken- und Wandaufbauleuchte	233

**D**

Delight II LED, Ø 280 mm   Decken- und Wandaufbauleuchte	229
Delight II LED, Ø 380 mm   Decken- und Wandaufbauleuchte	229
Delight II LED, Ø 600 mm   Decken- und Wandaufbauleuchte	230
Delight II LED, Ø 900 mm   Decken- und Wandaufbauleuchte	230
Delight LED   Baldachin	231
Diamond LED, Ø 300 mm   Decken- und Wandaufbauleuchte	234
Diamond LED, Ø 350 mm   Decken- und Wandaufbauleuchte	234
Diamond LED, Ø 350 mm, E27   Decken- und Wandaufbauleuchte	235
Diamond LED, Ø 400 mm   Decken- und Wandaufbauleuchte	235
Disc, BL-Ø 68 mm   Deckeneinbauring	213
Disc, BL-Ø 68 mm, schwenkbar   Deckeneinbauring	213
Duplex   Pendelleuchte	272
Duplex   Profil-System	56

**E**

EcoLED, BL-Ø 90 – 100 mm   Einbau-Downlight	171
EcoLED, BL-Ø 125 – 132 mm   Einbau-Downlight	171
EcoLED, BL-Ø 140 – 150 mm   Einbau-Downlight	172
EcoLED, BL-Ø 172 – 200 mm   Einbau-Downlight	172
EcoLED, BL-Ø 200 – 220 mm   Einbau-Downlight	173
Edge   Profil-System	72
Evida Round II LED   Wandaufbauleuchte	347
Evida Square II LED   Wandaufbauleuchte	351
Exit LED   Rettungszeichenleuchte	307
Eye LED   Möbeleinbauleuchte	309

**F**

Flatfix Superslim II, BL-Ø 132 mm   Einbau-Downlight	168
Flatfix Superslim II, BL-Ø 160 mm   Einbau-Downlight	169
Flatfix Superslim II, BL-Ø 225 mm   Einbau-Downlight	169
Flat LED, Modul 600   Deckeneinbauleuchte	217
Flat LED, Modul 625   Deckeneinbauleuchte	217
Flat Long LED   Deckeneinbauleuchte	221
Flat Short LED   Deckeneinbauleuchte	221
Flat Tunable White LED, Modul 600   Deckeneinbauleuchte	219
Flat Tunable White LED, Modul 625   Deckeneinbauleuchte	219
Flex II   Möbelaufbauleuchte	313
Float LED   Stehleuchte	277
Flood LED, 10 W   Scheinwerfer	356
Flood LED, 20 W   Scheinwerfer	357
Flood LED, 30 W   Scheinwerfer	357

**G**

GU10   Fassung	197
----------------	-----

**L**

L8 Mini   Wandeinbauleuchte	329
L8 Rondo   Wandeinbauleuchte	328
L9 II   Wandeinbauleuchte	333
L10 Round   Bodeneinbauleuchte	366
L10 Square   Bodeneinbauleuchte	367
L11 Round   Bodeneinbauleuchte	366
L11 Square   Bodeneinbauleuchte	367
L12   Bodeneinbauleuchte	365
Lago LED, Ø 220 mm   Decken- und Wandaufbauleuchte	237
Lago LED, Ø 275 mm   Decken- und Wandaufbauleuchte	237
Lago LED, Ø 275 mm, Not-Variante   Decken- und Wandaufbauleuchte	239
Lago LED, Ø 350 mm   Decken- und Wandaufbauleuchte	239
Leezy LED   Möbelaufbauleuchte	313
Lift LED, BL-Ø 80 – 85 mm   Einbau-Downlight	167
Lim LED   Pollerleuchte	379
Lim LED   Wandaufbauleuchte	261
Lim L LED   Wandaufbauleuchte	261
Lim Outdoor Cube LED   Wandaufbauleuchte	349
Lim Outdoor LED   Wandaufbauleuchte	349
Linea 20   Profil-System	46
Linea 25   Profil-System	48
Linea 25 High   Profil-System	50
Linea 30 II   Profil-System	52
Line LED   Balkenleuchte	301
Link LED   Balkenleuchte	299
LUV Asym II   Wandeinbauleuchte	331
LUV II   Wandeinbauleuchte	330

## Index nach Name

### M

Mastro LED, 50 W   Scheinwerfer	358
Mastro LED, 100 W   Scheinwerfer	359
Mastro LED, 150 W   Scheinwerfer	359
Mini LED   Bodeneinbauleuchte	364
Mini LED   Erdspiessleuchte	369
Mira II LED, BL-Ø 68 mm   Einbau-Downlight	185
Mira II LED, BL-Ø 75 mm   Einbau-Downlight	185
Mira II LED, BL-Ø 100 mm   Einbau-Downlight	186
Mira II LED, BL-Ø 125 mm   Einbau-Downlight	186
Mira II LED, BL-Ø 150 mm   Einbau-Downlight	187
Modern II LED   Pendelleuchte	271
Modern II LED   Stromschienen-Leuchte	297
Modul 8   Decken- und Wandaufbauleuchte	250
Modul 8   Stromschienen-Leuchte	296
Modul 8 Flat   Decken- und Wandaufbauleuchte	251
Modul 8 Flat   Pendelleuchte	272
Modul 8 Round   Decken- und Wandaufbauleuchte	251
Modular   Decken- und Wandaufbauleuchte	253
Modular 18   Profil-System	60
Modular 42   Profil-System	64
Modular 60   Profil-System	68
Modular 60 Square   Pendelleuchte	273
Mood, BL-Ø 68 mm   Deckeneinbauring	210
Mood Trimless, BL-Ø 68 mm   Deckeneinbauring	211

### N

Nano LED   Erdspiessleuchte	369
Nex Flex F15 LED   Flexible Bandleuchte	112
Nex Flex F16 LED   Flexible Bandleuchte	114
Nex Flex F22 LED   Flexible Bandleuchte	116
Nex Flex F23 LED   Flexible Bandleuchte	110

### P

Philips Classic LED E27   Leuchtmittel	197
Pico LED, BL-Ø 40 mm   Einbau-Downlight	183
Pico LED, BL-Ø 68 mm   Einbau-Downlight	183
Planar   Profil-System	30
Plate Round LED   Decken- und Wandaufbauleuchte	337
Plate Square LED   Decken- und Wandaufbauleuchte	337
Polar LED, BL-Ø 80 mm   Einbau-Downlight	323
Polar LED, BL-Ø 90 – 100 mm   Einbau-Downlight	323
Proof LED   Feuchtraum-Wannenleuchte	303

### R

RIDL 7 GU10   Leuchtmittel	189
RIDL 8, Dim to Warm   Leuchtmittel	191
RIDL 8 II   Leuchtmittel	190
RIDL 8 Karda 68, BL-Ø 68 mm   Einbau-Downlight	163
RIDL 8 Karda 68, BL-Ø 68 mm, ohne Treiber   Einbau-Downlight	163
RIDL 9   Leuchtmittel	192
RIDL 9 Flat, BL-Ø 68 mm   Einbau-Downlight	159
RIDL 9 Flat, BL-Ø 68 mm, ohne Treiber   Einbau-Downlight	158
RIDL 9 Karda 68, BL-Ø 68 mm   Einbau-Downlight	164
RIDL 9 Karda 68, BL-Ø 68 mm, ohne Treiber   Einbau-Downlight	164
RIDL 9 Karda 80, BL-Ø 68 – 82 mm   Einbau-Downlight	165
RIDL 9 Karda 80, BL-Ø 68 – 82 mm, ohne Treiber   Einbau-Downlight	165
RIDL 9, Vivid   Leuchtmittel	193

RIDL 13   Leuchtmittel	194
RIDL 13 Flat, BL-Ø 75 – 82 mm   Einbau-Downlight	161
RIDL 13 Flat, BL-Ø 75 – 82 mm, ohne Treiber   Einbau-Downlight	160
RIDL 13 Tunable White   Leuchtmittel	195
RIDL Concave Big II, BL-Ø 150 mm   Einbau-Downlight	177
RIDL Flex Round Big II, BL-Ø 115 mm   Einbau-Downlight	174
RIDL Flex Square Big II, BL-125 mm   Einbau-Downlight	175
RISP 12 W, 1-Phasen   Stromschienen-Strahler	290
RISP 12 W, 3-Phasen   Stromschienen-Strahler	291
RISP 12 W One   Stromschienen-Strahler	290
RISP 19 W   Stromschienen-Strahler	291
RISP 33 W, DALI   Stromschienen-Strahler	293
RISP 33 W, Phasenabschnitt   Stromschienen-Strahler	292
RISP 43 W, 3000 K, CRI 95   Stromschienen-Strahler	295
RISP GU10   Stromschienen-Strahler	289
RISP Mini GU10, 1-Phasen   Stromschienen-Strahler	288
RISP Mini GU10, 3-Phasen   Stromschienen-Strahler	289
RISP Mini GU10 One   Stromschienen-Strahler	288

### S

Shi LED   Wandaufbauleuchte	265
Side   Decken- und Wandaufbauleuchte	255
Side Round   Decken- und Wandaufbauleuchte	255
Single LED   Decken- und Wandaufbauleuchte	257
Slick   Profil-System	28
Slight   Profil-System	36
Slim   Profil-System	26
Smart, für 1 Türe   Möbelbeleuchtungs-Set	316
Smart, für 2 Türen   Möbelbeleuchtungs-Set	316
Smart, für 3 Türen   Möbelbeleuchtungs-Set	317
Spike II, Maxi   Erdspiessleuchte	371
Spike II, Medium   Aufbauleuchte	373
Spike II, Medium   Erdspiessleuchte	371
Spike II, Mini   Erdspiessleuchte	370
Square LED   Pollerleuchte	379
Square LED   Wandaufbauleuchte	351
Storage LED   Hallenleuchte	305
Swifty LED, BL-Ø 68 – 75 mm   Einbau-Downlight	156
Swing 68 GU10, BL-Ø 68 mm   Einbau-Downlight	127
Swing 68 mit RIDL 8 II, BL-Ø 68 mm   Einbau-Downlight	129
Swing 68 mit RIDL 9, BL-Ø 68 mm   Einbau-Downlight	130
Swing 68 mit RIDL 13, BL-Ø 68 mm   Einbau-Downlight	131
Swing 68, BL-Ø 68 mm   Deckeneinbauring	200
Swing 68 Plan mit RIDL 8 II, BL-Ø 68 mm   Einbau-Downlight	133
Swing 68 Plan mit RIDL 9, BL-Ø 68 mm   Einbau-Downlight	134
Swing 68 Plan mit RIDL 13, BL-Ø 68 mm   Einbau-Downlight	135
Swing 68 Plan, BL-Ø 68 mm   Deckeneinbauring	201
Swing 68 RIDL 7, BL-Ø 68 mm   Einbau-Downlight	128
Swing 80 GU10, BL-Ø 68 – 80 mm   Einbau-Downlight	137
Swing 80 mit RIDL 8 II, BL-Ø 68 – 80 mm   Einbau-Downlight	139
Swing 80 mit RIDL 9, BL-Ø 68 – 80 mm   Einbau-Downlight	140
Swing 80 mit RIDL 13, BL-Ø 68 – 80 mm   Einbau-Downlight	141
Swing 80, BL-Ø 68 – 80 mm   Deckeneinbauring	202
Swing 80 Plan mit RIDL 8 II, BL-Ø 68 – 80 mm   Einbau-Downlight	143
Swing 80 Plan mit RIDL 9, BL-Ø 68 – 80 mm   Einbau-Downlight	144
Swing 80 Plan mit RIDL 13, BL-Ø 68 – 80 mm   Einbau-Downlight	145
Swing 80 Plan, BL-Ø 68 – 80 mm   Deckeneinbauring	203
Swing 80 RIDL 7, BL-Ø 68 – 80 mm   Einbau-Downlight	138



## Index nach Name

## T

Tablar, für 1 Türe und 1 Tablar   Tablarbeleuchtungs-Set	318
Tablar, für 2 Türe und 1 Tablar   Tablarbeleuchtungs-Set	318
Tablar, für zusätzliche Tablare   Lichtschiene	319
Takeo Round LED, BL-Ø 108 mm   Einbau-Downlight	168
Takeo Round LED, Ø 115 mm   Decken- und Wandaufbauleuchte	244
Takeo Round LED, Ø 180 mm   Decken- und Wandaufbauleuchte	244
Takeo Round LED, Ø 240 mm   Decken- und Wandaufbauleuchte	245
Takeo Round LED, Ø 300 mm   Decken- und Wandaufbauleuchte	245
Takeo Square LED, □ 108 mm   Decken- und Wandaufbauleuchte	246
Takeo Square LED, □ 168 mm   Decken- und Wandaufbauleuchte	246
Takeo Square LED, □ 220 mm   Decken- und Wandaufbauleuchte	247
Takeo Square LED, □ 300 mm   Decken- und Wandaufbauleuchte	247
Tek 1   Profil-System	70
Tek 2   Profil-System	71
Tera II 1XGU10 LED   Wandaufbauleuchte	343
Tera II 2XGU10 LED   Wandaufbauleuchte	343
Tera II LED, Ø 80 mm   Wandaufbauleuchte	345
Tera II LED, Ø 110 mm   Wandaufbauleuchte	345
Tom Round II LED   Wandaufbauleuchte	347
Tom Round II LED, 265 mm   Pollerleuchte	375
Tom Round II LED, 800 mm   Pollerleuchte	374
Tom Round II LED, 1100 mm   Pollerleuchte	374
Tom Square II LED, 265 mm   Pollerleuchte	377
Tom Square II LED, 800 mm   Pollerleuchte	376
Tom Square II LED, 1100 mm   Pollerleuchte	376
Trina LED   Wandaufbauleuchte	265
Tube 16   Profil-System	78
Tube 26   Profil-System	80
Tube 35   Pendelleuchte	273
Tube 35   Profil-System	82
Tube 60   Profil-System	83
Tura LED, Ø 180 mm   Decken- und Wandaufbauleuchte	334
Tura LED, Ø 235 mm   Decken- und Wandaufbauleuchte	334
Tura LED, Ø 290 mm   Decken- und Wandaufbauleuchte	335
Tura Square LED   Decken- und Wandaufbauleuchte	335
Turn LED   Wandaufbauleuchte	355
Twin LED   Decken- und Wandaufbauleuchte	257
Twist 2X Square Plan, DA 164 x 80 mm   Deckeneinbauring	207
Twist 2X Square Plan mit RIDL 9, DA 164 x 80 mm   Einbau-Downlight	155
Twist 80 Plan mit RIDL 8 II, BL-Ø 80 mm   Einbau-Downlight	147
Twist 80 Plan mit RIDL 9, BL-Ø 80 mm   Einbau-Downlight	148
Twist 80 Plan mit RIDL 13, BL-Ø 80 mm   Einbau-Downlight	149
Twist 80 Plan, BL-Ø 80 mm   Deckeneinbauring	204
Twist 80 Plan RIDL 7, BL-Ø 80 mm   Einbau-Downlight	146
Twist 80 Square Plan mit RIDL 8 II, BL-Ø 80 mm   Einbau-Downlight	151
Twist 80 Square Plan mit RIDL 9, BL-Ø 80 mm   Einbau-Downlight	152
Twist 80 Square Plan mit RIDL 13, BL-Ø 80 mm   Einbau-Downlight	153
Twist 80 Square Plan, BL-Ø 80 mm   Deckeneinbauring	205
Twist 80 Square Plan RIDL 7, BL-Ø 80 mm   Einbau-Downlight	150
Twist 100 Plan mit RIDL 9, BL-Ø 90 – 100 mm   Einbau-Downlight	155
Twist 100 Plan, BL-Ø 90 – 100 mm   Deckeneinbauring	206
Twist Round GU10   Aufbau-Downlight	214
Twist Square GU10   Aufbau-Downlight	214

## U

Unex   Stromschienen-System	284
Unex Flex, 5 m   LED-Band	90
Unex Flex, 10 m   LED-Band	90
Unex Flex 210   LED-Band	94
Unex Flex Back   LED-Band	88
Unex Flex COB   LED-Band	98
Unex Flex COB Tunable White   LED-Band	98
Unex Flex Dim to Warm   LED-Band	99
Unex Flex Efficiency Plus, 13 W/m   LED-Band	95
Unex Flex Efficiency Plus, 18.5 W/m   LED-Band	95
Unex Flex High Efficiency   LED-Band	94
Unex Flex High Output   LED-Band	97
Unex Flex High-Power, 5 m   LED-Band	92
Unex Flex High-Power, 10 m   LED-Band	92
Unex Flex High-Power IP65   LED-Band	93
Unex Flex IP65   LED-Band	91
Unex Flex RGB   LED-Band	100
Unex Flex RGB IP65   LED-Band	100
Unex Flex Slim   LED-Band	89
Unex Flex Top   LED-Band	101
Unex Flex Tunable White   LED-Band	99
Unex Lamp E27   Leuchtmittel	196
Unex Lamp GU10   Leuchtmittel	196
Unex One   Stromschienen-System	282
Unex Rigid   LED-Platine	103

## V

Vario LED, BL-Ø 58 mm   Einbau-Downlight	157
Vario LED, BL-Ø 68 mm, schwenkbar   Einbau-Downlight	157
Venus Round LED   Aufbau-Downlight	327
Venus Square LED   Aufbau-Downlight	327
Via LED   Bodeneinbauleuchte	362
Via One LED   Bodeneinbauleuchte	362
Via Three LED   Bodeneinbauleuchte	363
Via Two LED   Bodeneinbauleuchte	363

## X

X LED   Wandeinbauleuchte	225
---------------------------	-----

## Z

Zaky LED   Decken- und Wandaufbauleuchte	341
Zaky LED, Sensor   Decken- und Wandaufbauleuchte	341
Zaky Mono LED   Decken- und Wandaufbauleuchte	340
Zaky Mono LED, Sensor   Decken- und Wandaufbauleuchte	340
Zenta II LED, BL-Ø 68 mm   Einbau-Downlight	179
Zenta II LED, BL-Ø 90 mm   Einbau-Downlight	179
Zenta II LED, BL-Ø 125 mm   Einbau-Downlight	180
Zenta II LED, BL-Ø 150 mm   Einbau-Downlight	180
Zenta II LED, BL-Ø 190 – 220 mm   Einbau-Downlight	181
Zenta II Tunable White LED, BL-Ø 150 mm   Einbau-Downlight	181

## Index nach Artikelnummer

043-001-012	403	110-003-02	318	120-006-85	116	130-220-50	210	130-844-70	192	141-003-200	284
043-001-025	403	110-003-10	319	120-006-86	116	130-220-51	210	130-845-70	193	141-003-300	284
043-001-045	404	110-004-01	318	120-006-88	116	130-220-52	210	130-850-20	190	141-003-400	284
043-002-025	404	110-004-02	318	120-006-89	116	130-220-53	210	130-850-70	190	141-004-101	284
043-024-020	387	110-004-10	319	120-006-90	116	130-220-54	210	130-851-20	190	141-004-201	284
043-024-021	387	110-005-01	318	120-006-91	116	130-220-60	210	130-851-40	190	141-004-301	284
043-024-031	387	110-005-02	318	120-006-92	116	130-220-61	210	130-851-70	190	141-004-401	284
043-024-032	388	110-005-10	319	120-006-93	116	130-220-62	210	130-890-90	189, 190, 191, 192, 194	141-005-000	285
043-024-034	388	110-006-01	318	120-006-94	117	130-220-63	210	130-890-91	189, 190, 191, 192, 194	141-005-001	285
043-024-076	389	110-006-02	318	120-006-96	116	130-220-64	210	130-890-91	189, 190, 191, 192, 194	141-006-000	285
043-024-101	389	110-006-10	319	120-006-97	116	130-221-50	211	130-890-96	194, 290, 291	141-006-001	285
043-024-150	389	110-007-01	318	120-100-00	422	130-221-51	211	130-890-99	193, 195, 290, 291	141-007-000	285
043-260-09	398	110-007-02	318	120-100-01	422	130-221-52	211			141-007-001	285
043-260-12	398	110-007-10	319	120-100-21	91	130-221-53	211			141-008-000	285
043-350-12	398	110-008-01	318	120-100-40	91	130-221-54	211	130-940-20	158	141-008-001	285
043-350-13	398	110-008-02	318	120-100-70	91	130-221-60	211	130-940-71	158	141-009-000	285
043-350-18	399	110-008-10	319	120-101-21	93	130-221-61	211	130-941-20	158	141-009-001	285
043-350-20	396	110-100-99	319	120-101-41	93	130-221-62	211	130-941-71	158	141-010-000	285
043-500-04	397	115-420-000	85	120-101-60	100	130-221-63	211	130-942-20	160	141-010-001	285
043-500-12	399	115-420-014	85	120-101-71	93	130-221-64	211	130-942-70	160	141-011-000	285
043-500-20	396	115-420-100	85	120-102-21	94	130-340-90	292, 293	130-943-20	160	141-011-001	285
043-500-22	399	116-004-72	261	120-102-40	94	130-340-91	292, 293	130-943-70	160	141-012-000	285
043-700-04	397	116-005-71	261	120-102-71	94	130-340-93	174, 175, 177, 292, 293	130-945-20	158	141-012-001	285
043-700-20	396	116-035-72	349	120-103-220	89			130-945-70	158	141-013-000	286
043-700-22	400	116-036-72	349	120-103-250	89	130-340-94	174, 175, 177, 292, 293	130-950-20	163	141-013-001	286
043-700-42	396	116-039-72	379	120-103-270	89			130-950-70	163	141-014-000	286
100-001-000	70	116-042-52	349, 379	120-103-300	89	130-340-95	174, 175, 177	130-951-20	163	141-014-001	286
100-001-002	70	116-043-96	349	120-103-400	89	130-350-40	181	130-951-70	163	141-015-000	286
100-001-003	70	116-044-50	349	120-104-271	94	130-350-70	181	130-952-70	163	141-015-001	286
100-001-004	70	116-045-72	349	120-104-301	94	130-400-01	200	130-955-20	164	141-017-000	286
100-001-005	70	116-046-52	349	120-104-401	94	130-400-02	200	130-955-70	164	141-017-001	286
100-001-012	70	116-047-70	265	120-105-270	97	130-400-03	200	130-956-20	164	141-018-000	286
100-001-062	70, 71	116-048-70	349	120-105-300	97	130-400-04	200	130-956-70	164	141-018-001	286
100-002-000	71	116-049-70	349	120-105-400	97	130-400-05	200	130-957-70	164	141-019-000	286
100-002-001	71	116-051-71	261	120-106-900	100	130-400-06	200	130-960-20	165	141-019-001	286
100-002-002	71	116-052-70	261	120-107-950	101	130-400-99	200, 201	130-960-70	165	141-020-000	286
100-002-012	71	116-056-70	265	120-107-960	101	130-401-01	200	130-961-20	165	141-020-001	286
100-004-000	83	116-057-70	265	120-107-970	101	130-401-02	200	130-961-70	165	141-021-000	286
100-004-003	83, 301, 303	116-058-70	313	120-107-980	101	130-401-03	200	130-962-70	165	141-021-001	286
100-004-012	83	116-059-70	341	120-108-890	99	130-401-04	200	140-004-51	289	141-022-000	287
100-004-062	83	116-060-71	341	120-109-880	99	130-401-05	200	140-012-22	293	141-022-001	287
100-005-000	74	116-061-70	340	120-110-270	90	130-403-01	201	140-012-42	293	141-023-000	287
100-005-002	74	116-062-70	340	120-110-300	90	130-403-02	201	140-012-72	293	141-023-001	287
100-005-013	74	120-001-01	111, 113, 115, 117	120-110-400	90	130-403-03	201	140-013-22	293	141-024-000	287
100-005-052	74	120-001-02	111, 113, 115, 117	120-111-270	90	130-403-04	201	140-013-42	293	141-024-001	287
100-005-062	74	120-001-03	113	120-111-300	90	130-403-05	201	140-013-72	293	141-025-000	287
100-005-063	74	120-001-04	117	120-111-400	90	130-404-01	201	140-014-51	289	141-025-001	287
100-005-100	74	120-001-05	111, 113, 115, 117	120-112-250	92	130-404-02	201	140-015-21	290	141-026-000	287
100-006-000	76	120-001-20	112	120-112-270	92	130-404-03	201	140-015-71	290	141-026-001	287
100-006-002	76	120-001-70	112	120-112-300	92	130-404-04	201	140-016-21	291	141-027-000	287
100-006-013	76	120-001-81	112	120-112-400	92	130-404-05	201	140-016-41	291	141-027-001	287
100-006-062	76	120-001-82	112	120-112-650	92	130-405-01	202	140-016-71	291	141-028-000	287
100-006-063	76	120-001-83	113	120-113-250	92	130-405-02	202	140-016-90	290, 291	141-028-001	287
100-006-100	76	120-001-84	113	120-113-270	92	130-405-03	202	140-017-22	292	141-029-100	287
100-007-000	82	120-001-85	113	120-113-300	92	130-405-04	202	140-017-42	292	141-029-101	287
100-007-013	82	120-001-86	113	120-113-400	92	130-405-05	202	140-017-72	292	141-029-200	287
100-007-025	82	120-001-87	112	120-113-650	92	130-405-06	202	140-017-90	292, 293	141-029-201	287
100-007-063	82	120-001-88	112	120-114-270	98	130-406-01	202	140-018-22	292	141-029-300	287
100-007-100	82	120-001-89	112	120-114-300	98	130-406-02	202	140-018-42	292	141-029-301	287
100-008-000	48, 50	120-001-89	112	120-114-400	98	130-406-03	202	140-018-72	292	141-103-100	282
100-008-013	48	120-001-90	112	120-116-890	98	130-406-04	202	140-018-82	292	141-103-200	282
100-008-025	48, 50	120-001-91	112	120-118-270	95	130-406-05	202	140-020-41	295	141-103-300	282
100-008-063	48	120-001-92	113	120-118-300	95	130-406-06	202	140-020-71	295	141-104-100	282
100-008-100	48, 50	120-001-94	113	120-118-400	95	130-407-01	203	140-020-90	295	141-104-200	282
100-008-200	49, 51	120-001-95	113	120-118-400	95	130-407-02	203	140-021-41	295	141-104-300	282
100-009-000	50	120-001-96	112	120-119-270	95	130-407-03	203	140-021-71	295	141-105-000	282
100-009-013	50	120-001-97	112	120-119-300	95	130-408-01	203	140-022-21	290	141-105-001	282
100-009-063	50	120-002-60	112	120-119-400	95	130-408-02	203	140-022-71	290	141-106-000	282
100-010-000	84	120-002-81	112	130-001-40	168	130-408-03	203	140-023-21	291	141-106-001	282
100-010-001	84	120-002-82	112	130-001-70	168	130-409-01	204	140-023-41	291	141-107-000	282
100-010-013	84	120-002-89	112	130-002-40	169	130-409-02	204	140-023-71	291	141-107-001	282
100-010-100	84	120-002-91	112	130-002-70	169	130-409-03	204	140-026-50	288	141-107-001	282
100-012-000	28	120-003-40	169	130-003-40	169	130-410-01	204	140-027-50	289	141-108-000	282
100-012-013	28	120-003-70	114	130-003-70	169	130-410-02	204	140-028-50	288	141-108-001	282
100-012-063	28	120-003-88	114	130-105-20	197	130-410-03	204	140-029-50	289	141-109-000	283
100-012-100	28	120-003-89	114	130-106-20	196	130-411-01	205	140-030-50	288	141-109-001	283
100-013-000	32	120-003-88	114	130-106-70	196	130-411-02	205	140-031-50	288	141-110-000	283
100-013-013	32	120-003-90	114	130-107-20	196	130-411-03	205	140-036-20	290	141-110-001	283
100-013-025	32	120-003-91	114	130-110-20	156	130-412-01	205	140-036-70	290	141-111-000	282
100-013-063	32	120-003-95	114	130-110-70	156	130-412-02	205	140-037-20	290	141-111-001	282
100-013-100	32	120-003-96	114	130-110-99	156	130-412-03	205	140-037-70	290	141-112-000	283
100-014-000	52	120-003-97	114	130-110-99	156	130-413-01	207	140-040-21	291	141-112-001	283
100-014-013	52	120-003-98	115	130-200-50	208	130-413-02	207	140-040-71	291	141-119-000	283
100-014-025	52	120-004-60	114	130-201-00	208	130-413-03	207	140-040-90	289, 291	141-1	

## Index nach Artikelnummer

160-021-72	234	161-016-71	251	180-307-70	376	359-180-013	40	960-226-000	36	25817-050-73	157
160-021-99	234	161-017-71	251	180-308-50	343	359-180-022	40	960-226-100	37	25817-051-72	325
160-022-70	234	161-018-71	251	180-310-50	343	359-180-023	40	960-228-000	36	25817-052-72	325
160-024-00	235	161-019-71	251	180-312-70	352	359-180-024	40	960-228-100	37	25817-053-71	347
160-024-72	234	161-020-71	255	180-313-70	352	359-200-01	316	960-330-000	54	25817-054-71	351
160-024-99	234, 235	161-021-71	255	180-314-70	353	359-200-02	316	960-330-203	54	25817-055-71	329
160-025-70	234	161-022-71	255	180-315-70	353	359-200-03	317	960-350-000	58	25817-056-73	157
160-026-72	234	161-023-71	255	185-001-60	307	359-210-012	46	960-350-001	58	25817-057-73	157
160-027-72	235	161-024-71	255	185-001-95	307	359-210-013	46	960-350-214	58	25817-058-41	172
160-027-99	235	161-034-70	251	185-001-96	307	359-210-025	47	3471-000-00	422	25817-058-71	172
160-028-70	235	161-035-70	251	185-001-97	307	359-225-01	316	3471-000-40	422	25817-061-72	215
160-029-72	235	161-036-70	251	185-001-98	307	359-225-02	316	3471-000-50	422	25817-062-72	215
160-031-71	227	161-037-70	251	185-001-99	307	359-226-013	36	3692-001-01	319	25817-063-43	215
160-031-98	226, 227	161-038-70	251	185-002-60	307	359-228-012	36	4401-040-084	67, 69	25817-063-74	215
160-031-99	226, 227	161-039-70	255	185-003-41	301	359-228-013	36	4401-040-085	67, 69	25817-065-20	179
160-032-71	226	161-040-70	255	185-003-71	301	359-330-013	54	6682-040-120	66	25817-065-40	179
160-033-40	263	161-041-70	255	185-004-41	301	359-350-012	58	6682-040-121	66	25817-065-70	179
160-033-70	263	161-042-70	255	185-004-71	301	359-350-013	58	6682-040-122	66	25817-066-40	179
160-035-70	233	161-043-70	255	185-005-41	301	359-350-014	58	6682-040-123	66	25817-066-70	179
160-036-70	233	161-044-70	273	185-005-71	301	359-350-023	58	6682-040-124	69	25817-067-40	180
160-036-99	233	161-045-70	272	185-006-41	301	359-350-024	58	6682-040-125	60	25817-067-70	180
160-037-72	235	161-046-70	273	185-006-71	301	411-096-062	26	6682-040-126	60	25817-068-40	180
160-040-70	229	161-047-70	272	185-160-41	303	411-096-063	26	6682-040-127	66	25817-068-70	180
160-041-70	230	161-050-40	296	185-162-41	303	411-175-062	30, 72	6682-040-128	66	25817-070-70	181
160-042-70	230	161-050-70	296	185-165-40	305	411-175-063	30	6682-040-129	66	25817-071-72	330
160-043-70	229	161-051-40	296	185-165-98	305	411-175-083	30, 72	6682-040-130	66	25817-072-71	328
160-051-70	299	161-051-70	296	185-165-99	305	411-175-163	72, 84	6682-040-131	66	25958-120-07	422
160-052-70	299	161-052-40	296	185-166-40	305	411-180-062	40	6682-040-132	66	26491-040-075	67
160-053-70	299	161-052-70	296	190-001-001	103	411-180-063	40	6682-040-133	66	26491-040-080	67
160-054-95	299	161-053-40	296	200-001-040	390	411-180-064	40	6682-096-000	26	26491-040-085	67, 69
160-054-96	299	161-053-70	296	200-001-060	390	411-210-062	46	9321-008-70	309	26491-045-100	72
160-054-97	299	161-054-70	267	200-001-090	391	411-210-063	46	9321-014-98	213	26491-096-100	26, 317
160-054-98	299	161-055-70	267	200-001-120	391	411-210-065	46	9321-015-98	213	26491-175-100	30
160-055-70	249	161-056-70	267	200-002-150	391	411-226-062	36, 85	23294-102-99	311	26491-180-100	41
160-056-91	222	161-101-10	275	200-002-240	392	411-226-063	36, 85	23294-103-99	311	26491-210-100	47
160-057-40	221	161-101-11	275	200-002-320	392	411-330-063	52, 54	23294-105-89	311, 388	26524-003-71	355
160-057-70	221	170-012-41	313	200-002-480	392	411-350-062	58	23294-105-99	311, 388	26524-007-71	379
160-058-40	221	170-020-70	310	200-003-026	393	411-350-063	58	23943-001-71	244	26524-008-71	351
160-058-70	221	170-021-70	310	200-003-051	393	411-350-064	58	23943-002-71	244	26524-009-71	327
160-059-40	217	170-023-70	310	200-003-101	393	411-350-074	58	23943-003-71	245	26524-010-71	327
160-059-70	217	170-024-70	310	200-003-200	394	556-050-50	406	23943-004-71	245	27025-003-91	155, 207
160-060-40	217	170-026-50	311	200-004-001	401	660-011-99	364	23943-005-71	246	27025-003-94	177, 180, 181, 187
160-060-70	217	170-026-55	311	200-006-002	400	660-111-70	364	23943-006-71	246		
160-060-90	219	180-011-00	356, 357	200-007-001	400	660-113-70	369	23943-007-70	247	27025-003-96	174
160-061-40	217	180-011-70	356	200-010-051	394	772-521-050	319	23943-008-70	247	27025-003-97	175
160-061-70	217	180-021-70	357	200-010-081	395	936-016-000	78	23943-016-71	168	27025-003-98	225
160-062-40	217	180-031-70	357	200-010-161	395	936-016-013	78	23943-017-72	246	27440-350-05	397
160-062-70	217	180-200-72	370	200-011-080	406	936-016-063	78	23943-018-72	244	27440-700-05	397
160-062-90	219	180-200-99	370, 371	200-018-010	402	936-016-083	78	23943-019-71	244	30246-001-72	241
160-063-91	222	180-201-72	371	200-019-010	402	936-016-100	78	23943-020-72	244	30246-002-41	242
160-064-40	221	180-202-72	371	200-020-035	394	936-016-110	78	23943-021-71	246	30246-002-71	242
160-064-70	221	180-202-99	371	200-022-012	390	936-026-000	80	23943-022-71	245	30246-003-71	243
160-065-40	221	180-203-71	369	200-240-024	414	936-026-013	80	23943-023-71	246	30246-004-71	243
160-065-70	221	180-204-71	333	210-001-01	412	936-026-033	38, 80	23943-024-71	245	30246-005-71	241
160-070-09	271, 297	180-204-98	333	210-003-000	412	936-026-053	38, 80	23943-025-70	247	30246-020-71	242
160-070-70	271	180-204-99	333	210-004-000	420	936-026-063	38, 80	23943-026-70	247	30246-021-41	242
160-071-70	271	180-205-71	362	210-004-079	421	936-026-083	38, 80	23943-027-70	247	30246-021-71	242
160-072-70	271	180-206-71	363	210-004-089	421	936-026-110	81	23943-028-71	245	30246-022-71	242
160-073-70	271	180-207-71	363	210-005-000	420	936-040-000	38	23943-029-70	247	30246-030-71	241
160-074-70	271	180-208-70	362	210-006-000	414	936-040-002	67, 69	23943-030-71	245	30246-031-71	241
160-075-70	271	180-209-71	373	210-007-000	411	936-040-004	64	23943-031-70	247	30246-250-01	241
160-076-70	271	180-210-71	366	210-008-000	413	936-040-012	67, 69	23943-032-71	245	30246-300-01	242
160-077-70	271	180-210-99	366, 367	210-010-000	419	936-040-014	64	23943-033-72	168	30285-000-00	422
160-078-70	271	180-211-71	367	210-011-000	415	936-040-015	64	25716-008-79	409	30285-001-00	422
160-079-70	271	180-212-71	366	210-011-900	415	936-040-034	60	25716-008-89	410	AR-121-005-51	317
160-080-70	271	180-212-99	366, 367	211-001-000	301, 235	936-040-044	68	25716-008-99	409	CI-592-512-000	422
160-081-70	271	180-213-71	367	211-002-000	407	936-040-050	65, 68	25716-009-99	408	CI-595-219-000	422
160-082-70	271	180-214-70	323	290-001-01	423	936-040-053	65, 68	25716-012-99	416	CR-185-106-85	319
160-083-70	271	180-215-70	323	290-002-00	60	936-040-055	65, 68	25716-013-99	416	DL/24V-RW-400	88
160-084-70	271	180-216-70	365	290-012-001	423	936-040-065	65, 68	25716-014-99	417	DL/24V-WW-400	88
160-085-70	271	180-216-99	365	290-012-002	423	936-040-068	65, 68	25716-015-99	417	EM-119-016-109	423
160-086-70	271	180-217-70	365	290-012-003	423	936-040-074	60, 65	25716-016-99	418	LS-P-1-1	386
160-087-70	271	180-218-71	333	290-016-00	26, 28, 32, 37, 39, 43, 44, 47, 79	936-040-075	60, 65	25716-017-99	418	M-990-2	423
160-088-70	271	180-220-72	337	290-018-00	48, 50, 58	936-040-076	65	25716-019-99	419	MW-AA-220-06-S	319, 386
160-089-70	271	180-221-71	337	290-019-00	52, 54, 56, 60, 67, 69, 81, 82	936-040-077	65	25716-020-99	419	MW-TNG-60-24	319, 386
160-090-40	277	180-222-72	337	290-019-00	52, 54, 56, 60, 67, 69, 81, 82	936-040-078	65	25716-021-99	418	OP-9907799	423
160-091-70	225	180-223-71	337	290-020-00	67, 69	936-040-080	38	25716-022-99	410	PS-V24-W24-X2	386
160-091-99	225	180-230-40	358	290-030-00	215	936-040-094	64	25716-024-99	405	RI-111-907-98	189, 191, 194
160-092-50	259	180-231-40	359	290-030-00	215	936-040-095	65	25798-350-03	396	RI-111-909-99	423
160-093-50	259	180-232-40	359	290-100-00	356, 357, 369	936-040-100	39	25817-001-72	330	UD-043-100-01	303
160-094-50	259	180-235-70	334	290-101-00	422	936-040-215	64	25817-001-99	330, 331	UD-043-101-00	301
160-110-70	237	180-236-70	334	290-102-00	422	936-200-000	42	25817-003-71	329		



































































## Zeichenerklärung

	inklusive Treiber		Decke: Pendel		Betriebsspannung, 220 – 240 V, 50 – 60 Hz
	exklusive Treiber		Decke: Einbau		Primäre Betriebsspannung 220 – 240 V, 50 – 60 Hz
	Schutzklasse 1		Wand: Einbau		Betriebsspannung 24 V dc
	Schutzklasse 2		Wand, Boden: Einbau		Primäre Betriebsspannung 24 V dc
	Schutzklasse 3		Wand: Aufbau		Sekundäre Betriebsspannung 24 V dc
	Ein/Aus		Decke, Wand, Boden: Einbau, Aufbau		Berührungs- und Fremdkörper- schutz / Wasserschutz
	DALI dimmbar		Decke: Aufbau		Schutzniveau gegen Schlagkraft
	DALI 2 dimmbar		Decke, Wand: Aufbau		weiss
	Phasenabschnitt dimmbar		Decke: Einbau, Aufbau, Pendel		schwarz
	Notlichtelement		Decke, Wand: Aufbau, Pendel		silber
	HF-Sensor		Boden: Einbau		silbergrau
	Dimmen über Taster		Boden: Aufbau		alu-gebürstet
	TouchDim		Decke, Wand, Boden: Aufbau		alu-glänzend
	Funk		Möbelbeleuchtungen		chrom
	Bluetooth		Decke: Pendel		grau
	Pulsweitenmodulation (PWM)		Produkt auch im Aussenbereich einsetzbar		anthrazit
	Amplitudenmodulation (AM)		Ø Bohrloch		champagner
	Geeignet zur Montage auf z.B. Holz oder Holzwerkstoffen		Deckenausschnitt		gold
	Umgebungstemperatur		Energieeffizienzklasse Leuchtmittel		bronze
			Energieeffizienzklasse Leuchtmittel in Leuchte		

### Was bedeutet ein Punkt vor der Preisangabe?

Wir sind bekannt für eine schnelle Lieferung: Bestellungen bis 14.00 Uhr werden noch am gleichen Tag verschickt. Artikel zum konfektionieren haben eine Lieferzeit von 2 bis 5 Tagen. Diese sind am schwarzen Punkt vor der Preisangabe zu erkennen. Ist der Punkt rot können wir Ihnen die Lieferzeit nur auf Anfrage mitteilen.

Art.-Nr.	CHF
160-027-71	99.00
160-037-70	159.00

Lieferzeit: 2 bis 5 Tage

Lieferzeit: auf Anfrage

---

# Impressum

---

## Informationen

- Mit Erscheinen dieses Kataloges verlieren alle bisher veröffentlichten Preise ihre Gültigkeit.
- Die angegebenen Preise sind in Schweizer Franken, exklusiv MWSt. und vRG.
- Preis-, Konstruktions- und Massänderungen sowie Änderungen des Lieferprogrammes bleiben vorbehalten.
- Abbildungen und Angaben sind unverbindlich in Farbe, Form und Ausführung.
- Es gelten die allgemeinen Geschäftsbedingungen der unex lighting AG ([www.unex-lighting.com](http://www.unex-lighting.com)).

---

## Herausgeber

- unex lighting AG  
Flüelastrasse 12  
CH-8048 Zürich  
+41 44 404 22 22  
[www.unex-lighting.com](http://www.unex-lighting.com)

## Copyright

- © unex lighting AG, 2022

## Bildnachweise

- unex lighting AG
- SeLED AG
- fit & wellness concept GmbH





unex lighting AG  
Flüelastrasse 12  
CH-8048 Zürich

+41 44 404 22 22  
[www.unex-lighting.com](http://www.unex-lighting.com)  
[info@unex-lighting.com](mailto:info@unex-lighting.com)